

### Item description

- Protected against mismatching and maintenance-free
- Push-in CAGE CLAMP® spring pressure connection technology allows solid conductors to be simply pushed into a unit
- Compact design with 4.4 mm pole spacing
- When assembled, the installation connectors complies with IP40 and are suitable for easily accessible areas

### Note:

All connectors for mounted installations (snap-in versions for lighting fixtures or devices, all types of PCB and distribution connectors) are factory-equipped with locking levers to ensure plugs and sockets are securely locked. Additional locking levers are only required for flying leads (plug /socket).

### Note on mismatching protection:

All WINSTA® components are 100% protected against mismatching when:

- a.) plugging different numbers of poles
- b.) plugging while rotated 180
- c.) plugging while laterally staggered
- d.) plugging one pole

### Safety information 1:

Application note for the U.S. market (USR): Some versions may also be used for current interruption in accordance with the UL certificate in select applications with currents below 5 A and voltages up to 600 V. For further information, please contact your local sales office.

Subject to changes. Please also observe the further product documentation!



## Data

### Electrical data

Note on Contact Resistance	approx. 1 mΩ of contact resistance approx. 0.25 mΩ contact transition plug/socket
----------------------------	---

### Ratings per IEC/EN 60664-1

Ratings per	IEC/EN 60664-1
Rated voltage (III / 3)	250 V
Rated impulse voltage (III / 3)	4 kV
Rated current	16 A
Legend (ratings)	(III / 3) ≙ Overvoltage category III / Pollution degree 3

### Approvals per UL 1977

Rated voltage per UL 1977 (factory wiring only)	600 V
Rated current per UL 1977 (factory wiring only)	14 A

### Connection data

Connection technology	Push-in CAGE CLAMP®
Actuation type	Operating tool Push-in
Nominal cross section	1,5 mm <sup>2</sup>
Solid conductor	0,25 ... 1,5 mm <sup>2</sup> / 22 ... 16 AWG
Solid conductor, push-in termination	0,75 ... 1,5 mm <sup>2</sup> / 20 ... 16 AWG
Stranded conductor	0,25 ... 1 mm <sup>2</sup> / 22 ... 18 AWG
Fine-stranded conductor	0,25 ... 1,5 mm <sup>2</sup> / 22 ... 16 AWG
Fine-stranded conductor with ferrule with plastic collar	0,25 ... 0,75 mm <sup>2</sup> / 22 ... 20 AWG
Fine-stranded conductor with ferrule without plastic collar	0,25 ... 0,75 mm <sup>2</sup> / 22 ... 20 AWG
Fine-stranded conductor with ferrule, push-in termination, from	0,75 mm <sup>2</sup> / 20 AWG
Strip length	9 mm / 0.35 inch
Note (strip length)	see also packaging or instructions
No. of poles	2
Total number of connection points	2
Total number of potentials	2
Conductor entry direction to mating direction	0°

Subject to changes. Please also observe the further product documentation!

WAGO Kontakttechnik GmbH & Co. KG  
 Hansastr. 27  
 32423 Minden  
 Phone: +49571 887-0 | Fax: +49571 887-169  
 Email: [info.de@wago.com](mailto:info.de@wago.com) | Web: [www.wago.com](http://www.wago.com)

Do you have any questions about our products?  
 We are always happy to take your call at +49 (571) 887-44222.



## Geometrical Data

Pin spacing	4,4 mm / 0.173 inch
Width	10,4 mm / 0.409 inch
Height	11,7 mm / 0.461 inch
Depth	34,1 mm / 1.343 inch

## Mechanical data

Technologie	DALI
Coding	I
Mating force of a plug-in connection	approx. 20 ... 70 N (depending on pole number)
Retention force of a plug-in connection	Locked: > 80 N
Unmating force of a plug-in connection	Unlocked: approx. 20 ... 70 N (depending on pole number)
Number of mating cycles	200, without resistive load 100, with resistive load $I_N = 16$ A, tested (1.5 mm <sup>2</sup> /AWG 16)
Marking	+ -
Protection class	IP20
Note on protection class	IP40 when mated with strain relief housing
Potential marking	+ -
Application	Lighting management

## Plug connection

Contact type (pluggable connector)	Male connector/plug
Connector connection type	for conductor
Mismating protection	Yes
Locking of plug-in connection	locking lever
Locking lever	no

## Material Data

Color	blue
Insulating material	Polyamide 66 (PA 66)
Clamping spring material	Chrome nickel spring steel (CrNi)
Contact material	Copper or copper alloy (surface-treated)
Fire load	0.056 MJ

Subject to changes. Please also observe the further product documentation!

Weight	2.5 g
--------	-------

### Environmental Requirements

Processing temperature	-5 ... +40 °C
Continuous operating temperature	-35 ... +85 °C
Note on Continuous Service Temperature	Insulating parts for temperatures $\leq$ 105 °C

### Commercial data



Product Group	20 (WINSTA)
Packaging type	BOX
Country of origin	PL
GTIN	4055143548502
Customs Tariff No.	85366990990

### Approvals / Certificates

#### Country specific Approvals

Logo	Approval	Additional Approval Text	Certificate name
	<b>CCA</b> DEKRA Certification B.V.	EN 61535	71-102984
	<b>CCA</b> DEKRA Certification B.V.	IEC 61535	NL-49482

#### Ship Approvals

Logo	Approval	Additional Approval Text	Certificate name
	<b>ABS</b> American Bureau of Shipping	Steel Vessel Rules	19-HG1869855-PDA
	<b>DNV GL</b> Det Norske Veritas, Germanischer Lloyd	-	TAE00001Z6
	<b>LR</b> Lloyds Register	EN 61535	08/20047 (E2)

Subject to changes. Please also observe the further product documentation!

UL-Approvals

Logo	Approval	Additional Approval Text	Certificate name
	cURus Underwriters Laboratories Inc.	UL 1977	E45171

Counterpart

	<b>Item no.890-1102</b> Socket; 2-pole; Cod. I; 1,50 mm <sup>2</sup> ; blue	<a href="http://www.wago.com/890-1102">www.wago.com/890-1102</a>
	<b>Item no.890-1617</b> T-distribution connector; 2-pole; Cod. I; 1 input; 2 outputs; 2 locking levers; blue	<a href="http://www.wago.com/890-1617">www.wago.com/890-1617</a>
	<b>Item no.890-1620</b> T-distribution connector; 2-pole; Cod. I; 1 input; 2 outputs; 3 locking levers; for flying leads; blue	<a href="http://www.wago.com/890-1620">www.wago.com/890-1620</a>
	<b>Item no.890-1904</b> 3-way distribution connector; 2-pole; Cod. I; 1 input; 3 outputs; blue	<a href="http://www.wago.com/890-1904">www.wago.com/890-1904</a>
	<b>Item no.890-1907</b> 5-way distribution connector; 2-pole; Cod. I; 1 input; 5 outputs; blue	<a href="http://www.wago.com/890-1907">www.wago.com/890-1907</a>
	<b>Item no.890-2102</b> Snap-in socket; 2-pole; Cod. I; 1,50 mm <sup>2</sup> ; blue	<a href="http://www.wago.com/890-2102">www.wago.com/890-2102</a>
	<b>Item no.890-3102</b> Socket for PCBs; straight; 2-pole; Cod. I	<a href="http://www.wago.com/890-3102">www.wago.com/890-3102</a>

Subject to changes. Please also observe the further product documentation!



**Item no.890-3102/011-000**  
Socket for PCBs; angled; 2-pole; Cod. I

[www.wago.com/890-3102/011-000](http://www.wago.com/890-3102/011-000)



**Item no.891-8982/006-101**  
pre-assembled interconnecting cable; Eca; Socket/plug; 2-pole; Cod. I; H05VV-F 2 x 1.5 mm<sup>2</sup>; 1 m; 1,50 mm<sup>2</sup>; blue

[www.wago.com/891-8982/006-101](http://www.wago.com/891-8982/006-101)



**Item no.891-8982/106-101**  
pre-assembled connecting cable; Eca; Socket/open-ended; 2-pole; Cod. I; H05VV-F 2 x 1.5 mm<sup>2</sup>; 1 m; 1,50 mm<sup>2</sup>; blue

[www.wago.com/891-8982/106-101](http://www.wago.com/891-8982/106-101)

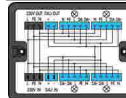

**Item no.899-631/181-000**  
Distribution box; 230 V + DALI; 2 inputs; 6 outputs; Cod. A, I; MINI, MIDI; black

[www.wago.com/899-631/181-000](http://www.wago.com/899-631/181-000)

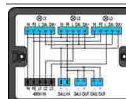

**Item no.899-631/455-000**  
Distribution box; 400 V + DALI; 2 inputs; 5 outputs; Cod. A, I; MINI, MIDI; black

[www.wago.com/899-631/455-000](http://www.wago.com/899-631/455-000)

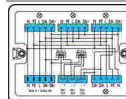

**Item no.899-681/146-000**  
Distribution box; 230 V + DALI; 1 input; 7 outputs; Cod. A, B, I; MINI, MIDI; white

[www.wago.com/899-681/146-000](http://www.wago.com/899-681/146-000)

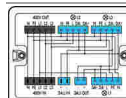

**Item no.899-681/147-000**  
Distribution box; 400 V + DALI; 2 inputs; 5 outputs; Cod. A, I; MINI, MIDI; white

[www.wago.com/899-681/147-000](http://www.wago.com/899-681/147-000)

## Compatible products

### tools

**Item no.: 210-719**  
Operating tool; Blade: 2.5 x 0.4 mm; with a partially insulated shaft

[www.wago.com/210-719](http://www.wago.com/210-719)

**Item no.: 890-382**  
Operating tool; 2-way; green

[www.wago.com/890-382](http://www.wago.com/890-382)

### Locking lever

**Item no.: 890-101**  
Locking lever; for manual operation; black

[www.wago.com/890-101](http://www.wago.com/890-101)

**Item no.: 890-111**  
Locking lever; for flying leads; for tool operation; black

[www.wago.com/890-111](http://www.wago.com/890-111)



**Item no.: 890-121**  
Locking lever; for manual operation; white

[www.wago.com/890-121](http://www.wago.com/890-121)







**Item no.: 890-131**

Subject to changes. Please also observe the further product documentation!

Locking lever; for flying leads; for tool operation; white

[www.wago.com/890-131](http://www.wago.com/890-131)

#### Strain relief plate

	<p><b>Item no.: 890-502</b> Strain relief housing; 2-pole; with locking clip; for 1 cable; 3.8 ... 8.2 mm; 30 mm; black</p>	<a href="http://www.wago.com/890-502">www.wago.com/890-502</a>
	<p><b>Item no.: 890-502/342-000</b> Strain relief housing; 2-pole; with locking clip; for 1 cable; 3.8 ... 8.2 mm; 17.5 mm; black</p>	<a href="http://www.wago.com/890-502/342-000">www.wago.com/890-502/342-000</a>
	<p><b>Item no.: 890-512</b> Strain relief housing; 2-pole; with locking clip; for 1 cable; 3.8 ... 8.2 mm; 30 mm; white</p>	<a href="http://www.wago.com/890-512">www.wago.com/890-512</a>
	<p><b>Item no.: 890-512/342-000</b> Strain relief housing; 2-pole; with locking clip; for 1 cable; 3.8 ... 8.2 mm; 17.5 mm; white</p>	<a href="http://www.wago.com/890-512/342-000">www.wago.com/890-512/342-000</a>
<b>assembling</b>		
	<p><b>Item no.: 890-310</b> Mounting carrier; 2- to 5-pole; for flying leads; black</p>	<a href="http://www.wago.com/890-310">www.wago.com/890-310</a>
	<p><b>Item no.: 890-311</b> Mounting carrier; 2- to 5-pole; for flying leads; white</p>	<a href="http://www.wago.com/890-311">www.wago.com/890-311</a>

#### Downloads

##### CAD/CAE-Data

###### CAD data

2D/3D Models 890-1112	<a href="#">URL</a>	<a href="#">Download</a>
-----------------------	---------------------	--------------------------

###### CAE data

EPLAN Data Portal 890-1112	<a href="#">URL</a>	<a href="#">Download</a>
WSCAD Universe 890-1112	<a href="#">URL</a>	<a href="#">Download</a>

#### Installation Notes

Subject to changes. Please also observe the further product documentation!

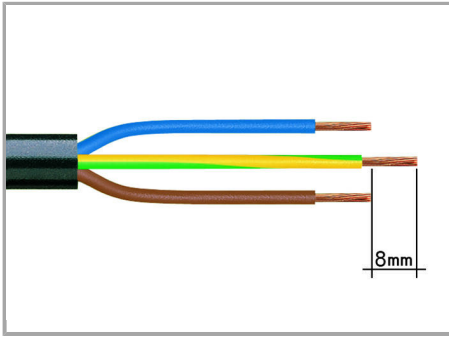

1. Strip length, outer insulation = 30 mm (2-pole), 37 mm (3-pole), 45 mm (4- and 5-pole)

2. Strip length = 9 mm

3. Extended ground conductor = 8 mm

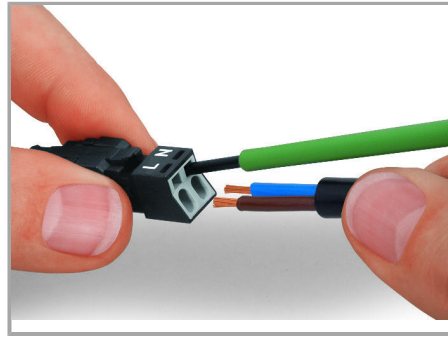

To terminate fine-stranded conductors, open the clamping unit via screwdriver (2.5 mm blade width) and insert a stripped conductor until it hits backstop. Terminate solid conductors by simply pushing them in.

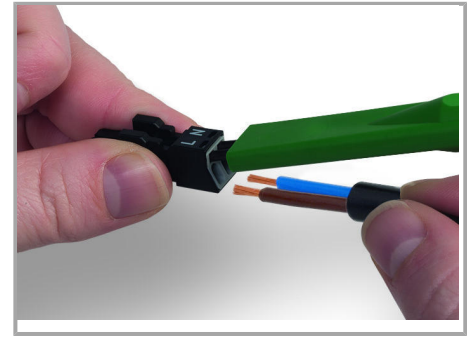

To terminate fine-stranded conductors, open clamping units via operating tool (890-382) and insert stripped conductors until they hit backstop.

Terminate solid conductors by simply pushing them in.

Subject to changes. Please also observe the further product documentation!



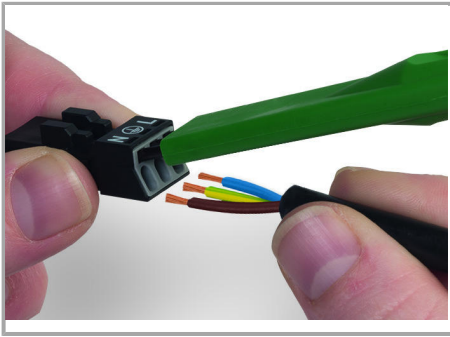

To terminate fine-stranded conductors, open clamping units via operating tool (890-383) and insert stripped conductors until they hit backstop.

Terminate solid conductors by simply pushing them in.

#### Installation

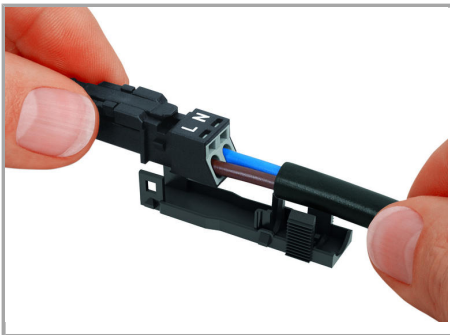

Latch wired connector onto the base of the strain relief housing.

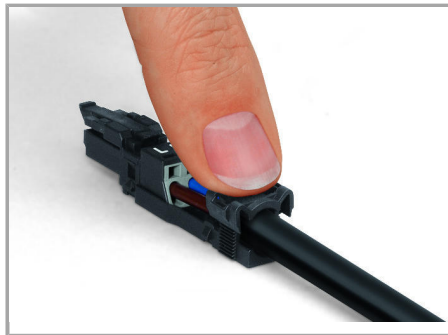

Push down strain relief clamp by hand.



Push down strain relief clamp via 2.5 mm screwdriver alternately on both sides.

Subject to changes. Please also observe the further product documentation!

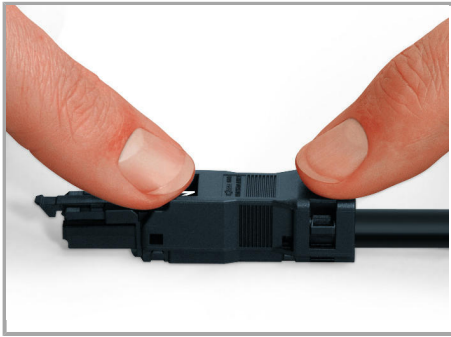

Latch the top of the strain relief housing.



The printed marking of the connector is clearly visible in the openings of the strain relief housing.

## Product family

*WINSTA*® MINI

[Show all products from the family](#)

Subject to changes. Please also observe the further product documentation!