

Data sheet | Item number: 890-105

Socket; with strain relief housing; 5-pole; Cod. A; 1,50 mm²; black

www.wago.com/890-105

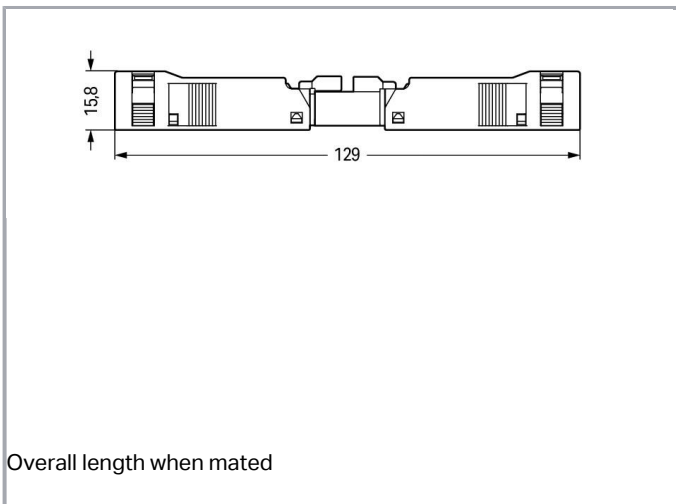
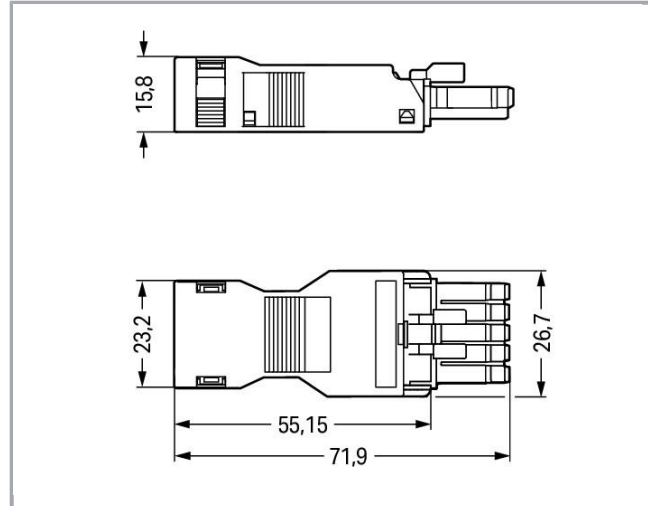

Item description

- Protected against mismatching and maintenance-free
- Push-in CAGE CLAMP® spring pressure connection technology allows solid conductors to be simply pushed into a unit
- Compact design with 4.4 mm pole spacing
- When assembled, the installation connectors complies with IP40 and are suitable for easily accessible areas

Subject to changes. Please also observe the further product documentation!

WAGO Kontakttechnik GmbH & Co. KG
Hansastr. 27
32423 Minden
Phone: +49571 887-0 | Fax: +49571 887-169
Email: info.de@wago.com | Web: www.wago.com

Do you have any questions about our products?
We are always happy to take your call at +49 (571) 887-44222.

**Note:**

All connectors for mounted installations (snap-in versions for lighting fixtures or devices, all types of PCB and distribution connectors) are factory-equipped with locking levers to ensure plugs and sockets are securely locked. Additional locking levers are only required for flying leads (plug /socket).

Note on mismatching protection:

All WINSTA[®] components are 100% protected against mismatching when:

- a.) plugging different numbers of poles
- b.) plugging while rotated 180
- c.) plugging while laterally staggered
- d.) plugging one pole

Safety information 1:

Application note for the U.S. market (USR): Some versions may also be used for current interruption in accordance with the UL certificate in select applications with currents below 5 A and voltages up to 600 V. For further information, please contact your local sales office.

Data**Electrical data**

Note on Contact Resistance	approx. 1 mΩ of contact resistance approx. 0.25 mΩ contact transition plug/socket
----------------------------	---

Ratings per IEC/EN 60664-1

Ratings per	IEC/EN 60664-1
Rated voltage (III / 3)	400 V
Rated impulse voltage (III / 3)	6 kV
Rated current	13 A
Legend (ratings)	(III / 3) ≙ Overvoltage category III / Pollution degree 3

Approvals per UL 1977

Rated voltage per UL 1977 (factory wiring only)	600 V
Rated current per UL 1977 (factory wiring only)	12 A

Connection data

Connection technology	Push-in CAGE CLAMP [®]
Actuation type	Operating tool Push-in
Nominal cross section	1,5 mm ²
Solid conductor	0,25 ... 1,5 mm ² / 22 ... 16 AWG
Solid conductor, push-in termination	0,75 ... 1,5 mm ² / 20 ... 16 AWG
Stranded conductor	0,25 ... 1 mm ² / 22 ... 18 AWG

Subject to changes. Please also observe the further product documentation!

WAGO Kontakttechnik GmbH & Co. KG
 Hansastr. 27
 32423 Minden
 Phone: +49571 887-0 | Fax: +49571 887-169
 Email: info.de@wago.com | Web: www.wago.com

Do you have any questions about our products?
 We are always happy to take your call at +49 (571) 887-44222.



Fine-stranded conductor	0,25 ... 1,5 mm ² / 22 ... 16 AWG
Fine-stranded conductor with ferrule with plastic collar	0,25 ... 0,75 mm ² / 22 ... 20 AWG
Fine-stranded conductor with ferrule without plastic collar	0,25 ... 0,75 mm ² / 22 ... 20 AWG
Fine-stranded conductor with ferrule, push-in termination, from	0,75 mm ² / 20 AWG
Strip length	9 mm / 0.35 inch
Note (strip length)	see also packaging or instructions
No. of poles	5
Total number of connection points	5
Total number of potentials	5
Connectable sheathed cable diameter	6,5 ... 10,5 mm
Conductor entry direction to mating direction	0°
Strip length	45 mm

Geometrical Data

Pin spacing	4,4 mm / 0.173 inch
Width	26,7 mm / 1.051 inch
Height	15,8 mm / 0.622 inch
Depth	71,9 mm / 2.831 inch

Mechanical data

Coding	A
Mating force of a plug-in connection	approx. 20 ... 70 N (depending on pole number)
Retention force of a plug-in connection	Locked: > 80 N
Unmating force of a plug-in connection	Unlocked: approx. 20 ... 70 N (depending on pole number)
Number of mating cycles	200, without resistive load 100, with resistive load $I_N = 16$ A, tested (1.5 mm ² /AWG 16)
Marking	N 1 2 3
Protection class	IP40
Potential marking	N 1 2 3
Application	General mains applications

Plug connection

Contact type (pluggable connector)	Female connector/socket
Connector connection type	for conductor

Subject to changes. Please also observe the further product documentation!

Mismating protection	Yes
Locking of plug-in connection	locking lever
Locking lever	no
Strain relief	strain relief housing

Material Data

Color	black
Insulating material	Polyamide 66 (PA 66)
Clamping spring material	Chrome nickel spring steel (CrNi)
Contact material	Copper or copper alloy (surface-treated)
Fire load	0.29 MJ
Weight	11.9 g

Environmental Requirements

Processing temperature	-5 ... +40 °C
Continuous operating temperature	-35 ... +85 °C
Note on Continuous Service Temperature	Insulating parts for temperatures ≤ 105 °C

Commercial data

Product Group	20 (WINSTA)
Packaging type	BOX
Country of origin	DE
GTIN	4045454232870
Customs Tariff No.	85366990990

Approvals / Certificates



Country specific Approvals

Logo	Approval	Additional Approval Text	Certificate name
	CCA DEKRA Certification B.V.	EN 61535	71- 102984
	CCA DEKRA Certification B.V.	IEC 61535	NL-49482

Ship Approvals

Certificate





Subject to changes. Please also observe the further product documentation!

Logo	Approval	Additional Approval Text	name
	ABS American Bureau of Shipping	Steel Vessel Rules	19- HG1869855- PDA
	DNV GL Det Norske Veritas, Germanischer Lloyd	-	TAE00001Z6
	LR Lloyds Register	EN 61535	08/20047 (E2)

UL-Approvals

Logo	Approval	Additional Approval Text	Certificate name
	cURus Underwriters Laboratories Inc.	UL 1977	E45171

Counterpart

	Item no.890-115 Plug; with strain relief housing; 5-pole; 1,50 mm ² ; black	www.wago.com/890-115
	Item no.890-215 Plug; 5-pole; 1,50 mm ² ; black	www.wago.com/890-215
	Item no.890-715 Snap-in plug; 5-pole; Cod. A; 1,50 mm ² ; black	www.wago.com/890-715
	Item no.890-622 T-distribution connector; 5-pole; Cod. A; 1 input; 2 outputs; 3 locking levers; for flying leads; black	www.wago.com/890-622
	Item no.890-621 T-distribution connector; 5-pole; Cod. A; 1 input; 2 outputs; 2 locking levers; black	www.wago.com/890-621

Subject to changes. Please also observe the further product documentation!



Item no.890-815
Plug for PCBs; straight; 5-pole; Cod. A

www.wago.com/890-815



Item no.890-815/011-000
Plug for PCBs; angled; 5-pole; Cod. A

www.wago.com/890-815/011-000



Item no.890-929
h-distribution connector; 5-pole; Cod. A; 1 input; 2 outputs; outputs on one side; 2 locking levers; black

www.wago.com/890-929



Item no.890-930
h-distribution connector; 5-pole; Cod. A; 1 input; 2 outputs; outputs on one side; 3 locking levers; for flying leads; black

www.wago.com/890-930



Item no.891-8995/006-101
pre-assembled interconnecting cable; Eca; Socket/plug; 5-pole; Cod. A; H05VV-F 5G 1.5 mm²; 1 m; 1,50 mm²; black

www.wago.com/891-8995/006-101



Item no.891-8995/206-101
pre-assembled connecting cable; Eca; Plug/open-ended; 5-pole; Cod. A; H05VV-F 5G 1.5 mm²; 1 m; 1,50 mm²; black

www.wago.com/891-8995/206-101

Compatible products

tools

Item no.: 210-719
Operating tool; Blade: 2.5 x 0.4 mm; with a partially insulated shaft

www.wago.com/210-719



Item no.: 890-385
Operating tool; 5-way; green

www.wago.com/890-385

Locking lever

Item no.: 890-101
Locking lever; for manual operation; black

www.wago.com/890-101



Item no.: 890-111
Locking lever; for flying leads; for tool operation; black

www.wago.com/890-111



Item no.: 890-121
Locking lever; for manual operation; white

www.wago.com/890-121

Item no.: 890-131
Locking lever; for flying leads; for tool operation; white

www.wago.com/890-131

Subject to changes. Please also observe the further product documentation!

shield connection

	Item no.: 890-526 Shield connecting plate; 5-pole; for sockets	www.wago.com/890-526
--	--	--

assembling

	Item no.: 890-310 Mounting carrier; 2- to 5-pole; for flying leads; black	www.wago.com/890-310
	Item no.: 890-311 Mounting carrier; 2- to 5-pole; for flying leads; white	www.wago.com/890-311

Downloads

CAD/CAE-Data

CAD data

2D/3D Models 890-105	URL	Download
----------------------	---------------------	--------------------------

CAE data

WSCAD Universe 890-105	URL	Download
------------------------	---------------------	--------------------------

Installation Notes

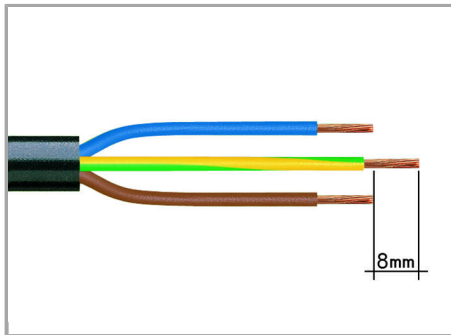

1. Strip length, outer insulation = 30 mm (2-pole), 37 mm (3-pole), 45 mm (4- and 5-pole)

2. Strip length = 9 mm

3. Extended ground conductor = 8 mm

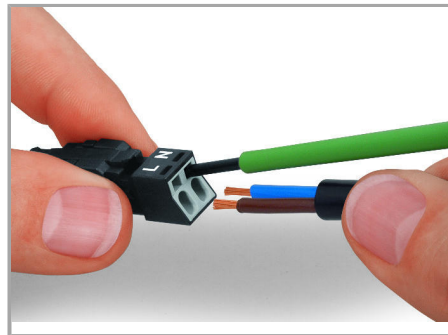

To terminate fine-stranded conductors, open the clamping unit via screwdriver (2.5 mm blade width) and insert a stripped conductor until it hits backstop. Terminate solid conductors by simply pushing them in.

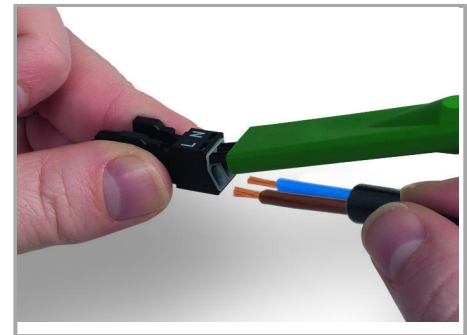

To terminate fine-stranded conductors, open clamping units via operating tool (890-382) and insert stripped conductors until they hit backstop.

Terminate solid conductors by simply pushing them in.

Subject to changes. Please also observe the further product documentation!

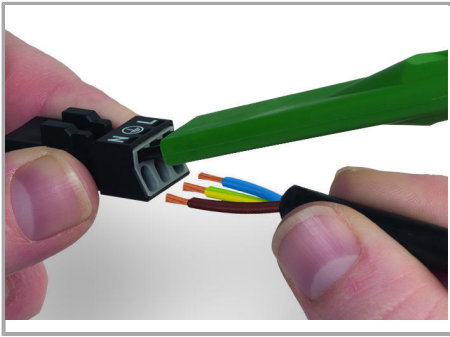

To terminate fine-stranded conductors, open clamping units via operating tool (890-383) and insert stripped conductors until they hit backstop.

Terminate solid conductors by simply pushing them in.

Installation

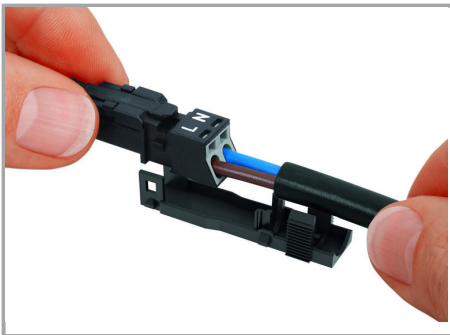

Latch wired connector onto the base of the strain relief housing.

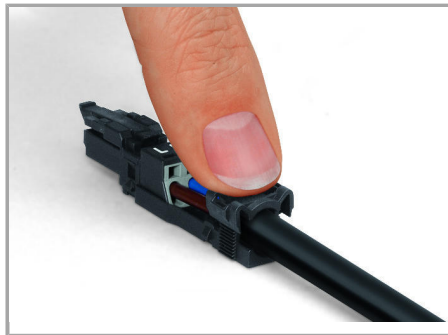

Push down strain relief clamp by hand.



Push down strain relief clamp via 2.5 mm screwdriver alternately on both sides.

Subject to changes. Please also observe the further product documentation!

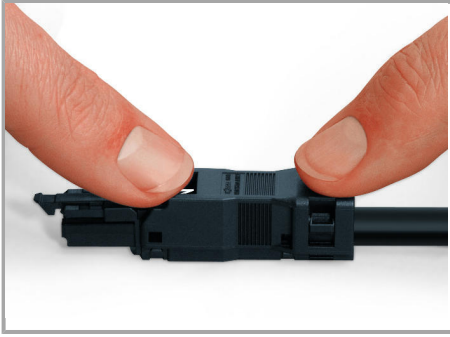

Latch the top of the strain relief housing.

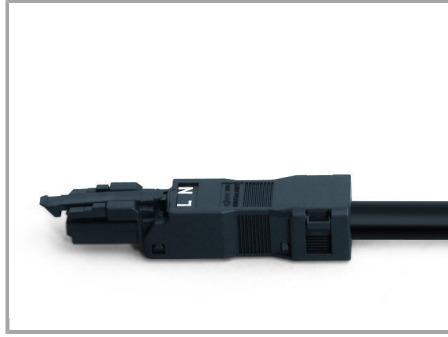

The printed marking of the connector is clearly visible in the openings of the strain relief housing.

Shield Connection

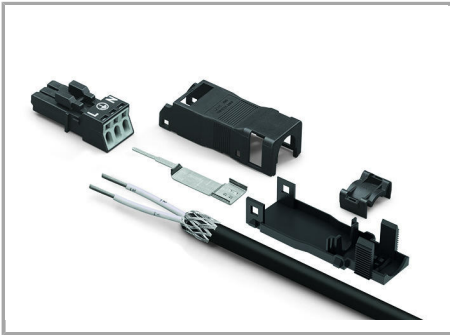

Connector with shield termination

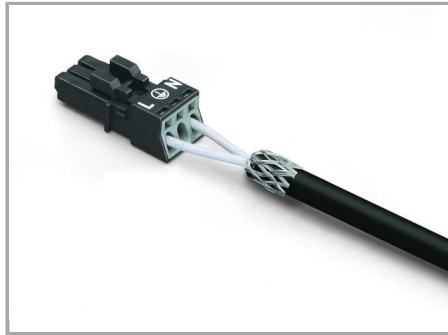

Apply the shield to the rubber cable.

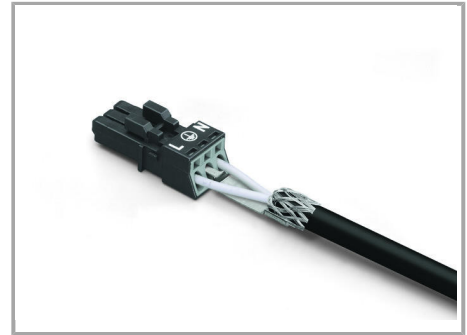

Push the shield connecting plate into the connector until fully inserted.

Strip length, outer insulation = 30 mm

Shield length = 8 mm

Subject to changes. Please also observe the further product documentation!

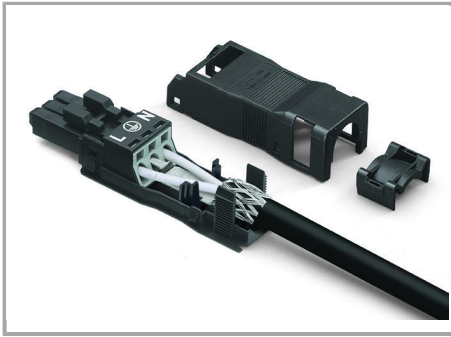

First insert wired connector into strain relief housing, then snap the clamp and cover.

Product family

WINSTA® MINI

[Show all products from the family](#)

Subject to changes. Please also observe the further product documentation!