

**Data sheet | Item number: 880-834/999-940**

4-conductor through terminal block; 4 mm<sup>2</sup>; with test port; suitable for Ex i applications; center marking; for DIN-rail 35 x 15 and 35 x 7.5; CAGE CLAMP®; 4,00 mm<sup>2</sup>; blue

[www.wago.com/880-834/999-940](http://www.wago.com/880-834/999-940)

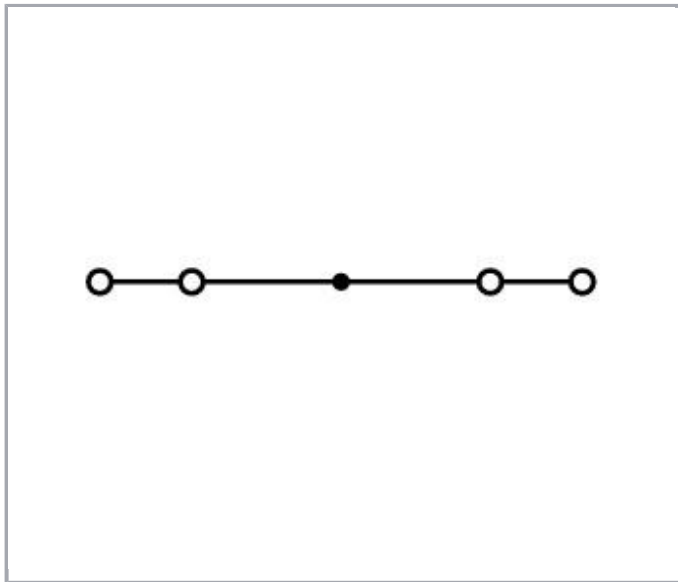
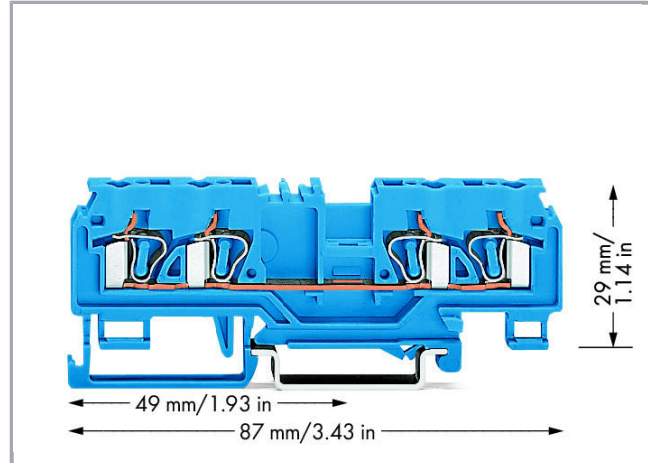
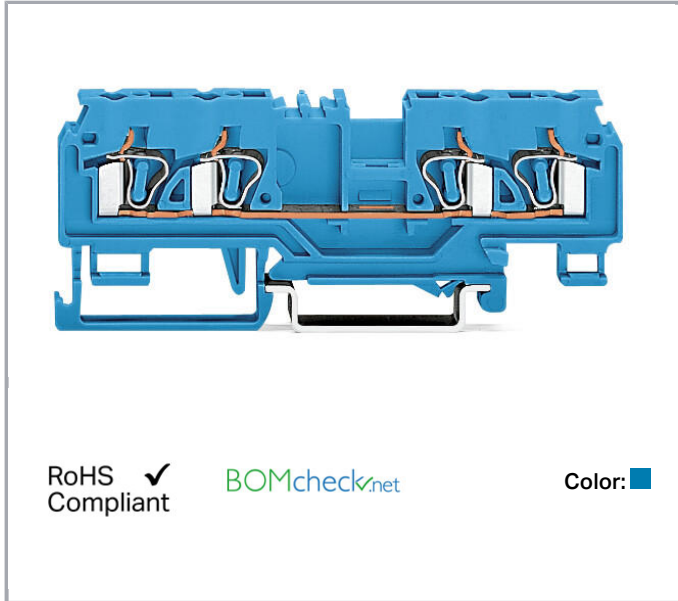

**Data**

**Electrical data**

Subject to changes. Please also observe the further product documentation!

WAGO Kontakttechnik GmbH & Co. KG  
Hansastr. 27  
32423 Minden  
Phone: +49571 887-0 | Fax: +49571 887-169  
Email: [info.de@wago.com](mailto:info.de@wago.com) | Web: [www.wago.com](http://www.wago.com)

Do you have any questions about our products?  
We are always happy to take your call at +49 (571) 887-44222.



## Ratings per IEC/EN 60664-1

|                                 |   |
|---------------------------------|---|
| Ratings per                     | IEC/EN 60947-7-1  |
| Rated voltage (III / 3)         | 800 V   |
| Rated impulse voltage (III / 3) | 8 kV  |
| Rated current                   | 20 A  |
| Legend (ratings)                | (III / 3) ≙ Overvoltage category III / Pollution degree 3 |

## Connection data

|                                   |  |
|-----------------------------------|--|
| Connection technology             | CAGE CLAMP®                                |
| Actuation type                    | Operating tool                             |
| Connectable conductor materials   | Copper                                     |
| Solid conductor                   | 0,08 ... 4 mm <sup>2</sup> / 28 ... 12 AWG |
| Fine-stranded conductor           | 0,08 ... 4 mm <sup>2</sup> / 28 ... 12 AWG |
| Strip length                      | 8 ... 9 mm / 0.31 ... 0.35 inch            |
| Total number of connection points | 4  |
| Total number of potentials        | 1  |
| Number of levels                  | 1  |
| Type of wiring                    | Front-entry wiring                         |

## Geometrical Data

|                                       |                    |
|---------------------------------------|--------------------|
| Width                                 | 5 mm / 0.197 inch  |
| Height from upper-edge of DIN-35 rail | 29 mm / 1.142 inch |
| Depth                                 | 87 mm / 3.425 inch |

## Mechanical data

|                  |                 |
|------------------|-----------------|
| Design           | horizontal type |
| Type of mounting | DIN-35 rail     |
| Marking level    | Center marking  |

## Material Data

|                     |                      |
|---------------------|----------------------|
| Color               | blue                 |
| Insulating material | Polyamide 66 (PA 66) |
| Fire load           | 0.175 MJ             |
| Weight              | 12 g                 |



Subject to changes. Please also observe the further product documentation!

## Commercial data



|                    |               |
|--------------------|---------------|
| Packaging type     | BOX           |
| Country of origin  | PL            |
| GTIN               | 4044918560863 |
| Customs Tariff No. | 85369010000   |

## Approvals / Certificates

### Country specific Approvals

| Logo   | Approval                        | Additional Approval Text | Certificate name |
|--|---------------------------------|--------------------------|------------------|
|  | CCA<br>DEKRA Certification B.V. | EN 60947                 | 2174152.01       |
|  | CCA<br>DEKRA Certification B.V. | EN 60947                 | NTR-NL<br>7339   |

### Ship Approvals

| Logo   | Approval   | Additional Approval Text | Certificate name         |
|--|--|--------------------------|--------------------------|
|  | ABS<br>American Bureau of Shipping               | EN 60947                 | 20-<br>HG1941090-<br>PDA |
|  | DNV GL<br>Det Norske Veritas, Germanischer Lloyd | -                        | TAE00001V2               |

### UL-Approvals

| Logo   | Approval                             | Additional Approval Text | Certificate name    |
|--|--------------------------------------|--------------------------|---------------------|
|  | UL<br>Underwriters Laboratories Inc. | UL 1059                  | 20170731-<br>E45172 |

## Counterpart

Subject to changes. Please also observe the further product documentation!

WAGO Kontakttechnik GmbH & Co. KG  
 Hansastr. 27  
 32423 Minden  
 Phone: +49571 887-0 | Fax: +49571 887-169  
 Email: [info.de@wago.com](mailto:info.de@wago.com) | Web: [www.wago.com](http://www.wago.com)











Do you have any questions about our products?  
 We are always happy to take your call at +49 (571) 887-44222.

## Compatible products







### Marking accessories

|   |  |  |
|---|--|--|
|    | <b>Item no.: 2009-115</b><br>WMB-Inline; for Smart Printer; 1500 pieces on roll; stretchable 5 - 5.2 mm; plain; snap-on type; white              | <a href="http://www.wago.com/2009-115">www.wago.com/2009-115</a>                 |
|   | <b>Item no.: 2009-115/000-002</b><br>WMB-Inline; for Smart Printer; 1500 pieces on roll; stretchable 5 - 5.2 mm; plain; snap-on type; yellow     | <a href="http://www.wago.com/2009-115/000-002">www.wago.com/2009-115/000-002</a> |
|    | <b>Item no.: 2009-115/000-006</b><br>WMB-Inline; for Smart Printer; 1500 pieces on roll; stretchable 5 - 5.2 mm; plain; snap-on type; white      | <a href="http://www.wago.com/2009-115/000-006">www.wago.com/2009-115/000-006</a> |
|   | <b>Item no.: 2009-115/000-007</b><br>WMB-Inline; for Smart Printer; 1500 pieces on roll; stretchable 5 - 5.2 mm; plain; snap-on type; gray       | <a href="http://www.wago.com/2009-115/000-007">www.wago.com/2009-115/000-007</a> |
|   | <b>Item no.: 2009-115/000-012</b><br>WMB-Inline; for Smart Printer; 1500 pieces on roll; stretchable 5 - 5.2 mm; plain; snap-on type; white      | <a href="http://www.wago.com/2009-115/000-012">www.wago.com/2009-115/000-012</a> |
|  | <b>Item no.: 2009-115/000-017</b><br>WMB-Inline; for Smart Printer; 1500 pieces on roll; stretchable 5 - 5.2 mm; plain; snap-on type; white      | <a href="http://www.wago.com/2009-115/000-017">www.wago.com/2009-115/000-017</a> |
|  | <b>Item no.: 2009-115/000-023</b><br>WMB-Inline; for Smart Printer; 1500 pieces on roll; stretchable 5 - 5.2 mm; plain; snap-on type; green      | <a href="http://www.wago.com/2009-115/000-023">www.wago.com/2009-115/000-023</a> |
|   | <b>Item no.: 2009-115/000-024</b><br>WMB-Inline; for Smart Printer; 1500 pieces on roll; stretchable 5 - 5.2 mm; plain; snap-on type; white      | <a href="http://www.wago.com/2009-115/000-024">www.wago.com/2009-115/000-024</a> |
|   | <b>Item no.: 2009-145</b><br>Mini-WSB Inline; for Smart Printer; 1700 pieces on roll; stretchable 5 - 5.2 mm; plain; snap-on type; white         | <a href="http://www.wago.com/2009-145">www.wago.com/2009-145</a>                 |
|   | <b>Item no.: 2009-145/000-002</b><br>Mini-WSB Inline; for Smart Printer; 1700 pieces on roll; stretchable 5 - 5.2 mm; plain; snap-on type; white | <a href="http://www.wago.com/2009-145/000-002">www.wago.com/2009-145/000-002</a> |













Subject to changes. Please also observe the further product documentation!

|  |   |   |
|--|---|---|
|    | <p><b>Item no.:</b> 2009-145/000-005<br/>Mini-WSB Inline; for Smart Printer; 1700 pieces on roll; stretchable 5 - 5.2 mm; plain; snap-on type; red</p>    | <p><a href="http://www.wago.com/2009-145/000-005">www.wago.com/2009-145/000-005</a></p> |
|    | <p><b>Item no.:</b> 2009-145/000-006<br/>Mini-WSB Inline; for Smart Printer; 1700 pieces on roll; stretchable 5 - 5.2 mm; plain; snap-on type; blue</p>   | <p><a href="http://www.wago.com/2009-145/000-006">www.wago.com/2009-145/000-006</a></p> |
|  | <p><b>Item no.:</b> 2009-145/000-007<br/>Mini-WSB Inline; for Smart Printer; 1700 pieces on roll; stretchable 5 - 5.2 mm; plain; snap-on type; white</p>  | <p><a href="http://www.wago.com/2009-145/000-007">www.wago.com/2009-145/000-007</a></p> |
|  | <p><b>Item no.:</b> 2009-145/000-012<br/>Mini-WSB Inline; for Smart Printer; 1700 pieces on roll; stretchable 5 - 5.2 mm; plain; snap-on type; orange</p> | <p><a href="http://www.wago.com/2009-145/000-012">www.wago.com/2009-145/000-012</a></p> |
|    | <p><b>Item no.:</b> 2009-145/000-023<br/>Mini-WSB Inline; for Smart Printer; 1700 pieces on roll; stretchable 5 - 5.2 mm; plain; snap-on type; green</p>  | <p><a href="http://www.wago.com/2009-145/000-023">www.wago.com/2009-145/000-023</a></p> |
|    | <p><b>Item no.:</b> 2009-145/000-024<br/>Mini-WSB Inline; for Smart Printer; 1700 pieces on roll; stretchable 5 - 5.2 mm; plain; snap-on type; violet</p> | <p><a href="http://www.wago.com/2009-145/000-024">www.wago.com/2009-145/000-024</a></p> |
|    | <p><b>Item no.:</b> 248-501<br/>Miniature WSB Quick marking system; plain; Marker width 5 mm; 10 strips with 10 markers per card</p>                      | <p><a href="http://www.wago.com/248-501">www.wago.com/248-501</a></p>                   |
|  | <p><b>Item no.:</b> 248-501/000-002<br/>Mini-WSB marking card; as card; not stretchable; plain; snap-on type; yellow</p>                                  | <p><a href="http://www.wago.com/248-501/000-002">www.wago.com/248-501/000-002</a></p>   |
|  | <p><b>Item no.:</b> 248-501/000-005<br/>Mini-WSB marking card; as card; not stretchable; plain; snap-on type; red</p>                                     | <p><a href="http://www.wago.com/248-501/000-005">www.wago.com/248-501/000-005</a></p>   |
|  | <p><b>Item no.:</b> 248-501/000-006<br/>Mini-WSB marking card; as card; not stretchable; plain; snap-on type; blue</p>                                    | <p><a href="http://www.wago.com/248-501/000-006">www.wago.com/248-501/000-006</a></p>   |
|  | <p><b>Item no.:</b> 248-501/000-007<br/>Mini-WSB marking card; as card; not stretchable; plain; snap-on type; gray</p>                                    | <p><a href="http://www.wago.com/248-501/000-007">www.wago.com/248-501/000-007</a></p>   |
|  | <p><b>Item no.:</b> 248-501/000-012<br/>Mini-WSB marking card; as card; not stretchable; plain; snap-on type; orange</p>                                  | <p><a href="http://www.wago.com/248-501/000-012">www.wago.com/248-501/000-012</a></p>   |
|  | <p><b>Item no.:</b> 248-501/000-017<br/>Mini-WSB marking card; as card; not stretchable; plain; snap-on type; light green</p>                             | <p><a href="http://www.wago.com/248-501/000-017">www.wago.com/248-501/000-017</a></p>   |
|  | <p><b>Item no.:</b> 248-501/000-023<br/>Mini-WSB marking card; as card; not stretchable; plain; snap-on type; green</p>                                   | <p><a href="http://www.wago.com/248-501/000-023">www.wago.com/248-501/000-023</a></p>   |











Subject to changes. Please also observe the further product documentation!

|  |   |  |
|--|---|--|
|    | <p><b>Item no.: 248-501/000-024</b><br/>Mini-WSB marking card; as card; not stretchable; plain; snap-on type; violet</p>  | <a href="http://www.wago.com/248-501/000-024">www.wago.com/248-501/000-024</a>   |
|  | <p><b>Item no.: 249-105</b><br/>Group marker carrier; gray</p>  | <a href="http://www.wago.com/249-105">www.wago.com/249-105</a>                   |
|  | <p><b>Item no.: 793-501</b><br/>WMB marking card; as card; not stretchable; plain; snap-on type; white</p>  | <a href="http://www.wago.com/793-501">www.wago.com/793-501</a>                   |
|  | <p><b>Item no.: 793-501/000-002</b><br/>WMB marking card; as card; not stretchable; plain; snap-on type; yellow</p>   | <a href="http://www.wago.com/793-501/000-002">www.wago.com/793-501/000-002</a>   |
|    | <p><b>Item no.: 793-501/000-005</b><br/>WMB marking card; as card; not stretchable; plain; snap-on type; red</p>  | <a href="http://www.wago.com/793-501/000-005">www.wago.com/793-501/000-005</a>   |
|    | <p><b>Item no.: 793-501/000-006</b><br/>WMB marking card; as card; not stretchable; plain; snap-on type; blue</p>   | <a href="http://www.wago.com/793-501/000-006">www.wago.com/793-501/000-006</a>   |
|    | <p><b>Item no.: 793-501/000-007</b><br/>WMB marking card; as card; not stretchable; plain; snap-on type; gray</p>   | <a href="http://www.wago.com/793-501/000-007">www.wago.com/793-501/000-007</a>   |
|  | <p><b>Item no.: 793-501/000-012</b><br/>WMB marking card; as card; not stretchable; plain; snap-on type; orange</p>   | <a href="http://www.wago.com/793-501/000-012">www.wago.com/793-501/000-012</a>   |
|  | <p><b>Item no.: 793-501/000-017</b><br/>WMB marking card; as card; not stretchable; plain; snap-on type; light green</p>  | <a href="http://www.wago.com/793-501/000-017">www.wago.com/793-501/000-017</a>   |
|  | <p><b>Item no.: 793-501/000-023</b><br/>WMB marking card; as card; not stretchable; plain; snap-on type; green</p>  | <a href="http://www.wago.com/793-501/000-023">www.wago.com/793-501/000-023</a>   |
|  | <p><b>Item no.: 793-501/000-024</b><br/>WMB marking card; as card; not stretchable; plain; snap-on type; violet</p>   | <a href="http://www.wago.com/793-501/000-024">www.wago.com/793-501/000-024</a>   |
|  | <p><b>Item no.: 793-5501</b><br/>WMB marking card; as card; for terminal block width 5 - 17.5 mm; stretchable 5 - 5.2 mm; plain; snap-on type; white</p>          | <a href="http://www.wago.com/793-5501">www.wago.com/793-5501</a>                 |
|  | <p><b>Item no.: 793-5501/000-002</b><br/>WMB marking card; as card; for terminal block width 5 - 17.5 mm; stretchable 5 - 5.2 mm; plain; snap-on type; yellow</p> | <a href="http://www.wago.com/793-5501/000-002">www.wago.com/793-5501/000-002</a> |
|  | <p><b>Item no.: 793-5501/000-005</b><br/>WMB marking card; as card; for terminal block width 5 - 17.5 mm; stretchable 5 - 5.2 mm; plain; snap-on type; red</p>    | <a href="http://www.wago.com/793-5501/000-005">www.wago.com/793-5501/000-005</a> |

Subject to changes. Please also observe the further product documentation!

|  |  |   |
|--|--|---|
|  | <p><b>Item no.: 793-5501/000-006</b><br/>WMB marking card; as card; for terminal block width 5 - 17.5 mm; stretchable 5 - 5.2 mm; plain; snap-on type; blue</p>        | <p><a href="http://www.wago.com/793-5501/000-006">www.wago.com/793-5501/000-006</a></p> |
|  | <p><b>Item no.: 793-5501/000-007</b><br/>WMB marking card; as card; for terminal block width 5 - 17.5 mm; stretchable 5 - 5.2 mm; plain; snap-on type; gray</p>        | <p><a href="http://www.wago.com/793-5501/000-007">www.wago.com/793-5501/000-007</a></p> |
|    | <p><b>Item no.: 793-5501/000-012</b><br/>WMB marking card; as card; for terminal block width 5 - 17.5 mm; stretchable 5 - 5.2 mm; plain; snap-on type; orange</p>      | <p><a href="http://www.wago.com/793-5501/000-012">www.wago.com/793-5501/000-012</a></p> |
|    | <p><b>Item no.: 793-5501/000-017</b><br/>WMB marking card; as card; for terminal block width 5 - 17.5 mm; stretchable 5 - 5.2 mm; plain; snap-on type; green</p>       | <p><a href="http://www.wago.com/793-5501/000-017">www.wago.com/793-5501/000-017</a></p> |
|    | <p><b>Item no.: 793-5501/000-023</b><br/>WMB marking card; as card; for terminal block width 5 - 17.5 mm; stretchable 5 - 5.2 mm; plain; snap-on type; light green</p> | <p><a href="http://www.wago.com/793-5501/000-023">www.wago.com/793-5501/000-023</a></p> |
|    | <p><b>Item no.: 793-5501/000-024</b><br/>WMB marking card; as card; for terminal block width 5 - 17.5 mm; stretchable 5 - 5.2 mm; plain; snap-on type; violet</p>      | <p><a href="http://www.wago.com/793-5501/000-024">www.wago.com/793-5501/000-024</a></p> |
| <b>Insulation stop</b>   |  |   |
|   | <p><b>Item no.: 280-470</b><br/>Insulation stop; 0.08 - 0.2 mm<sup>2</sup> "s" (0.14 mm<sup>2</sup> "f-st"); 5 pieces/strip; white</p>                                 | <p><a href="http://www.wago.com/280-470">www.wago.com/280-470</a></p>                   |
|  | <p><b>Item no.: 280-471</b><br/>Insulation stop; 0.25 - 0.5 mm<sup>2</sup>; 5 pieces/strip; light gray</p>   | <p><a href="http://www.wago.com/280-471">www.wago.com/280-471</a></p>                   |
|  | <p><b>Item no.: 280-472</b><br/>Insulation stop; 0.75 - 1 mm<sup>2</sup>; 5 pieces/strip</p>   | <p><a href="http://www.wago.com/280-472">www.wago.com/280-472</a></p>                   |
| <b>Test Accessories</b>  |  |   |
|  | <p><b>Item no.: 209-170</b><br/>Test plug adapter; 8.3 mm wide; for 4 mm Ø test plugs; suitable for 1.5 mm<sup>2</sup> - 10 mm<sup>2</sup> tbs; gray</p>               | <p><a href="http://www.wago.com/209-170">www.wago.com/209-170</a></p>                   |
|  | <p><b>Item no.: 210-136</b><br/>Test plug; 2 mm Ø; with 500 mm cable; red</p>  | <p><a href="http://www.wago.com/210-136">www.wago.com/210-136</a></p>                   |
|  | <p><b>Item no.: 210-137</b><br/>Test plug; 2.3 mm Ø; with 500 mm cable; yellow</p>   | <p><a href="http://www.wago.com/210-137">www.wago.com/210-137</a></p>                   |
|  | <p><b>Item no.: 249-106</b><br/>B-type test plug module; modular; 1,50 mm<sup>2</sup>; gray</p>  | <p><a href="http://www.wago.com/249-106">www.wago.com/249-106</a></p>                   |
|  | <p><b>Item no.: 249-107</b><br/>B-type spacer module; modular; e.g., for bridging commoned terminal blocks; gray</p>   | <p><a href="http://www.wago.com/249-107">www.wago.com/249-107</a></p>                   |
|  | <p><b>Item no.: 280-404</b><br/>Test plug adapter; 5 mm wide; for test plug 210-137 (2.3 mm Ø); suitable for 1.5 mm<sup>2</sup> - 4 mm<sup>2</sup> tbs; gray</p>       | <p><a href="http://www.wago.com/280-404">www.wago.com/280-404</a></p>                   |

Subject to changes. Please also observe the further product documentation!

|  |  |  |
|--|--|--|
|    | <p><b>Item no.: 280-418</b><br/>                     Test plug module; modular; suitable for all WAGO 280 and 780 Series rail-mounted terminal blocks with jumper slots in the current bar; gray</p> | <a href="http://www.wago.com/280-418">www.wago.com/280-418</a> |
|    | <p><b>Item no.: 280-419</b><br/>                     Spacer module; modular; bridging commoned terminal blocks; gray</p>   | <a href="http://www.wago.com/280-419">www.wago.com/280-419</a> |
| <b>Carrier rail</b>  |  |  |
|  | <p><b>Item no.: 210-112</b><br/>                     Steel carrier rail; 35 x 7.5 mm; 1 mm thick; 2 m long; slotted; according to EN 60715; "Hole width 25 mm</p>                                    | <a href="http://www.wago.com/210-112">www.wago.com/210-112</a> |
|  | <p><b>Item no.: 210-113</b><br/>                     Steel carrier rail; 35 x 7.5 mm; 1 mm thick; 2 m long; unslotted; according to EN 60715</p>   | <a href="http://www.wago.com/210-113">www.wago.com/210-113</a> |
|  | <p><b>Item no.: 210-114</b><br/>                     Steel carrier rail; 35 x 15 mm; 1.5 mm thick; 2 m long; unslotted; similar to EN 60715</p>  | <a href="http://www.wago.com/210-114">www.wago.com/210-114</a> |
|    | <p><b>Item no.: 210-115</b><br/>                     Steel carrier rail; 35 x 7.5 mm; 1 mm thick; 2 m long; slotted; according to EN 60715; "Hole width 18 mm</p>                                    | <a href="http://www.wago.com/210-115">www.wago.com/210-115</a> |
|  | <p><b>Item no.: 210-118</b><br/>                     Steel carrier rail; 35 x 15 mm; 2.3 mm thick; 2 m long; unslotted; according to EN 60715</p>  | <a href="http://www.wago.com/210-118">www.wago.com/210-118</a> |
|    | <p><b>Item no.: 210-196</b><br/>                     Aluminum carrier rail; 35 x 8.2 mm; 1.6 mm thick; 2 m long; unslotted; similar to EN 60715; silver-colored</p>                                  | <a href="http://www.wago.com/210-196">www.wago.com/210-196</a> |
|  | <p><b>Item no.: 210-197</b><br/>                     Steel carrier rail; 35 x 15 mm; 1.5 mm thick; 2 m long; slotted; similar to EN 60715</p>  | <a href="http://www.wago.com/210-197">www.wago.com/210-197</a> |
|  | <p><b>Item no.: 210-198</b><br/>                     Copper carrier rail; 35 x 15 mm; 2.3 mm thick; 2 m long; unslotted; according to EN 60715; copper-colored</p>                                   | <a href="http://www.wago.com/210-198">www.wago.com/210-198</a> |
|  | <p><b>Item no.: 210-504</b><br/>                     Steel carrier rail; 35 x 7.5 mm; 1 mm thick; 2 m long; slotted; galvanized; according to EN 60715</p>   | <a href="http://www.wago.com/210-504">www.wago.com/210-504</a> |
|  | <p><b>Item no.: 210-505</b><br/>                     Steel carrier rail; 35 x 7.5 mm; 1 mm thick; 2 m long; unslotted; galvanized; according to EN 60715</p>   | <a href="http://www.wago.com/210-505">www.wago.com/210-505</a> |
|  | <p><b>Item no.: 210-506</b><br/>                     Steel carrier rail; 35 x 15 mm; 1.5 mm thick; 2 m long; unslotted; galvanized; similar to EN 60715</p>  | <a href="http://www.wago.com/210-506">www.wago.com/210-506</a> |
|  | <p><b>Item no.: 210-508</b><br/>                     Steel carrier rail; 35 x 15 mm; 1.5 mm thick; 2 m long; slotted; galvanized; similar to EN 60715</p>  | <a href="http://www.wago.com/210-508">www.wago.com/210-508</a> |
| <b>Protective Warning Marker</b>   |  |  |
|  | <p><b>Item no.: 280-415</b><br/>                     Protective warning marker; with high-voltage symbol, black; for 5 terminal blocks; yellow</p>   | <a href="http://www.wago.com/280-415">www.wago.com/280-415</a> |
| <b>General accessories</b>   |  |  |
|  | <p><b>Item no.: 281-407</b><br/>                     Test plug; 6 mm wide; Nominal current 24 A; for 0.08 mm<sup>2</sup> - 2.5 mm<sup>2</sup>; 2,50 mm<sup>2</sup>; gray</p>                         | <a href="http://www.wago.com/281-407">www.wago.com/281-407</a> |

Subject to changes. Please also observe the further product documentation!



## ferrule



**Item no.: 216-206**  
Ferrule; Sleeve for 2.5 mm<sup>2</sup> / AWG 14; insulated; electro-tin plated; blue

[www.wago.com/216-206](http://www.wago.com/216-206)

## assembling

**Item no.: 209-106**  
Mounting carrier; for isolated mounting on DIN 35 rails; gray

[www.wago.com/209-106](http://www.wago.com/209-106)

**Item no.: 709-153**  
Cover; Type 1; suitable for cover carrier, type 1; 1 m long; transparent

[www.wago.com/709-153](http://www.wago.com/709-153)

## Jumper



**Item no.: 210-103**  
Wire commoning chain; insulated; 50 connections; black

[www.wago.com/210-103](http://www.wago.com/210-103)

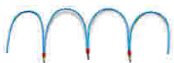

**Item no.: 210-123**  
Wire commoning chain; insulated; 50 connections

[www.wago.com/210-123](http://www.wago.com/210-123)

**Item no.: 249-123**  
Push-in type wire jumper; insulated; wire length 180 mm; Conductor cross section 0.75 mm<sup>2</sup>

[www.wago.com/249-123](http://www.wago.com/249-123)

**Item no.: 249-125**  
Push-in type wire jumper; insulated; wire length 60 mm; Conductor cross section 0.75 mm<sup>2</sup>

[www.wago.com/249-125](http://www.wago.com/249-125)



**Item no.: 249-126**  
Push-in type wire jumper; insulated; wire length 110 mm; Conductor cross section 0.75 mm<sup>2</sup>

[www.wago.com/249-126](http://www.wago.com/249-126)

**Item no.: 249-127**  
Push-in type wire jumper; insulated; wire length 250 mm; Conductor cross section 0.75 mm<sup>2</sup>

[www.wago.com/249-127](http://www.wago.com/249-127)



**Item no.: 280-402**  
Adjacent jumper; insulated; IN = IN terminal block; gray

[www.wago.com/280-402](http://www.wago.com/280-402)



**Item no.: 280-409**  
Alternate jumper; insulated; IN = IN terminal block; gray

[www.wago.com/280-409](http://www.wago.com/280-409)



**Item no.: 280-422**  
Adjacent jumper; insulated; IN = IN terminal block; yellow-green

[www.wago.com/280-422](http://www.wago.com/280-422)



**Item no.: 709-110**  
Wire commoning chain; insulated; 4 connections; 3 x 110 mm; black

[www.wago.com/709-110](http://www.wago.com/709-110)



**Item no.: 709-111**  
Wire commoning chain; insulated; 3 connections; 2 x 120 mm; black

[www.wago.com/709-111](http://www.wago.com/709-111)

**Item no.: 709-112**  
Wire commoning chain; insulated; 3 connections; 2 x 170 mm; black

[www.wago.com/709-112](http://www.wago.com/709-112)

**Item no.: 780-452**  
Staggered jumper; insulated; from 1 to 2; Spacing: 5 mm; suitable for 2-conductor female plugs; gray





[www.wago.com/780-452](http://www.wago.com/780-452)

**Item no.: 780-453**  
Staggered jumper; insulated; from 1 to 3; Spacing: 5 mm; suitable for 2-conductor female plugs;

[www.wago.com/780-453](http://www.wago.com/780-453)

Subject to changes. Please also observe the further product documentation!

gray

|  |  |  |
|--|--|--|
|  | <b>Item no.: 780-454</b><br>Staggered jumper; insulated; from 1 to 4; Spacing: 5 mm; suitable for 2-conductor female plugs; gray | <a href="http://www.wago.com/780-454">www.wago.com/780-454</a> |
|  | <b>Item no.: 780-455</b><br>Staggered jumper; insulated; from 1 to 5; Spacing: 5 mm; suitable for 2-conductor female plugs; gray | <a href="http://www.wago.com/780-455">www.wago.com/780-455</a> |
|  | <b>Item no.: 780-456</b><br>Staggered jumper; insulated; from 1 to 6; Spacing: 5 mm; suitable for 2-conductor female plugs; gray | <a href="http://www.wago.com/780-456">www.wago.com/780-456</a> |
|  | <b>Item no.: 780-457</b><br>Staggered jumper; insulated; from 1 to 7; Spacing: 5 mm; suitable for 2-conductor female plugs; gray | <a href="http://www.wago.com/780-457">www.wago.com/780-457</a> |
|  | <b>Item no.: 780-458</b><br>Staggered jumper; insulated; from 1 to 8; Spacing: 5 mm; suitable for 2-conductor female plugs; gray | <a href="http://www.wago.com/780-458">www.wago.com/780-458</a> |

**End plate**

|  |  |  |
|--|--|--|
|    | <b>Item no.: 880-344</b><br>End and intermediate plate; 2.5 mm thick; gray   | <a href="http://www.wago.com/880-344">www.wago.com/880-344</a> |
|    | <b>Item no.: 880-345</b><br>Separator plate; 2 mm thick; oversized; gray     | <a href="http://www.wago.com/880-345">www.wago.com/880-345</a> |
|  | <b>Item no.: 880-346</b><br>End and intermediate plate; 2.5 mm thick; orange | <a href="http://www.wago.com/880-346">www.wago.com/880-346</a> |
|  | <b>Item no.: 880-347</b><br>Separator plate; 2 mm thick; oversized; orange   | <a href="http://www.wago.com/880-347">www.wago.com/880-347</a> |

**Downloads**

**Documentation**

**Additional Information**

|                        |             |               |          |
|------------------------|-------------|---------------|----------|
| Technical explanations | Apr 3, 2019 | pdf<br>2.1 MB | Download |
|------------------------|-------------|---------------|----------|

**CAD/CAE-Data**

**CAD data**

|                              |     |          |
|------------------------------|-----|----------|
| 2D/3D Models 880-834/999-940 | URL | Download |
|------------------------------|-----|----------|

**CAE data**

|                                   |     |          |
|-----------------------------------|-----|----------|
| EPLAN Data Portal 880-834/999-940 | URL | Download |
|-----------------------------------|-----|----------|

Subject to changes. Please also observe the further product documentation!

WAGO Kontakttechnik GmbH & Co. KG  
 Hansastr. 27  
 32423 Minden  
 Phone: +49571 887-0 | Fax: +49571 887-169  
 Email: [info.de@wago.com](mailto:info.de@wago.com) | Web: [www.wago.com](http://www.wago.com)

Do you have any questions about our products?  
 We are always happy to take your call at +49 (571) 887-44222.



WSCAD Universe 880-834/999-940

URL

Download

---

## Installation Notes

Subject to changes. Please also observe the further product documentation!

---

WAGO Kontakttechnik GmbH & Co. KG  
Hansastr. 27  
32423 Minden  
Phone: +49571 887-0 | Fax: +49571 887-169  
Email: [info.de@wago.com](mailto:info.de@wago.com) | Web: [www.wago.com](http://www.wago.com)

Do you have any questions about our products?  
We are always happy to take your call at +49 (571) 887-44222.

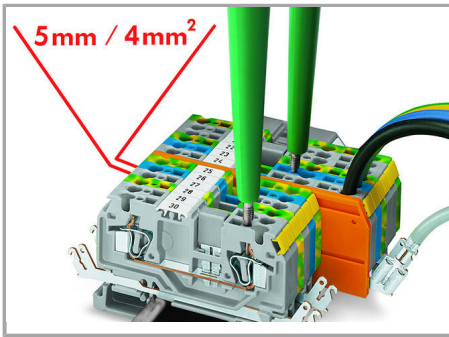

**Features:**

- 2-, 3- and 4-conductor terminal blocks, just 5 mm wide
- 
- Conductor cross section up to 4 mm<sup>2</sup> (per VDE 0281) or 12 AWG with ferrule (Item No. 216-206) 2.5 mm<sup>2</sup> rubber-insulated conductors with outer diameter up to 4.4 mm
- 
- Shield contact, solder/quick-connect contact 6.3 (2 x 2.8) mm
- 
- Test plug, red, 2 mm Ø
- 
- Test plug, yellow, 2.3 mm Ø
- 
- WMB markers
- 
- Mini-WSB markers, on both sides
- 
- Commoning with WAGO jumper systems
- 

**Conductor termination**

Subject to changes. Please also observe the further product documentation!

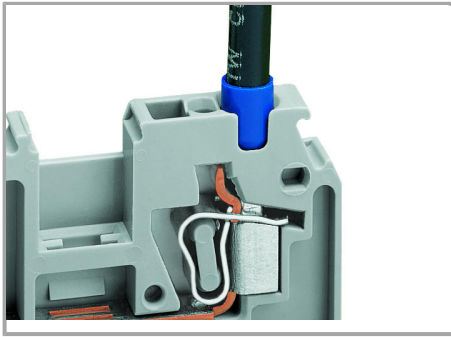

Using a 12 AWG conductor with ferrule.

Item No. 216-206

### Testing

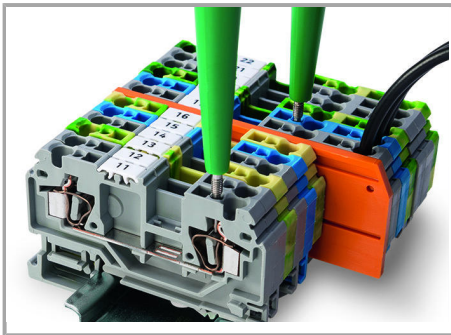

880 Series terminal blocks have an additional test slot for 2-pole voltage tester

Subject to changes. Please also observe the further product documentation!