

**Data sheet | Item number: 880-831**

4-conductor through terminal block; 4 mm<sup>2</sup>; with test port; without shield contact; center marking; for DIN-rail 35 x 15 and 35 x 7.5; CAGE CLAMP®; 4,00 mm<sup>2</sup>; gray

[www.wago.com/880-831](http://www.wago.com/880-831)

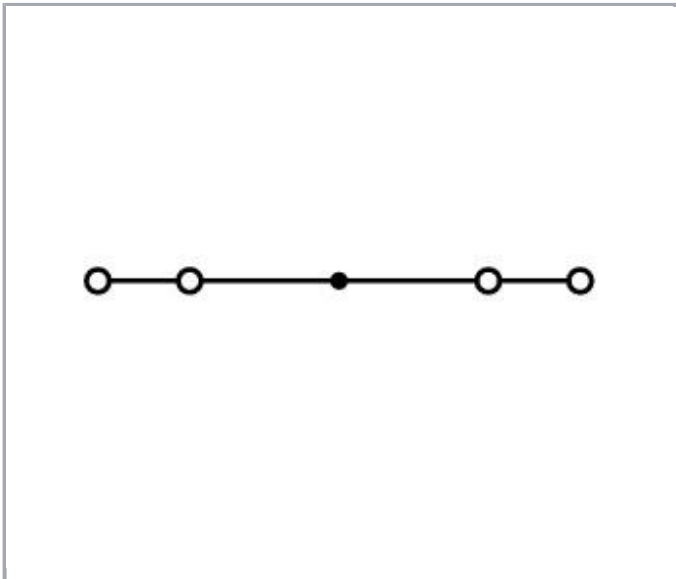
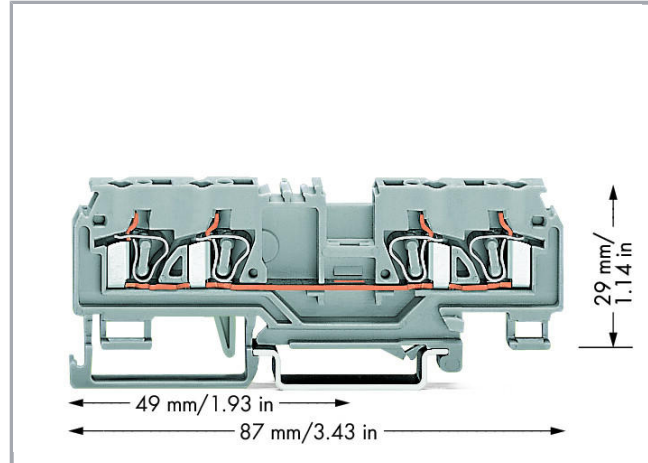
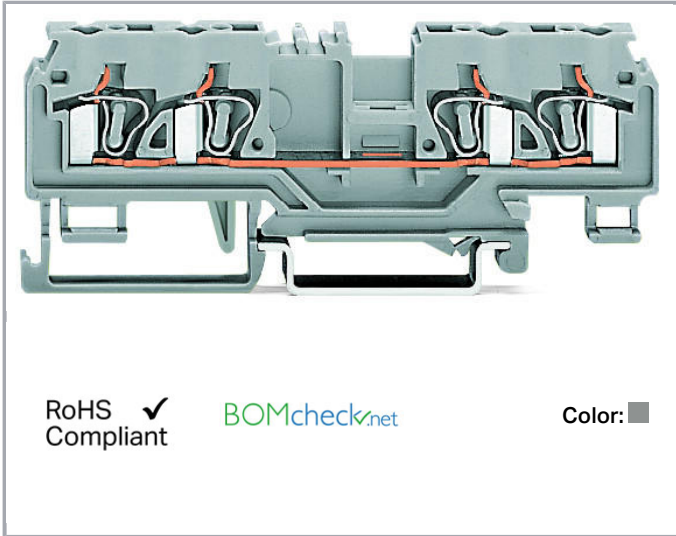

**Data**

**Electrical data**

**Ratings per IEC/EN 60664-1**

Ratings per

IEC/EN 60947-7-1

Subject to changes. Please also observe the further product documentation!

WAGO Kontakttechnik GmbH & Co. KG  
Hansastr. 27  
32423 Minden  
Phone: +49571 887-0 | Fax: +49571 887-169  
Email: [info.de@wago.com](mailto:info.de@wago.com) | Web: [www.wago.com](http://www.wago.com)

Do you have any questions about our products?  
We are always happy to take your call at +49 (571) 887-44222.



Rated voltage (III / 3)	800 V
Rated impulse voltage (III / 3)	8 kV
Rated current	20 A
Legend (ratings)	(III / 3) $\triangleq$ Overvoltage category III / Pollution degree 3

### Connection data

Connection technology	CAGE CLAMP®
Actuation type	Operating tool
Connectable conductor materials	Copper
Solid conductor	0,08 ... 4 mm <sup>2</sup> / 28 ... 12 AWG
Fine-stranded conductor	0,08 ... 4 mm <sup>2</sup> / 28 ... 12 AWG
Strip length	8 ... 9 mm / 0.31 ... 0.35 inch
Total number of connection points	4
Total number of potentials	1
Number of levels	1
Type of wiring	Front-entry wiring

### Geometrical Data

Width	5 mm / 0.197 inch
Height from upper-edge of DIN-35 rail	29 mm / 1.142 inch
Depth	87 mm / 3.425 inch

### Mechanical data

Design	horizontal type
Type of mounting	DIN-35 rail
Marking level	Center marking

### Material Data

Color	gray
Insulating material	Polyamide 66 (PA 66)
Fire load	0.176 MJ
Weight	10.8 g

### Commercial data



Product Group	1 (Rail Mounted Terminal Blocks)
Packaging type	BOX

Subject to changes. Please also observe the further product documentation!



Country of origin	PL
GTIN	4044918560757
Customs Tariff No.	85369010000

## Approvals / Certificates

### Country specific Approvals

Logo	Approval	Additional Approval Text	Certificate name
	<b>CCA</b> DEKRA Certification B.V.	EN 60947	NTR-NL 7339
	<b>CCA</b> DEKRA Certification B.V.	EN 60947	2174152.01

### Ship Approvals

Logo	Approval	Additional Approval Text	Certificate name
	<b>ABS</b> American Bureau of Shipping	EN 60947	20- HG1941090- PDA
	<b>DNV GL</b> Det Norske Veritas, Germanischer Lloyd	-	TAE00001V2

### UL-Approvals

Logo	Approval	Additional Approval Text	Certificate name
	<b>UL</b> Underwriters Laboratories Inc.	UL 1059	20170731- E45172

## Counterpart

Subject to changes. Please also observe the further product documentation!

WAGO Kontakttechnik GmbH & Co. KG  
 Hansastr. 27  
 32423 Minden  
 Phone: +49571 887-0 | Fax: +49571 887-169  
 Email: [info.de@wago.com](mailto:info.de@wago.com) | Web: [www.wago.com](http://www.wago.com)

Do you have any questions about our products?  
 We are always happy to take your call at +49 (571) 887-44222.

## Compatible products

### General accessories



**Item no.: 281-407**

Test plug; 6 mm wide; Nominal current 24 A; for 0.08 mm<sup>2</sup> - 2.5 mm<sup>2</sup>; 2,50 mm<sup>2</sup>; gray

[www.wago.com/281-407](http://www.wago.com/281-407)

### Jumper



**Item no.: 210-103**

Wire commoning chain; insulated; 50 connections; black

[www.wago.com/210-103](http://www.wago.com/210-103)

**Item no.: 210-123**

Wire commoning chain; insulated; 50 connections

[www.wago.com/210-123](http://www.wago.com/210-123)



**Item no.: 249-123**

Push-in type wire jumper; insulated; wire length 180 mm; Conductor cross section 0.75 mm<sup>2</sup>

[www.wago.com/249-123](http://www.wago.com/249-123)

**Item no.: 249-125**

Push-in type wire jumper; insulated; wire length 60 mm; Conductor cross section 0.75 mm<sup>2</sup>

[www.wago.com/249-125](http://www.wago.com/249-125)

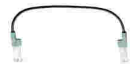

**Item no.: 249-126**

Push-in type wire jumper; insulated; wire length 110 mm; Conductor cross section 0.75 mm<sup>2</sup>

[www.wago.com/249-126](http://www.wago.com/249-126)



**Item no.: 249-127**

Push-in type wire jumper; insulated; wire length 250 mm; Conductor cross section 0.75 mm<sup>2</sup>

[www.wago.com/249-127](http://www.wago.com/249-127)



**Item no.: 280-402**

Adjacent jumper; insulated; IN = IN terminal block; gray

[www.wago.com/280-402](http://www.wago.com/280-402)



**Item no.: 280-409**

Alternate jumper; insulated; IN = IN terminal block; gray

[www.wago.com/280-409](http://www.wago.com/280-409)



**Item no.: 280-422**

Adjacent jumper; insulated; IN = IN terminal block; yellow-green

[www.wago.com/280-422](http://www.wago.com/280-422)



**Item no.: 284-414**

Step-down jumper; insulated; from 10/6 mm<sup>2</sup> to 4/2.5/1.5 mm<sup>2</sup>; Nominal current 15 A; gray

[www.wago.com/284-414](http://www.wago.com/284-414)



**Item no.: 709-110**

Wire commoning chain; insulated; 4 connections; 3 x 110 mm; black

[www.wago.com/709-110](http://www.wago.com/709-110)

**Item no.: 709-111**

Subject to changes. Please also observe the further product documentation!

WAGO Kontakttechnik GmbH & Co. KG

Hansastr. 27













32423 Minden

Phone: +49571 887-0 | Fax: +49571 887-169









Email: [info.de@wago.com](mailto:info.de@wago.com) | Web: [www.wago.com](http://www.wago.com)

Do you have any questions about our products?

We are always happy to take your call at +49 (571) 887-44222.

	Wire commoning chain; insulated; 3 connections; 2 x 120 mm; black	<a href="http://www.wago.com/709-111">www.wago.com/709-111</a>
	<b>Item no.: 709-112</b> Wire commoning chain; insulated; 3 connections; 2 x 170 mm; black	<a href="http://www.wago.com/709-112">www.wago.com/709-112</a>
	<b>Item no.: 780-452</b> Staggered jumper; insulated; from 1 to 2; Spacing: 5 mm; suitable for 2-conductor female plugs; gray	<a href="http://www.wago.com/780-452">www.wago.com/780-452</a>
	<b>Item no.: 780-453</b> Staggered jumper; insulated; from 1 to 3; Spacing: 5 mm; suitable for 2-conductor female plugs; gray	<a href="http://www.wago.com/780-453">www.wago.com/780-453</a>
	<b>Item no.: 780-454</b> Staggered jumper; insulated; from 1 to 4; Spacing: 5 mm; suitable for 2-conductor female plugs; gray	<a href="http://www.wago.com/780-454">www.wago.com/780-454</a>
	<b>Item no.: 780-455</b> Staggered jumper; insulated; from 1 to 5; Spacing: 5 mm; suitable for 2-conductor female plugs; gray	<a href="http://www.wago.com/780-455">www.wago.com/780-455</a>
	<b>Item no.: 780-456</b> Staggered jumper; insulated; from 1 to 6; Spacing: 5 mm; suitable for 2-conductor female plugs; gray	<a href="http://www.wago.com/780-456">www.wago.com/780-456</a>
	<b>Item no.: 780-457</b> Staggered jumper; insulated; from 1 to 7; Spacing: 5 mm; suitable for 2-conductor female plugs; gray	<a href="http://www.wago.com/780-457">www.wago.com/780-457</a>
	<b>Item no.: 780-458</b> Staggered jumper; insulated; from 1 to 8; Spacing: 5 mm; suitable for 2-conductor female plugs; gray	<a href="http://www.wago.com/780-458">www.wago.com/780-458</a>
<b>Protective Warning Marker</b>		
	<b>Item no.: 280-415</b> Protective warning marker; with high-voltage symbol, black; for 5 terminal blocks; yellow	<a href="http://www.wago.com/280-415">www.wago.com/280-415</a>
<b>ferrule</b>		
	<b>Item no.: 216-106</b> Ferrule; Sleeve for 2.5 mm <sup>2</sup> / AWG 14; uninsulated; electro-tin plated	<a href="http://www.wago.com/216-106">www.wago.com/216-106</a>
	<b>Item no.: 216-107</b> Ferrule; Sleeve for 4 mm <sup>2</sup> / AWG 12; uninsulated; electro-tin plated	<a href="http://www.wago.com/216-107">www.wago.com/216-107</a>
	<b>Item no.: 216-108</b> Ferrule; Sleeve for 6 mm <sup>2</sup> / AWG 10; uninsulated; electro-tin plated	<a href="http://www.wago.com/216-108">www.wago.com/216-108</a>
	<b>Item no.: 216-109</b> Ferrule; Sleeve for 10 mm <sup>2</sup> / AWG 8; uninsulated; electro-tin plated	<a href="http://www.wago.com/216-109">www.wago.com/216-109</a>
	<b>Item no.: 216-110</b> Ferrule; Sleeve for 16 mm <sup>2</sup> / AWG 6; uninsulated; electro-tin plated	<a href="http://www.wago.com/216-110">www.wago.com/216-110</a>
	<b>Item no.: 216-121</b> Ferrule; Sleeve for 0.5 mm <sup>2</sup> / AWG 22; uninsulated; electro-tin plated	<a href="http://www.wago.com/216-121">www.wago.com/216-121</a>





Subject to changes. Please also observe the further product documentation!

	<b>Item no.: 216-122</b> Ferrule; Sleeve for 0.75 mm <sup>2</sup> / AWG 20; uninsulated; electro-tin plated	<a href="http://www.wago.com/216-122">www.wago.com/216-122</a>
	<b>Item no.: 216-123</b> Ferrule; Sleeve for 1 mm <sup>2</sup> / AWG 18; uninsulated; electro-tin plated	<a href="http://www.wago.com/216-123">www.wago.com/216-123</a>
	<b>Item no.: 216-124</b> Ferrule; Sleeve for 1.5 mm <sup>2</sup> / AWG 16; uninsulated; electro-tin plated	<a href="http://www.wago.com/216-124">www.wago.com/216-124</a>
	<b>Item no.: 216-131</b> Ferrule; Sleeve for 0.25 mm <sup>2</sup> / AWG 24; uninsulated; electro-tin plated	<a href="http://www.wago.com/216-131">www.wago.com/216-131</a>
	<b>Item no.: 216-132</b> Ferrule; Sleeve for 0.34 mm <sup>2</sup> / AWG 24; uninsulated; electro-tin plated	<a href="http://www.wago.com/216-132">www.wago.com/216-132</a>
	<b>Item no.: 216-141</b> Ferrule; Sleeve for 0.5 mm <sup>2</sup> / 20 AWG; uninsulated; electro-tin plated; electrolytic copper; gastight crimped; acc. to DIN 46228, Part 1/08.92	<a href="http://www.wago.com/216-141">www.wago.com/216-141</a>
	<b>Item no.: 216-142</b> Ferrule; Sleeve for 0.75 mm <sup>2</sup> / 18 AWG; uninsulated; electro-tin plated; electrolytic copper; gastight crimped; acc. to DIN 46228, Part 1/08.92	<a href="http://www.wago.com/216-142">www.wago.com/216-142</a>
	<b>Item no.: 216-143</b> Ferrule; Sleeve for 1 mm <sup>2</sup> / AWG 18; uninsulated; electro-tin plated; electrolytic copper; gastight crimped; acc. to DIN 46228, Part 1/08.92	<a href="http://www.wago.com/216-143">www.wago.com/216-143</a>
	<b>Item no.: 216-144</b> Ferrule; Sleeve for 1.5 mm <sup>2</sup> / AWG 16; uninsulated; electro-tin plated; electrolytic copper; gastight crimped; acc. to DIN 46228, Part 1/08.92	<a href="http://www.wago.com/216-144">www.wago.com/216-144</a>
	<b>Item no.: 216-151</b> Ferrule; Sleeve for 0.25 mm <sup>2</sup> / AWG 24; uninsulated; electro-tin plated	<a href="http://www.wago.com/216-151">www.wago.com/216-151</a>
	<b>Item no.: 216-152</b> Ferrule; Sleeve for 0.34 mm <sup>2</sup> / AWG 24; uninsulated; electro-tin plated	<a href="http://www.wago.com/216-152">www.wago.com/216-152</a>
	<b>Item no.: 216-207</b> Ferrule; Sleeve for 4 mm <sup>2</sup> / AWG 12; insulated; electro-tin plated; gray	<a href="http://www.wago.com/216-207">www.wago.com/216-207</a>
	<b>Item no.: 216-208</b> Ferrule; Sleeve for 6 mm <sup>2</sup> / AWG 10; insulated; electro-tin plated; electrolytic copper; gastight crimped; acc. to DIN 46228, Part 4/09.90; yellow	<a href="http://www.wago.com/216-208">www.wago.com/216-208</a>
	<b>Item no.: 216-209</b> Ferrule; Sleeve for 10 mm <sup>2</sup> / AWG 8; insulated; electro-tin plated; red	<a href="http://www.wago.com/216-209">www.wago.com/216-209</a>
	<b>Item no.: 216-210</b> Ferrule; Sleeve for 16 mm <sup>2</sup> / AWG 6; insulated; electro-tin plated; electrolytic copper; gastight crimped; acc. to DIN 46228, Part 4/09.90; blue	<a href="http://www.wago.com/216-210">www.wago.com/216-210</a>
	<b>Item no.: 216-221</b> Ferrule; Sleeve for 0.5 mm <sup>2</sup> / 20 AWG; insulated; electro-tin plated; white	<a href="http://www.wago.com/216-221">www.wago.com/216-221</a>
	<b>Item no.: 216-222</b> Ferrule; Sleeve for 0.75 mm <sup>2</sup> / 18 AWG; insulated; electro-tin plated; gray	<a href="http://www.wago.com/216-222">www.wago.com/216-222</a>

Subject to changes. Please also observe the further product documentation!

	<b>Item no.: 216-223</b> Ferrule; Sleeve for 1 mm <sup>2</sup> / AWG 18; insulated; electro-tin plated; red	<a href="http://www.wago.com/216-223">www.wago.com/216-223</a>
	<b>Item no.: 216-224</b> Ferrule; Sleeve for 1.5 mm <sup>2</sup> / AWG 16; insulated; electro-tin plated; black	<a href="http://www.wago.com/216-224">www.wago.com/216-224</a>
	<b>Item no.: 216-241</b> Ferrule; Sleeve for 0.5 mm <sup>2</sup> / 20 AWG; insulated; electro-tin plated; electrolytic copper; gastight crimped; acc. to DIN 46228, Part 4/09.90; white	<a href="http://www.wago.com/216-241">www.wago.com/216-241</a>
	<b>Item no.: 216-242</b> Ferrule; Sleeve for 0.75 mm <sup>2</sup> / 18 AWG; insulated; electro-tin plated; electrolytic copper; gastight crimped; acc. to DIN 46228, Part 4/09.90; gray	<a href="http://www.wago.com/216-242">www.wago.com/216-242</a>
	<b>Item no.: 216-243</b> Ferrule; Sleeve for 1 mm <sup>2</sup> / AWG 18; insulated; electro-tin plated; electrolytic copper; gastight crimped; acc. to DIN 46228, Part 4/09.90; red	<a href="http://www.wago.com/216-243">www.wago.com/216-243</a>
	<b>Item no.: 216-244</b> Ferrule; Sleeve for 1.5 mm <sup>2</sup> / AWG 16; insulated; electro-tin plated; electrolytic copper; gastight crimped; acc. to DIN 46228, Part 4/09.90; black	<a href="http://www.wago.com/216-244">www.wago.com/216-244</a>
	<b>Item no.: 216-246</b> Ferrule; Sleeve for 2.5 mm <sup>2</sup> / AWG 14; insulated; electro-tin plated; electrolytic copper; gastight crimped; acc. to DIN 46228, Part 4/09.90; blue	<a href="http://www.wago.com/216-246">www.wago.com/216-246</a>
	<b>Item no.: 216-262</b> Ferrule; Sleeve for 0.75 mm <sup>2</sup> / 18 AWG; insulated; electro-tin plated; electrolytic copper; gastight crimped; acc. to DIN 46228, Part 4/09.90; gray	<a href="http://www.wago.com/216-262">www.wago.com/216-262</a>
	<b>Item no.: 216-263</b> Ferrule; Sleeve for 1 mm <sup>2</sup> / AWG 18; insulated; electro-tin plated; electrolytic copper; gastight crimped; acc. to DIN 46228, Part 4/09.90; red	<a href="http://www.wago.com/216-263">www.wago.com/216-263</a>
	<b>Item no.: 216-264</b> Ferrule; Sleeve for 1.5 mm <sup>2</sup> / AWG 16; insulated; electro-tin plated; electrolytic copper; gastight crimped; acc. to DIN 46228, Part 4/09.90; black	<a href="http://www.wago.com/216-264">www.wago.com/216-264</a>
	<b>Item no.: 216-266</b> Ferrule; Sleeve for 2.5 mm <sup>2</sup> / AWG 14; insulated; electro-tin plated; electrolytic copper; gastight crimped; acc. to DIN 46228, Part 4/09.90; blue	<a href="http://www.wago.com/216-266">www.wago.com/216-266</a>
	<b>Item no.: 216-267</b> Ferrule; Sleeve for 4 mm <sup>2</sup> / AWG 12; insulated; electro-tin plated; electrolytic copper; gastight crimped; acc. to DIN 46228, Part 4/09.90; gray	<a href="http://www.wago.com/216-267">www.wago.com/216-267</a>
	<b>Item no.: 216-284</b> Ferrule; Sleeve for 1.5 mm <sup>2</sup> / AWG 16; insulated; electro-tin plated; electrolytic copper; gastight crimped; acc. to DIN 46228, Part 4/09.90; black	<a href="http://www.wago.com/216-284">www.wago.com/216-284</a>
	<b>Item no.: 216-286</b> Ferrule; Sleeve for 2.5 mm <sup>2</sup> / AWG 14; insulated; electro-tin plated; electrolytic copper; gastight crimped; acc. to DIN 46228, Part 4/09.90; blue	<a href="http://www.wago.com/216-286">www.wago.com/216-286</a>
	<b>Item no.: 216-287</b> Ferrule; Sleeve for 4 mm <sup>2</sup> / AWG 12; insulated; electro-tin plated; electrolytic copper; gastight crimped; acc. to DIN 46228, Part 4/09.90; gray	<a href="http://www.wago.com/216-287">www.wago.com/216-287</a>
	<b>Item no.: 216-288</b> Ferrule; Sleeve for 6 mm <sup>2</sup> / AWG 10; insulated; electro-tin plated; electrolytic copper; gastight crimped; acc. to DIN 46228, Part 4/09.90; yellow	<a href="http://www.wago.com/216-288">www.wago.com/216-288</a>

Subject to changes. Please also observe the further product documentation!

	<b>Item no.: 216-289</b> Ferrule; Sleeve for 10 mm <sup>2</sup> / AWG 8; insulated; electro-tin plated; electrolytic copper; gastight crimped; acc. to DIN 46228, Part 4/09.90; red	<a href="http://www.wago.com/216-289">www.wago.com/216-289</a>
	<b>Item no.: 216-321</b> Ferrule; Sleeve for 0.25 mm <sup>2</sup> / AWG 24; insulated; electro-tin plated; yellow	<a href="http://www.wago.com/216-321">www.wago.com/216-321</a>
	<b>Item no.: 216-322</b> Ferrule; Sleeve for 0.34 mm <sup>2</sup> / 22 AWG; insulated; electro-tin plated; green	<a href="http://www.wago.com/216-322">www.wago.com/216-322</a>
<b>Insulation stop</b>		
	<b>Item no.: 280-470</b> Insulation stop; 0.08 - 0.2 mm <sup>2</sup> "s" (0.14 mm <sup>2</sup> "f-st"); 5 pieces/strip; white	<a href="http://www.wago.com/280-470">www.wago.com/280-470</a>
	<b>Item no.: 280-471</b> Insulation stop; 0.25 - 0.5 mm <sup>2</sup> ; 5 pieces/strip; light gray	<a href="http://www.wago.com/280-471">www.wago.com/280-471</a>
	<b>Item no.: 280-472</b> Insulation stop; 0.75 - 1 mm <sup>2</sup> ; 5 pieces/strip	<a href="http://www.wago.com/280-472">www.wago.com/280-472</a>
<b>Test Accessories</b>		
	<b>Item no.: 209-170</b> Test plug adapter; 8.3 mm wide; for 4 mm Ø test plugs; suitable for 1.5 mm <sup>2</sup> - 10 mm <sup>2</sup> tbs; gray	<a href="http://www.wago.com/209-170">www.wago.com/209-170</a>
	<b>Item no.: 210-136</b> Test plug; 2 mm Ø; with 500 mm cable; red	<a href="http://www.wago.com/210-136">www.wago.com/210-136</a>
	<b>Item no.: 210-137</b> Test plug; 2.3 mm Ø; with 500 mm cable; yellow	<a href="http://www.wago.com/210-137">www.wago.com/210-137</a>
	<b>Item no.: 249-106</b> B-type test plug module; modular; 1,50 mm <sup>2</sup> ; gray	<a href="http://www.wago.com/249-106">www.wago.com/249-106</a>
	<b>Item no.: 249-107</b> B-type spacer module; modular; e.g., for bridging commoned terminal blocks; gray	<a href="http://www.wago.com/249-107">www.wago.com/249-107</a>
	<b>Item no.: 280-404</b> Test plug adapter; 5 mm wide; for test plug 210-137 (2.3 mm Ø); suitable for 1.5 mm <sup>2</sup> - 4 mm <sup>2</sup> tbs; gray	<a href="http://www.wago.com/280-404">www.wago.com/280-404</a>
	<b>Item no.: 280-418</b> Test plug module; modular; suitable for all WAGO 280 and 780 Series rail-mounted terminal blocks with jumper slots in the current bar; gray	<a href="http://www.wago.com/280-418">www.wago.com/280-418</a>
	<b>Item no.: 280-419</b> Spacer module; modular; bridging commoned terminal blocks; gray	<a href="http://www.wago.com/280-419">www.wago.com/280-419</a>
<b>End plate</b>		
	<b>Item no.: 284-336</b> Step-down cover plate; 1 mm thick; for 4-conductor 279-831, 280-833 and 281-652 terminal blocks; gray	<a href="http://www.wago.com/284-336">www.wago.com/284-336</a>
	<b>Item no.: 284-346</b> Step-down cover plate; 1 mm thick; for 4-conductor 279-831, 280-833 and 281-652 terminal blocks; orange	<a href="http://www.wago.com/284-346">www.wago.com/284-346</a>

Subject to changes. Please also observe the further product documentation!





**Item no.: 880-344**  
End and intermediate plate; 2.5 mm thick; gray

[www.wago.com/880-344](http://www.wago.com/880-344)



**Item no.: 880-345**  
Separator plate; 2 mm thick; oversized; gray

[www.wago.com/880-345](http://www.wago.com/880-345)



**Item no.: 880-346**  
End and intermediate plate; 2.5 mm thick; orange

[www.wago.com/880-346](http://www.wago.com/880-346)

**Item no.: 880-347**  
Separator plate; 2 mm thick; oversized; orange

[www.wago.com/880-347](http://www.wago.com/880-347)

#### assembling



**Item no.: 209-106**  
Mounting carrier; for isolated mounting on DIN 35 rails; gray

[www.wago.com/209-106](http://www.wago.com/209-106)



**Item no.: 709-153**  
Cover; Type 1; suitable for cover carrier, type 1; 1 m long; transparent

[www.wago.com/709-153](http://www.wago.com/709-153)

#### Marking accessories

**Item no.: 2009-115**  
WMB-Inline; for Smart Printer; 1500 pieces on roll; stretchable 5 - 5.2 mm; plain; snap-on type; white  
[www.wago.com/2009-115](http://www.wago.com/2009-115)



**Item no.: 2009-115/000-002**  
WMB-Inline; for Smart Printer; 1500 pieces on roll; stretchable 5 - 5.2 mm; plain; snap-on type; yellow  
[www.wago.com/2009-115/000-002](http://www.wago.com/2009-115/000-002)



**Item no.: 2009-115/000-006**  
WMB-Inline; for Smart Printer; 1500 pieces on roll; stretchable 5 - 5.2 mm; plain; snap-on type; white  
[www.wago.com/2009-115/000-006](http://www.wago.com/2009-115/000-006)

**Item no.: 2009-115/000-007**  
WMB-Inline; for Smart Printer; 1500 pieces on roll; stretchable 5 - 5.2 mm; plain; snap-on type; gray  
[www.wago.com/2009-115/000-007](http://www.wago.com/2009-115/000-007)



**Item no.: 2009-115/000-012**  
WMB-Inline; for Smart Printer; 1500 pieces on roll; stretchable 5 - 5.2 mm; plain; snap-on type; white  
[www.wago.com/2009-115/000-012](http://www.wago.com/2009-115/000-012)

**Item no.: 2009-115/000-017**  
WMB-Inline; for Smart Printer; 1500 pieces on roll; stretchable 5 - 5.2 mm; plain; snap-on type; white  
[www.wago.com/2009-115/000-017](http://www.wago.com/2009-115/000-017)







**Item no.: 2009-115/000-023**  
WMB-Inline; for Smart Printer; 1500 pieces on roll; stretchable 5 - 5.2 mm; plain; snap-on type; green  
[www.wago.com/2009-115/000-023](http://www.wago.com/2009-115/000-023)

**Item no.: 2009-115/000-024**  
WMB-Inline; for Smart Printer; 1500 pieces on roll; stretchable 5 - 5.2 mm; plain; snap-on type; white  
[www.wago.com/2009-115/000-024](http://www.wago.com/2009-115/000-024)







**Item no.: 2009-145**  
Mini-WSB Inline; for Smart Printer; 1700 pieces on roll; stretchable 5 - 5.2 mm; plain; snap-on type;  
[www.wago.com/2009-145](http://www.wago.com/2009-145)

Subject to changes. Please also observe the further product documentation!





white

	<b>Item no.: 2009-145/000-002</b> Mini-WSB Inline; for Smart Printer; 1700 pieces on roll; stretchable 5 - 5.2 mm; plain; snap-on type; white	<a href="http://www.wago.com/2009-145/000-002">www.wago.com/2009-145/000-002</a>
	<b>Item no.: 2009-145/000-005</b> Mini-WSB Inline; for Smart Printer; 1700 pieces on roll; stretchable 5 - 5.2 mm; plain; snap-on type; red	<a href="http://www.wago.com/2009-145/000-005">www.wago.com/2009-145/000-005</a>
	<b>Item no.: 2009-145/000-006</b> Mini-WSB Inline; for Smart Printer; 1700 pieces on roll; stretchable 5 - 5.2 mm; plain; snap-on type; blue	<a href="http://www.wago.com/2009-145/000-006">www.wago.com/2009-145/000-006</a>
	<b>Item no.: 2009-145/000-007</b> Mini-WSB Inline; for Smart Printer; 1700 pieces on roll; stretchable 5 - 5.2 mm; plain; snap-on type; white	<a href="http://www.wago.com/2009-145/000-007">www.wago.com/2009-145/000-007</a>
	<b>Item no.: 2009-145/000-012</b> Mini-WSB Inline; for Smart Printer; 1700 pieces on roll; stretchable 5 - 5.2 mm; plain; snap-on type; orange	<a href="http://www.wago.com/2009-145/000-012">www.wago.com/2009-145/000-012</a>
	<b>Item no.: 2009-145/000-023</b> Mini-WSB Inline; for Smart Printer; 1700 pieces on roll; stretchable 5 - 5.2 mm; plain; snap-on type; green	<a href="http://www.wago.com/2009-145/000-023">www.wago.com/2009-145/000-023</a>
	<b>Item no.: 2009-145/000-024</b> Mini-WSB Inline; for Smart Printer; 1700 pieces on roll; stretchable 5 - 5.2 mm; plain; snap-on type; violet	<a href="http://www.wago.com/2009-145/000-024">www.wago.com/2009-145/000-024</a>
	<b>Item no.: 248-501</b> Miniature WSB Quick marking system; plain; Marker width 5 mm; 10 strips with 10 markers per card	<a href="http://www.wago.com/248-501">www.wago.com/248-501</a>
	<b>Item no.: 248-501/000-002</b> Mini-WSB marking card; as card; not stretchable; plain; snap-on type; yellow	<a href="http://www.wago.com/248-501/000-002">www.wago.com/248-501/000-002</a>
	<b>Item no.: 248-501/000-005</b> Mini-WSB marking card; as card; not stretchable; plain; snap-on type; red	<a href="http://www.wago.com/248-501/000-005">www.wago.com/248-501/000-005</a>
	<b>Item no.: 248-501/000-006</b> Mini-WSB marking card; as card; not stretchable; plain; snap-on type; blue	<a href="http://www.wago.com/248-501/000-006">www.wago.com/248-501/000-006</a>
	<b>Item no.: 248-501/000-007</b> Mini-WSB marking card; as card; not stretchable; plain; snap-on type; gray	<a href="http://www.wago.com/248-501/000-007">www.wago.com/248-501/000-007</a>
	<b>Item no.: 248-501/000-012</b> Mini-WSB marking card; as card; not stretchable; plain; snap-on type; orange	<a href="http://www.wago.com/248-501/000-012">www.wago.com/248-501/000-012</a>

Subject to changes. Please also observe the further product documentation!







	<p><b>Item no.: 248-501/000-017</b> Mini-WSB marking card; as card; not stretchable; plain; snap-on type; light green</p>	<p><a href="http://www.wago.com/248-501/000-017">www.wago.com/248-501/000-017</a></p>
	<p><b>Item no.: 248-501/000-023</b> Mini-WSB marking card; as card; not stretchable; plain; snap-on type; green</p>	<p><a href="http://www.wago.com/248-501/000-023">www.wago.com/248-501/000-023</a></p>
	<p><b>Item no.: 248-501/000-024</b> Mini-WSB marking card; as card; not stretchable; plain; snap-on type; violet</p>	<p><a href="http://www.wago.com/248-501/000-024">www.wago.com/248-501/000-024</a></p>
	<p><b>Item no.: 249-105</b> Group marker carrier; gray</p>	<p><a href="http://www.wago.com/249-105">www.wago.com/249-105</a></p>
	<p><b>Item no.: 793-501</b> WMB marking card; as card; not stretchable; plain; snap-on type; white</p>	<p><a href="http://www.wago.com/793-501">www.wago.com/793-501</a></p>
	<p><b>Item no.: 793-501/000-002</b> WMB marking card; as card; not stretchable; plain; snap-on type; yellow</p>	<p><a href="http://www.wago.com/793-501/000-002">www.wago.com/793-501/000-002</a></p>
	<p><b>Item no.: 793-501/000-005</b> WMB marking card; as card; not stretchable; plain; snap-on type; red</p>	<p><a href="http://www.wago.com/793-501/000-005">www.wago.com/793-501/000-005</a></p>
	<p><b>Item no.: 793-501/000-006</b> WMB marking card; as card; not stretchable; plain; snap-on type; blue</p>	<p><a href="http://www.wago.com/793-501/000-006">www.wago.com/793-501/000-006</a></p>
	<p><b>Item no.: 793-501/000-007</b> WMB marking card; as card; not stretchable; plain; snap-on type; gray</p>	<p><a href="http://www.wago.com/793-501/000-007">www.wago.com/793-501/000-007</a></p>
	<p><b>Item no.: 793-501/000-012</b> WMB marking card; as card; not stretchable; plain; snap-on type; orange</p>	<p><a href="http://www.wago.com/793-501/000-012">www.wago.com/793-501/000-012</a></p>
	<p><b>Item no.: 793-501/000-017</b> WMB marking card; as card; not stretchable; plain; snap-on type; light green</p>	<p><a href="http://www.wago.com/793-501/000-017">www.wago.com/793-501/000-017</a></p>
	<p><b>Item no.: 793-501/000-023</b> WMB marking card; as card; not stretchable; plain; snap-on type; green</p>	<p><a href="http://www.wago.com/793-501/000-023">www.wago.com/793-501/000-023</a></p>
	<p><b>Item no.: 793-501/000-024</b> WMB marking card; as card; not stretchable; plain; snap-on type; violet</p>	<p><a href="http://www.wago.com/793-501/000-024">www.wago.com/793-501/000-024</a></p>
	<p><b>Item no.: 793-5501</b> WMB marking card; as card; for terminal block width 5 - 17.5 mm; stretchable 5 - 5.2 mm; plain; snap-on type; white</p>	<p><a href="http://www.wago.com/793-5501">www.wago.com/793-5501</a></p>

Subject to changes. Please also observe the further product documentation!

	<b>Item no.: 793-5501/000-002</b> WMB marking card; as card; for terminal block width 5 - 17.5 mm; stretchable 5 - 5.2 mm; plain; snap-on type; yellow	<a href="http://www.wago.com/793-5501/000-002">www.wago.com/793-5501/000-002</a>
	<b>Item no.: 793-5501/000-005</b> WMB marking card; as card; for terminal block width 5 - 17.5 mm; stretchable 5 - 5.2 mm; plain; snap-on type; red	<a href="http://www.wago.com/793-5501/000-005">www.wago.com/793-5501/000-005</a>
	<b>Item no.: 793-5501/000-006</b> WMB marking card; as card; for terminal block width 5 - 17.5 mm; stretchable 5 - 5.2 mm; plain; snap-on type; blue	<a href="http://www.wago.com/793-5501/000-006">www.wago.com/793-5501/000-006</a>
	<b>Item no.: 793-5501/000-007</b> WMB marking card; as card; for terminal block width 5 - 17.5 mm; stretchable 5 - 5.2 mm; plain; snap-on type; gray	<a href="http://www.wago.com/793-5501/000-007">www.wago.com/793-5501/000-007</a>
	<b>Item no.: 793-5501/000-012</b> WMB marking card; as card; for terminal block width 5 - 17.5 mm; stretchable 5 - 5.2 mm; plain; snap-on type; orange	<a href="http://www.wago.com/793-5501/000-012">www.wago.com/793-5501/000-012</a>
	<b>Item no.: 793-5501/000-017</b> WMB marking card; as card; for terminal block width 5 - 17.5 mm; stretchable 5 - 5.2 mm; plain; snap-on type; green	<a href="http://www.wago.com/793-5501/000-017">www.wago.com/793-5501/000-017</a>
	<b>Item no.: 793-5501/000-023</b> WMB marking card; as card; for terminal block width 5 - 17.5 mm; stretchable 5 - 5.2 mm; plain; snap-on type; light green	<a href="http://www.wago.com/793-5501/000-023">www.wago.com/793-5501/000-023</a>
	<b>Item no.: 793-5501/000-024</b> WMB marking card; as card; for terminal block width 5 - 17.5 mm; stretchable 5 - 5.2 mm; plain; snap-on type; violet	<a href="http://www.wago.com/793-5501/000-024">www.wago.com/793-5501/000-024</a>
<b>Carrier rail</b>		
	<b>Item no.: 210-112</b> Steel carrier rail; 35 x 7.5 mm; 1 mm thick; 2 m long; slotted; according to EN 60715; "Hole width 25 mm	<a href="http://www.wago.com/210-112">www.wago.com/210-112</a>
	<b>Item no.: 210-113</b> Steel carrier rail; 35 x 7.5 mm; 1 mm thick; 2 m long; unslotted; according to EN 60715	<a href="http://www.wago.com/210-113">www.wago.com/210-113</a>
	<b>Item no.: 210-114</b> Steel carrier rail; 35 x 15 mm; 1.5 mm thick; 2 m long; unslotted; similar to EN 60715	<a href="http://www.wago.com/210-114">www.wago.com/210-114</a>
	<b>Item no.: 210-115</b> Steel carrier rail; 35 x 7.5 mm; 1 mm thick; 2 m long; slotted; according to EN 60715; "Hole width 18 mm	<a href="http://www.wago.com/210-115">www.wago.com/210-115</a>
	<b>Item no.: 210-118</b> Steel carrier rail; 35 x 15 mm; 2.3 mm thick; 2 m long; unslotted; according to EN 60715	<a href="http://www.wago.com/210-118">www.wago.com/210-118</a>
	<b>Item no.: 210-162</b> Steel carrier rail; 35 x 7.5 mm; slotted; 1 mm thick	<a href="http://www.wago.com/210-162">www.wago.com/210-162</a>
	<b>Item no.: 210-196</b> Aluminum carrier rail; 35 x 8.2 mm; 1.6 mm thick; 2 m long; unslotted; similar to EN 60715; silver-	<a href="http://www.wago.com/210-196">www.wago.com/210-196</a>

Subject to changes. Please also observe the further product documentation!

colored

	<b>Item no.: 210-197</b> Steel carrier rail; 35 x 15 mm; 1.5 mm thick; 2 m long; slotted; similar to EN 60715	<a href="http://www.wago.com/210-197">www.wago.com/210-197</a>
	<b>Item no.: 210-198</b> Copper carrier rail; 35 x 15 mm; 2.3 mm thick; 2 m long; unslotted; according to EN 60715; copper-colored	<a href="http://www.wago.com/210-198">www.wago.com/210-198</a>
	<b>Item no.: 210-504</b> Steel carrier rail; 35 x 7.5 mm; 1 mm thick; 2 m long; slotted; galvanized; according to EN 60715	<a href="http://www.wago.com/210-504">www.wago.com/210-504</a>
	<b>Item no.: 210-505</b> Steel carrier rail; 35 x 7.5 mm; 1 mm thick; 2 m long; unslotted; galvanized; according to EN 60715	<a href="http://www.wago.com/210-505">www.wago.com/210-505</a>
	<b>Item no.: 210-506</b> Steel carrier rail; 35 x 15 mm; 1.5 mm thick; 2 m long; unslotted; galvanized; similar to EN 60715	<a href="http://www.wago.com/210-506">www.wago.com/210-506</a>
	<b>Item no.: 210-508</b> Steel carrier rail; 35 x 15 mm; 1.5 mm thick; 2 m long; slotted; galvanized; similar to EN 60715	<a href="http://www.wago.com/210-508">www.wago.com/210-508</a>

## Downloads

### Documentation

#### Additional Information

Technical explanations	Apr 3, 2019	pdf 2.1 MB	Download
------------------------	-------------	---------------	----------

## CAD/CAE-Data

### CAD data

2D/3D Models 880-831	URL	Download
----------------------	-----	----------

### CAE data

EPLAN Data Portal 880-831	URL	Download
---------------------------	-----	----------

WSCAD Universe 880-831	URL	Download
------------------------	-----	----------

## Installation Notes

Subject to changes. Please also observe the further product documentation!

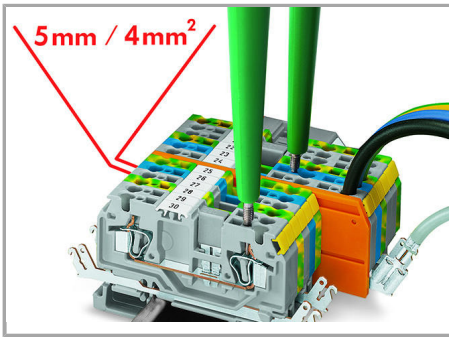

**Features:**

- 2-, 3- and 4-conductor terminal blocks, just 5 mm wide
- 
- Conductor cross section up to 4 mm<sup>2</sup> (per VDE 0281) or 12 AWG with ferrule (Item No. 216-206) 2.5 mm<sup>2</sup> rubber-insulated conductors with outer diameter up to 4.4 mm
- 
- Shield contact, solder/quick-connect contact 6.3 (2 x 2.8) mm
- 
- Test plug, red, 2 mm Ø
- 
- Test plug, yellow, 2.3 mm Ø
- 
- WMB markers
- 
- Mini-WSB markers, on both sides
- 
- Commoning with WAGO jumper systems
- 

**Conductor termination**

Subject to changes. Please also observe the further product documentation!

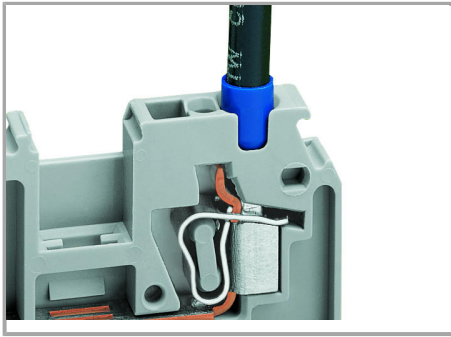

Using a 12 AWG conductor with ferrule.

Item No. 216-206

### Testing

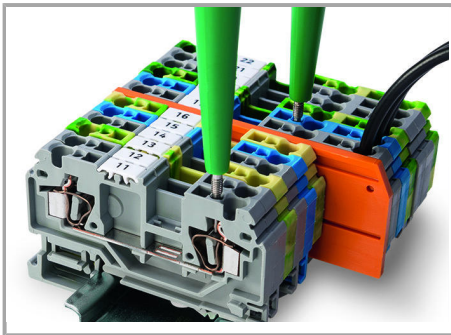

880 Series terminal blocks have an additional test slot for 2-pole voltage tester

Subject to changes. Please also observe the further product documentation!