

**Data sheet | Item number: 870-590/281-410**

Component terminal block; triple-deck; with diode 1N4007; anode, left side;  
for DIN-rail 35 x 15 and 35 x 7.5; 2.5 mm<sup>2</sup>; CAGE CLAMP®; 2,50 mm<sup>2</sup>; gray

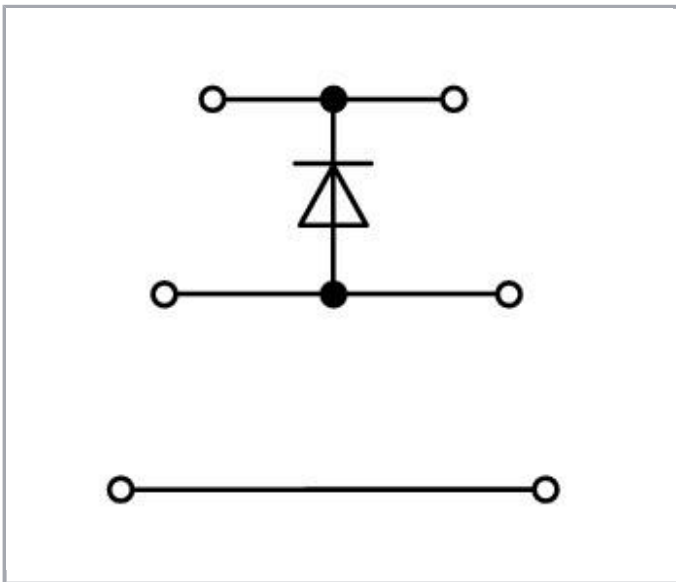

[www.wago.com/870-590/281-410](http://www.wago.com/870-590/281-410)

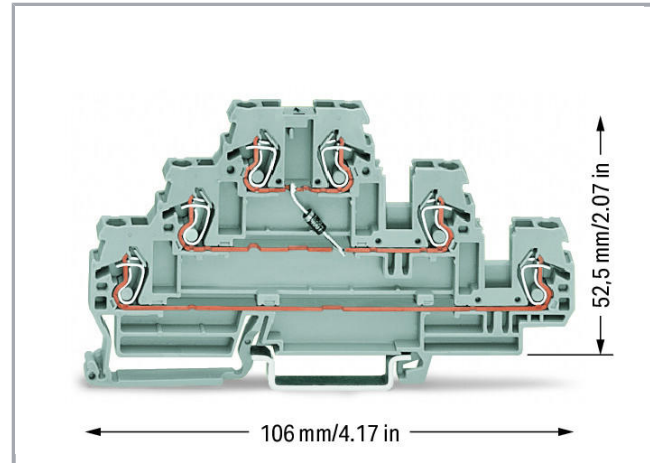
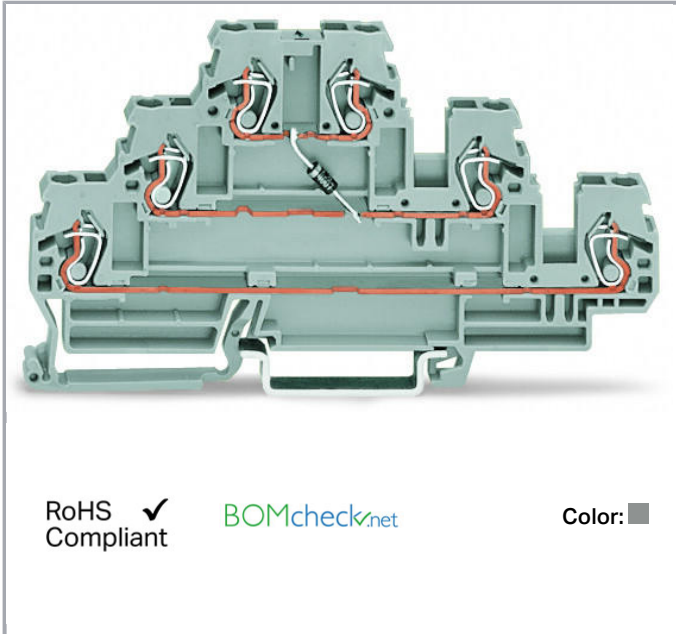

**Item description**

**Safety information 1:**

Max. insulation diameter: 4.4 mm

Subject to changes. Please also observe the further product documentation!

WAGO Kontakttechnik GmbH & Co. KG  
Hansastr. 27  
32423 Minden  
Phone: +49571 887-0 | Fax: +49571 887-169  
Email: [info.de@wago.com](mailto:info.de@wago.com) | Web: [www.wago.com](http://www.wago.com)

Do you have any questions about our products?  
We are always happy to take your call at +49 (571) 887-44222.



## Data

### Electrical data

Nominal voltage	250 V
Reverse voltage	1,000 V

### Ratings per IEC/EN 60664-1

Ratings per	IEC/EN 60947-7-1
Rated current	0.5 A

### Connection data

Connection technology	CAGE CLAMP®
Actuation type	Operating tool
Connectable conductor materials	Copper
Solid conductor	0.08 ... 2.5 mm <sup>2</sup> / 28 ... 12 AWG
Fine-stranded conductor	0.08 ... 4 mm <sup>2</sup> / 28 ... 12 AWG
Strip length	6 ... 7 mm / 0.24 ... 0.28 inch
Total number of connection points	6
Total number of potentials	2
Number of levels	3
Type of wiring	Front-entry wiring

### Geometrical Data

Width	5 mm / 0.197 inch
Height from upper-edge of DIN-35 rail	52.5 mm / 2.067 inch
Depth	106 mm / 4.173 inch

### Mechanical data

Design	horizontal
Type of mounting	DIN-35 rail
Marking level	Side marking

### Material Data

Color	gray
Insulating material	Polyamide 66 (PA 66)

Subject to changes. Please also observe the further product documentation!

Fire load	0.275 MJ
Weight	17.2 g





### Commercial data

Product Group	16 (Rail Mounted Terminal Block with CCC)
Packaging type	BOX
Country of origin	DE
GTIN	4045454198749
Customs Tariff No.	85369010000







### Counterpart

### Compatible products

#### Jumper

	<b>Item no.: 870-402</b> Push-in type jumper bar; insulated; 2-way; Nominal current 18 A; light gray	<a href="http://www.wago.com/870-402">www.wago.com/870-402</a>
	<b>Item no.: 870-403</b> Push-in type jumper bar; insulated; 3-way; Nominal current 18 A; light gray	<a href="http://www.wago.com/870-403">www.wago.com/870-403</a>
	<b>Item no.: 870-404</b> Push-in type jumper bar; insulated; 4-way; Nominal current 18 A; light gray	<a href="http://www.wago.com/870-404">www.wago.com/870-404</a>
	<b>Item no.: 870-405</b> Push-in type jumper bar; insulated; 5-way; Nominal current 18 A; light gray	<a href="http://www.wago.com/870-405">www.wago.com/870-405</a>
	<b>Item no.: 870-405/011-000</b> Ready-made push-in type jumper bar; insulated; 3-way (1-3-5); Nominal current 18 A; light gray	<a href="http://www.wago.com/870-405/011-000">www.wago.com/870-405/011-000</a>
	<b>Item no.: 870-406</b> Push-in type jumper bar; insulated; 6-way; Nominal current 18 A; light gray	<a href="http://www.wago.com/870-406">www.wago.com/870-406</a>
	<b>Item no.: 870-407</b> Push-in type jumper bar; insulated; 7-way; Nominal current 18 A; light gray	<a href="http://www.wago.com/870-407">www.wago.com/870-407</a>

Subject to changes. Please also observe the further product documentation!

	<b>Item no.: 870-407/011-000</b> Ready-made push-in type jumper bar; insulated; 1-3-5-7; Nominal current 18 A; light gray	<a href="http://www.wago.com/870-407/011-000">www.wago.com/870-407/011-000</a>
	<b>Item no.: 870-408</b> Push-in type jumper bar; insulated; 8-way; Nominal current 18 A; light gray	<a href="http://www.wago.com/870-408">www.wago.com/870-408</a>
	<b>Item no.: 870-409</b> Push-in type jumper bar; insulated; 9-way; Nominal current 18 A; light gray	<a href="http://www.wago.com/870-409">www.wago.com/870-409</a>
	<b>Item no.: 870-409/011-000</b> Ready-made push-in type jumper bar; insulated; 1-3-5-7-9; Nominal current 18 A; light gray	<a href="http://www.wago.com/870-409/011-000">www.wago.com/870-409/011-000</a>
	<b>Item no.: 870-410</b> Push-in type jumper bar; insulated; 10-way; Nominal current 18 A; light gray	<a href="http://www.wago.com/870-410">www.wago.com/870-410</a>
	<b>Item no.: 870-433</b> Push-in type jumper bar; insulated; from 1 to 3; Nominal current 18 A; light gray	<a href="http://www.wago.com/870-433">www.wago.com/870-433</a>
	<b>Item no.: 870-434</b> Push-in type jumper bar; insulated; from 1 to 4; Nominal current 18 A; light gray	<a href="http://www.wago.com/870-434">www.wago.com/870-434</a>
	<b>Item no.: 870-435</b> Push-in type jumper bar; insulated; from 1 to 5; Nominal current 18 A; light gray	<a href="http://www.wago.com/870-435">www.wago.com/870-435</a>
	<b>Item no.: 870-436</b> Push-in type jumper bar; insulated; from 1 to 6; Nominal current 18 A; light gray	<a href="http://www.wago.com/870-436">www.wago.com/870-436</a>
	<b>Item no.: 870-437</b> Push-in type jumper bar; insulated; from 1 to 7; Nominal current 18 A; light gray	<a href="http://www.wago.com/870-437">www.wago.com/870-437</a>
	<b>Item no.: 870-438</b> Push-in type jumper bar; insulated; from 1 to 8; Nominal current 18 A; light gray	<a href="http://www.wago.com/870-438">www.wago.com/870-438</a>
	<b>Item no.: 870-439</b> Push-in type jumper bar; insulated; from 1 to 9; Nominal current 18 A; light gray	<a href="http://www.wago.com/870-439">www.wago.com/870-439</a>
	<b>Item no.: 870-440</b> Push-in type jumper bar; insulated; from 1 to 10; Nominal current 18 A; light gray	<a href="http://www.wago.com/870-440">www.wago.com/870-440</a>
<b>End plate</b>		
	<b>Item no.: 870-568</b> End and intermediate plate; 2 mm thick; gray	<a href="http://www.wago.com/870-568">www.wago.com/870-568</a>
	<b>Item no.: 870-569</b> End and intermediate plate; 2 mm thick; orange	<a href="http://www.wago.com/870-569">www.wago.com/870-569</a>
<b>Insulation stop</b>		
	<b>Item no.: 280-470</b> Insulation stop; 0.08 - 0.2 mm <sup>2</sup> "s" (0.14 mm <sup>2</sup> "f-st"); 5 pieces/strip; white	<a href="http://www.wago.com/280-470">www.wago.com/280-470</a>
	<b>Item no.: 280-471</b> Insulation stop; 0.25 - 0.5 mm <sup>2</sup> ; 5 pieces/strip; light gray	<a href="http://www.wago.com/280-471">www.wago.com/280-471</a>











Subject to changes. Please also observe the further product documentation!



**Item no.: 280-472**  
Insulation stop; 0.75 - 1 mm<sup>2</sup>; 5 pieces/strip

[www.wago.com/280-472](http://www.wago.com/280-472)







**Marking accessories**

	<b>Item no.: 2009-115</b> WMB-Inline; for Smart Printer; 1500 pieces on roll; stretchable 5 - 5.2 mm; plain; snap-on type; white	<a href="http://www.wago.com/2009-115">www.wago.com/2009-115</a>
	<b>Item no.: 2009-115/000-002</b> WMB-Inline; for Smart Printer; 1500 pieces on roll; stretchable 5 - 5.2 mm; plain; snap-on type; yellow	<a href="http://www.wago.com/2009-115/000-002">www.wago.com/2009-115/000-002</a>
	<b>Item no.: 2009-115/000-006</b> WMB-Inline; for Smart Printer; 1500 pieces on roll; stretchable 5 - 5.2 mm; plain; snap-on type; white	<a href="http://www.wago.com/2009-115/000-006">www.wago.com/2009-115/000-006</a>
	<b>Item no.: 2009-115/000-007</b> WMB-Inline; for Smart Printer; 1500 pieces on roll; stretchable 5 - 5.2 mm; plain; snap-on type; gray	<a href="http://www.wago.com/2009-115/000-007">www.wago.com/2009-115/000-007</a>
	<b>Item no.: 2009-115/000-012</b> WMB-Inline; for Smart Printer; 1500 pieces on roll; stretchable 5 - 5.2 mm; plain; snap-on type; white	<a href="http://www.wago.com/2009-115/000-012">www.wago.com/2009-115/000-012</a>
	<b>Item no.: 2009-115/000-017</b> WMB-Inline; for Smart Printer; 1500 pieces on roll; stretchable 5 - 5.2 mm; plain; snap-on type; white	<a href="http://www.wago.com/2009-115/000-017">www.wago.com/2009-115/000-017</a>
	<b>Item no.: 2009-115/000-023</b> WMB-Inline; for Smart Printer; 1500 pieces on roll; stretchable 5 - 5.2 mm; plain; snap-on type; green	<a href="http://www.wago.com/2009-115/000-023">www.wago.com/2009-115/000-023</a>
	<b>Item no.: 2009-115/000-024</b> WMB-Inline; for Smart Printer; 1500 pieces on roll; stretchable 5 - 5.2 mm; plain; snap-on type; white	<a href="http://www.wago.com/2009-115/000-024">www.wago.com/2009-115/000-024</a>
	<b>Item no.: 2009-145</b> Mini-WSB Inline; for Smart Printer; 1700 pieces on roll; stretchable 5 - 5.2 mm; plain; snap-on type; white	<a href="http://www.wago.com/2009-145">www.wago.com/2009-145</a>
	<b>Item no.: 2009-145/000-002</b> Mini-WSB Inline; for Smart Printer; 1700 pieces on roll; stretchable 5 - 5.2 mm; plain; snap-on type; white	<a href="http://www.wago.com/2009-145/000-002">www.wago.com/2009-145/000-002</a>
	<b>Item no.: 2009-145/000-005</b> Mini-WSB Inline; for Smart Printer; 1700 pieces on roll; stretchable 5 - 5.2 mm; plain; snap-on type; red	<a href="http://www.wago.com/2009-145/000-005">www.wago.com/2009-145/000-005</a>
	<b>Item no.: 2009-145/000-006</b> Mini-WSB Inline; for Smart Printer; 1700 pieces on roll; stretchable 5 - 5.2 mm; plain; snap-on type; blue	<a href="http://www.wago.com/2009-145/000-006">www.wago.com/2009-145/000-006</a>
	<b>Item no.: 2009-145/000-007</b> Mini-WSB Inline; for Smart Printer; 1700 pieces on roll; stretchable 5 - 5.2 mm; plain; snap-on type; white	<a href="http://www.wago.com/2009-145/000-007">www.wago.com/2009-145/000-007</a>







Subject to changes. Please also observe the further product documentation!

WAGO Kontakttechnik GmbH & Co. KG  
Hansastr. 27  
32423 Minden  
Phone: +49571 887-0 | Fax: +49571 887-169  
Email: [info.de@wago.com](mailto:info.de@wago.com) | Web: [www.wago.com](http://www.wago.com)

Do you have any questions about our products?  
We are always happy to take your call at +49 (571) 887-44222.

	<p><b>Item no.: 2009-145/000-012</b>                  Mini-WSB Inline; for Smart Printer; 1700 pieces on roll; stretchable 5 - 5.2 mm; plain; snap-on type; orange</p>	<p><a href="http://www.wago.com/2009-145/000-012">www.wago.com/2009-145/000-012</a></p>
	<p><b>Item no.: 2009-145/000-023</b>                  Mini-WSB Inline; for Smart Printer; 1700 pieces on roll; stretchable 5 - 5.2 mm; plain; snap-on type; green</p>	<p><a href="http://www.wago.com/2009-145/000-023">www.wago.com/2009-145/000-023</a></p>
	<p><b>Item no.: 2009-145/000-024</b>                  Mini-WSB Inline; for Smart Printer; 1700 pieces on roll; stretchable 5 - 5.2 mm; plain; snap-on type; violet</p>	<p><a href="http://www.wago.com/2009-145/000-024">www.wago.com/2009-145/000-024</a></p>
	<p><b>Item no.: 248-501</b>                  Miniature WSB Quick marking system; plain; Marker width 5 mm; 10 strips with 10 markers per card</p>	<p><a href="http://www.wago.com/248-501">www.wago.com/248-501</a></p>
	<p><b>Item no.: 248-501/000-002</b>                  Mini-WSB marking card; as card; not stretchable; plain; snap-on type; yellow</p>	<p><a href="http://www.wago.com/248-501/000-002">www.wago.com/248-501/000-002</a></p>
	<p><b>Item no.: 248-501/000-005</b>                  Mini-WSB marking card; as card; not stretchable; plain; snap-on type; red</p>	<p><a href="http://www.wago.com/248-501/000-005">www.wago.com/248-501/000-005</a></p>
	<p><b>Item no.: 248-501/000-006</b>                  Mini-WSB marking card; as card; not stretchable; plain; snap-on type; blue</p>	<p><a href="http://www.wago.com/248-501/000-006">www.wago.com/248-501/000-006</a></p>
	<p><b>Item no.: 248-501/000-007</b>                  Mini-WSB marking card; as card; not stretchable; plain; snap-on type; gray</p>	<p><a href="http://www.wago.com/248-501/000-007">www.wago.com/248-501/000-007</a></p>
	<p><b>Item no.: 248-501/000-012</b>                  Mini-WSB marking card; as card; not stretchable; plain; snap-on type; orange</p>	<p><a href="http://www.wago.com/248-501/000-012">www.wago.com/248-501/000-012</a></p>
	<p><b>Item no.: 248-501/000-017</b>                  Mini-WSB marking card; as card; not stretchable; plain; snap-on type; light green</p>	<p><a href="http://www.wago.com/248-501/000-017">www.wago.com/248-501/000-017</a></p>
	<p><b>Item no.: 248-501/000-023</b>                  Mini-WSB marking card; as card; not stretchable; plain; snap-on type; green</p>	<p><a href="http://www.wago.com/248-501/000-023">www.wago.com/248-501/000-023</a></p>
	<p><b>Item no.: 248-501/000-024</b>                  Mini-WSB marking card; as card; not stretchable; plain; snap-on type; violet</p>	<p><a href="http://www.wago.com/248-501/000-024">www.wago.com/248-501/000-024</a></p>
	<p><b>Item no.: 709-177</b>                  Marking strips; on reel; 7.5 mm wide; not stretchable; plain; snap-on type; translucent</p>	<p><a href="http://www.wago.com/709-177">www.wago.com/709-177</a></p>
	<p><b>Item no.: 709-178</b>                  Marking strips; on reel; 7.5 mm wide; not stretchable; plain; snap-on type; white</p>	<p><a href="http://www.wago.com/709-178">www.wago.com/709-178</a></p>

Subject to changes. Please also observe the further product documentation!

	<p><b>Item no.: 709-196</b> Marking strips; for laser printer; translucent</p>	<a href="http://www.wago.com/709-196">www.wago.com/709-196</a>
	<p><b>Item no.: 709-198</b> Marking strips; white</p>	<a href="http://www.wago.com/709-198">www.wago.com/709-198</a>
	<p><b>Item no.: 793-501</b> WMB marking card; as card; not stretchable; plain; snap-on type; white</p>	<a href="http://www.wago.com/793-501">www.wago.com/793-501</a>
	<p><b>Item no.: 793-501/000-002</b> WMB marking card; as card; not stretchable; plain; snap-on type; yellow</p>	<a href="http://www.wago.com/793-501/000-002">www.wago.com/793-501/000-002</a>
	<p><b>Item no.: 793-501/000-005</b> WMB marking card; as card; not stretchable; plain; snap-on type; red</p>	<a href="http://www.wago.com/793-501/000-005">www.wago.com/793-501/000-005</a>
	<p><b>Item no.: 793-501/000-006</b> WMB marking card; as card; not stretchable; plain; snap-on type; blue</p>	<a href="http://www.wago.com/793-501/000-006">www.wago.com/793-501/000-006</a>
	<p><b>Item no.: 793-501/000-007</b> WMB marking card; as card; not stretchable; plain; snap-on type; gray</p>	<a href="http://www.wago.com/793-501/000-007">www.wago.com/793-501/000-007</a>
	<p><b>Item no.: 793-501/000-012</b> WMB marking card; as card; not stretchable; plain; snap-on type; orange</p>	<a href="http://www.wago.com/793-501/000-012">www.wago.com/793-501/000-012</a>
	<p><b>Item no.: 793-501/000-017</b> WMB marking card; as card; not stretchable; plain; snap-on type; light green</p>	<a href="http://www.wago.com/793-501/000-017">www.wago.com/793-501/000-017</a>
	<p><b>Item no.: 793-501/000-023</b> WMB marking card; as card; not stretchable; plain; snap-on type; green</p>	<a href="http://www.wago.com/793-501/000-023">www.wago.com/793-501/000-023</a>
	<p><b>Item no.: 793-501/000-024</b> WMB marking card; as card; not stretchable; plain; snap-on type; violet</p>	<a href="http://www.wago.com/793-501/000-024">www.wago.com/793-501/000-024</a>
	<p><b>Item no.: 793-5501</b> WMB marking card; as card; for terminal block width 5 - 17.5 mm; stretchable 5 - 5.2 mm; plain; snap-on type; white</p>	<a href="http://www.wago.com/793-5501">www.wago.com/793-5501</a>
	<p><b>Item no.: 793-5501/000-002</b> WMB marking card; as card; for terminal block width 5 - 17.5 mm; stretchable 5 - 5.2 mm; plain; snap-on type; yellow</p>	<a href="http://www.wago.com/793-5501/000-002">www.wago.com/793-5501/000-002</a>
	<p><b>Item no.: 793-5501/000-005</b> WMB marking card; as card; for terminal block width 5 - 17.5 mm; stretchable 5 - 5.2 mm; plain; snap-on type; red</p>	<a href="http://www.wago.com/793-5501/000-005">www.wago.com/793-5501/000-005</a>
	<p><b>Item no.: 793-5501/000-006</b></p>	

Subject to changes. Please also observe the further product documentation!

WMB marking card; as card; for terminal block width 5 - 17.5 mm; stretchable 5 - 5.2 mm; plain; snap-on type; blue

[www.wago.com/793-5501/000-006](http://www.wago.com/793-5501/000-006)

**Item no.: 793-5501/000-007**

WMB marking card; as card; for terminal block width 5 - 17.5 mm; stretchable 5 - 5.2 mm; plain; snap-on type; gray

[www.wago.com/793-5501/000-007](http://www.wago.com/793-5501/000-007)

**Item no.: 793-5501/000-012**

WMB marking card; as card; for terminal block width 5 - 17.5 mm; stretchable 5 - 5.2 mm; plain; snap-on type; orange

[www.wago.com/793-5501/000-012](http://www.wago.com/793-5501/000-012)



**Item no.: 793-5501/000-017**

WMB marking card; as card; for terminal block width 5 - 17.5 mm; stretchable 5 - 5.2 mm; plain; snap-on type; green

[www.wago.com/793-5501/000-017](http://www.wago.com/793-5501/000-017)

**Item no.: 793-5501/000-023**

WMB marking card; as card; for terminal block width 5 - 17.5 mm; stretchable 5 - 5.2 mm; plain; snap-on type; light green

[www.wago.com/793-5501/000-023](http://www.wago.com/793-5501/000-023)



**Item no.: 793-5501/000-024**

WMB marking card; as card; for terminal block width 5 - 17.5 mm; stretchable 5 - 5.2 mm; plain; snap-on type; violet

[www.wago.com/793-5501/000-024](http://www.wago.com/793-5501/000-024)

**Protective Warning Marker**

**Item no.: 280-405**

Protective warning marker; with high-voltage symbol, black; for 5 terminal blocks; yellow

[www.wago.com/280-405](http://www.wago.com/280-405)

**Carrier rail**

**Item no.: 210-112**

Steel carrier rail; 35 x 7.5 mm; 1 mm thick; 2 m long; slotted; according to EN 60715; "Hole width 25 mm

[www.wago.com/210-112](http://www.wago.com/210-112)

**Item no.: 210-113**

Steel carrier rail; 35 x 7.5 mm; 1 mm thick; 2 m long; unslotted; according to EN 60715

[www.wago.com/210-113](http://www.wago.com/210-113)

**Item no.: 210-114**

Steel carrier rail; 35 x 15 mm; 1.5 mm thick; 2 m long; unslotted; similar to EN 60715

[www.wago.com/210-114](http://www.wago.com/210-114)



**Item no.: 210-115**

Steel carrier rail; 35 x 7.5 mm; 1 mm thick; 2 m long; slotted; according to EN 60715; "Hole width 18 mm

[www.wago.com/210-115](http://www.wago.com/210-115)



**Item no.: 210-118**

Steel carrier rail; 35 x 15 mm; 2.3 mm thick; 2 m long; unslotted; according to EN 60715

[www.wago.com/210-118](http://www.wago.com/210-118)

**Item no.: 210-196**

Aluminum carrier rail; 35 x 8.2 mm; 1.6 mm thick; 2 m long; unslotted; similar to EN 60715; silver-colored

[www.wago.com/210-196](http://www.wago.com/210-196)



**Item no.: 210-197**

Steel carrier rail; 35 x 15 mm; 1.5 mm thick; 2 m long; slotted; similar to EN 60715

[www.wago.com/210-197](http://www.wago.com/210-197)



**Item no.: 210-198**

Copper carrier rail; 35 x 15 mm; 2.3 mm thick; 2 m long; unslotted; according to EN 60715; copper-colored

[www.wago.com/210-198](http://www.wago.com/210-198)

Subject to changes. Please also observe the further product documentation!

WAGO Kontakttechnik GmbH & Co. KG

Hansastr. 27

32423 Minden









Phone: +49571 887-0 | Fax: +49571 887-169

Email: [info.de@wago.com](mailto:info.de@wago.com) | Web: [www.wago.com](http://www.wago.com)

Do you have any questions about our products?

We are always happy to take your call at +49 (571) 887-44222.



	<b>Item no.: 210-504</b> Steel carrier rail; 35 x 7.5 mm; 1 mm thick; 2 m long; slotted; galvanized; according to EN 60715	<a href="http://www.wago.com/210-504">www.wago.com/210-504</a>
	<b>Item no.: 210-505</b> Steel carrier rail; 35 x 7.5 mm; 1 mm thick; 2 m long; unslotted; galvanized; according to EN 60715	<a href="http://www.wago.com/210-505">www.wago.com/210-505</a>
	<b>Item no.: 210-506</b> Steel carrier rail; 35 x 15 mm; 1.5 mm thick; 2 m long; unslotted; galvanized; similar to EN 60715	<a href="http://www.wago.com/210-506">www.wago.com/210-506</a>
	<b>Item no.: 210-508</b> Steel carrier rail; 35 x 15 mm; 1.5 mm thick; 2 m long; slotted; galvanized; similar to EN 60715	<a href="http://www.wago.com/210-508">www.wago.com/210-508</a>
<b>assembling</b>		
	<b>Item no.: 209-106</b> Mounting carrier; for isolated mounting on DIN 35 rails; gray	<a href="http://www.wago.com/209-106">www.wago.com/209-106</a>
	<b>Item no.: 249-116</b> Screwless end stop; 6 mm wide; for DIN-rail 35 x 15 and 35 x 7.5; gray	<a href="http://www.wago.com/249-116">www.wago.com/249-116</a>
	<b>Item no.: 249-117</b> Screwless end stop; 10 mm wide; for DIN-rail 35 x 15 and 35 x 7.5; gray	<a href="http://www.wago.com/249-117">www.wago.com/249-117</a>
<b>ferrule</b>		
	<b>Item no.: 216-121</b> Ferrule; Sleeve for 0.5 mm <sup>2</sup> / AWG 22; uninsulated; electro-tin plated	<a href="http://www.wago.com/216-121">www.wago.com/216-121</a>
	<b>Item no.: 216-122</b> Ferrule; Sleeve for 0.75 mm <sup>2</sup> / AWG 20; uninsulated; electro-tin plated	<a href="http://www.wago.com/216-122">www.wago.com/216-122</a>
	<b>Item no.: 216-123</b> Ferrule; Sleeve for 1 mm <sup>2</sup> / AWG 18; uninsulated; electro-tin plated	<a href="http://www.wago.com/216-123">www.wago.com/216-123</a>
	<b>Item no.: 216-124</b> Ferrule; Sleeve for 1.5 mm <sup>2</sup> / AWG 16; uninsulated; electro-tin plated	<a href="http://www.wago.com/216-124">www.wago.com/216-124</a>
	<b>Item no.: 216-131</b> Ferrule; Sleeve for 0.25 mm <sup>2</sup> / AWG 24; uninsulated; electro-tin plated	<a href="http://www.wago.com/216-131">www.wago.com/216-131</a>
	<b>Item no.: 216-132</b> Ferrule; Sleeve for 0.34 mm <sup>2</sup> / AWG 24; uninsulated; electro-tin plated	<a href="http://www.wago.com/216-132">www.wago.com/216-132</a>
	<b>Item no.: 216-221</b> Ferrule; Sleeve for 0.5 mm <sup>2</sup> / 20 AWG; insulated; electro-tin plated; white	<a href="http://www.wago.com/216-221">www.wago.com/216-221</a>
	<b>Item no.: 216-222</b> Ferrule; Sleeve for 0.75 mm <sup>2</sup> / 18 AWG; insulated; electro-tin plated; gray	<a href="http://www.wago.com/216-222">www.wago.com/216-222</a>
	<b>Item no.: 216-223</b> Ferrule; Sleeve for 1 mm <sup>2</sup> / AWG 18; insulated; electro-tin plated; red	<a href="http://www.wago.com/216-223">www.wago.com/216-223</a>
	<b>Item no.: 216-224</b> Ferrule; Sleeve for 1.5 mm <sup>2</sup> / AWG 16; insulated; electro-tin plated; black	<a href="http://www.wago.com/216-224">www.wago.com/216-224</a>
	<b>Item no.: 216-321</b>	

Subject to changes. Please also observe the further product documentation!

Ferrule; Sleeve for 0.25 mm<sup>2</sup> / AWG 24; insulated; electro-tin plated; yellow

[www.wago.com/216-321](http://www.wago.com/216-321)

**Item no.: 216-322**

Ferrule; Sleeve for 0.34 mm<sup>2</sup> / 22 AWG; insulated; electro-tin plated; green

[www.wago.com/216-322](http://www.wago.com/216-322)

#### tools



**Item no.: 210-657**

Operating tool; Blade: 3.5 x 0.5 mm; with a partially insulated shaft; short

[www.wago.com/210-657](http://www.wago.com/210-657)

**Item no.: 210-658**

Operating tool; Blade: 3.5 x 0.5 mm; with a partially insulated shaft; angled; short

[www.wago.com/210-658](http://www.wago.com/210-658)



**Item no.: 210-720**

Operating tool; Blade: 3.5 x 0.5 mm; with a partially insulated shaft

[www.wago.com/210-720](http://www.wago.com/210-720)

## Downloads

### Documentation

#### Additional Information

Technical explanations

Apr 3, 2019

pdf  
2.1 MB

[Download](#)

### CAD/CAE-Data

#### CAD data

2D/3D Models 870-590/281-410

[URL](#)

[Download](#)

#### CAE data

EPLAN Data Portal 870-590/281-410

[URL](#)

[Download](#)

WSCAD Universe 870-590/281-410

[URL](#)

[Download](#)

### Installation Notes

Subject to changes. Please also observe the further product documentation!

WAGO Kontakttechnik GmbH & Co. KG

Hansastr. 27

32423 Minden

Phone: +49571 887-0 | Fax: +49571 887-169

Email: [info.de@wago.com](mailto:info.de@wago.com) | Web: [www.wago.com](http://www.wago.com)

Do you have any questions about our products?

We are always happy to take your call at +49 (571) 887-44222.