

## Data sheet | Item number: 870-556

Triple-deck terminal block; 6-conductor through terminal block; L; internal commoning; conductor entry with violet marking; for DIN-rail 35 x 15 and 35 x 7.5; 2.5 mm<sup>2</sup>; CAGE CLAMP®; 2,50 mm<sup>2</sup>; gray

[www.wago.com/870-556](http://www.wago.com/870-556)

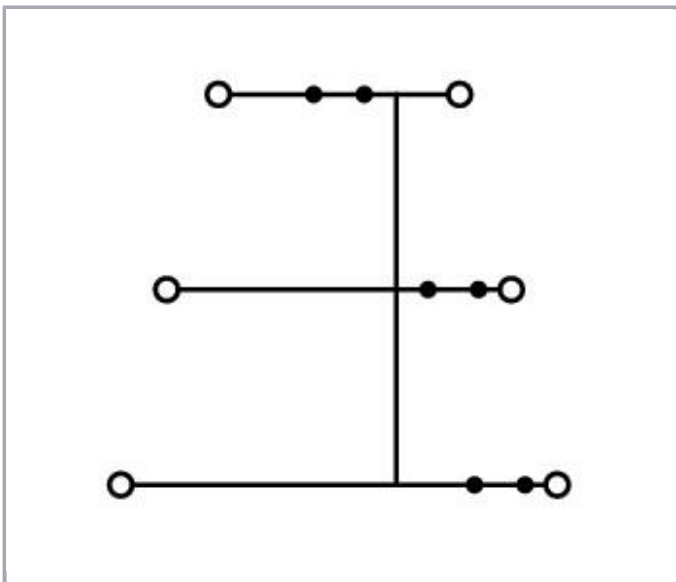
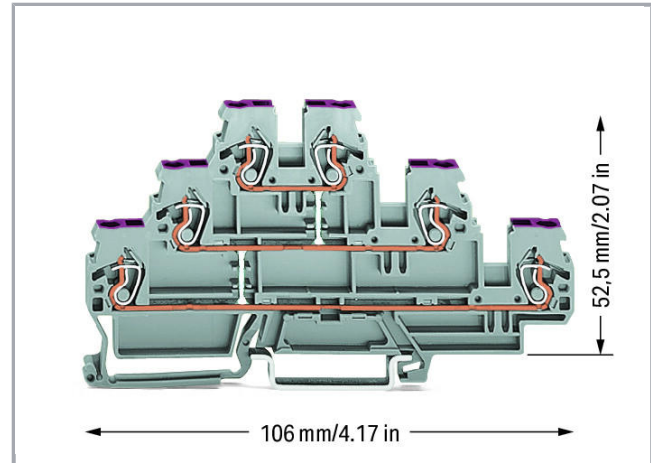
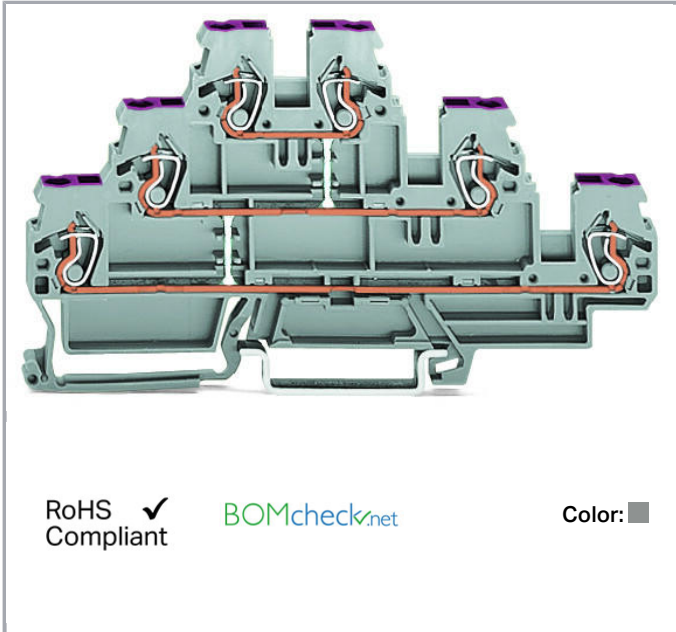

### Item description

#### Safety information 1:

Max. insulation diameter: 4.4 mm

Subject to changes. Please also observe the further product documentation!

WAGO Kontakttechnik GmbH & Co. KG  
Hansastr. 27  
32423 Minden  
Phone: +49571 887-0 | Fax: +49571 887-169  
Email: [info.de@wago.com](mailto:info.de@wago.com) | Web: [www.wago.com](http://www.wago.com)

Do you have any questions about our products?  
We are always happy to take your call at +49 (571) 887-44222.



## Data

### Electrical data

#### Ratings per IEC/EN 60664-1

|                                 |   |
|---------------------------------|---|
| Ratings per                     | IEC/EN 60947-7-1  |
| Rated voltage (III / 3)         | 500 V   |
| Rated impulse voltage (III / 3) | 6 kV  |
| Rated current                   | 24 A  |
| Legend (ratings)                | (III / 3) $\hat{=}$ Overvoltage category III / Pollution degree 3 |

### Connection data

|                                   |  |
|-----------------------------------|--|
| Connection technology             | CAGE CLAMP <sup>®</sup>                      |
| Actuation type                    | Operating tool                               |
| Connectable conductor materials   | Copper                                       |
| Solid conductor                   | 0,08 ... 2,5 mm <sup>2</sup> / 28 ... 12 AWG |
| Fine-stranded conductor           | 0,08 ... 4 mm <sup>2</sup> / 28 ... 12 AWG   |
| Strip length                      | 6 ... 7 mm / 0.24 ... 0.28 inch              |
| Total number of connection points | 6  |
| Total number of potentials        | 1  |
| Number of levels                  | 3  |
| Type of wiring                    | Front-entry wiring                           |

### Geometrical Data

|                                       |                      |
|---------------------------------------|----------------------|
| Width                                 | 5 mm / 0.197 inch    |
| Height from upper-edge of DIN-35 rail | 52,5 mm / 2.067 inch |
| Depth                                 | 106 mm / 4.173 inch  |

### Mechanical data

|                   |              |
|-------------------|--------------|
| Design            | horizontal   |
| Type of mounting  | DIN-35 rail  |
| Potential marking | L            |
| Marking level     | Side marking |

Subject to changes. Please also observe the further product documentation!

WAGO Kontakttechnik GmbH & Co. KG  
 Hansastr. 27  
 32423 Minden  
 Phone: +49571 887-0 | Fax: +49571 887-169  
 Email: [info.de@wago.com](mailto:info.de@wago.com) | Web: [www.wago.com](http://www.wago.com)

Do you have any questions about our products?  
 We are always happy to take your call at +49 (571) 887-44222.

## Material Data

|           |         |
|-----------|---------|
| Color     | gray    |
| Fire load | 0.28 MJ |
| Weight    | 17.8 g  |

## Commercial data



|                    |               |
|--------------------|---------------|
| Packaging type     | BOX           |
| Country of origin  | DE            |
| GTIN               | 4045454129705 |
| Customs Tariff No. | 85369010000   |

## Approvals / Certificates

### Country specific Approvals

| Logo   | Approval                        | Additional Approval Text | Certificate name |
|--|---------------------------------|--------------------------|------------------|
|   | CCA<br>DEKRA Certification B.V. | EN 60947                 | NTR NL<br>7468   |
|  | CCA<br>DEKRA Certification B.V. | EN 60947                 | 2189801.01       |

### Ship Approvals

| Logo  | Approval   | Additional Approval Text | Certificate name         |
|---|--|--------------------------|--------------------------|
|   | ABS<br>American Bureau of Shipping               | -                        | 20-<br>HG1941090-<br>PDA |
|   | DNV GL<br>Det Norske Veritas, Germanischer Lloyd | -                        | TAE00001V2               |
|  | LR<br>Lloyds Register                            | EN 60947                 | 91/20112<br>(E9)         |

Subject to changes. Please also observe the further product documentation!



## UL-Approvals

| Logo   | Approval                               | Additional Approval Text | Certificate name    |
|--|--|--------------------------|---------------------|
|  | cURus<br>UL International Germany GmbH | UL 1059                  | 20160928-<br>E45172 |

## Counterpart

## Compatible products

## Carrier rail

|  |  |  |
|--|--|--|
|  | <b>Item no.: 210-112</b><br>Steel carrier rail; 35 x 7.5 mm; 1 mm thick; 2 m long; slotted; according to EN 60715; "Hole width 25 mm   | <a href="http://www.wago.com/210-112">www.wago.com/210-112</a> |
|  | <b>Item no.: 210-113</b><br>Steel carrier rail; 35 x 7.5 mm; 1 mm thick; 2 m long; unslotted; according to EN 60715                    | <a href="http://www.wago.com/210-113">www.wago.com/210-113</a> |
|  | <b>Item no.: 210-114</b><br>Steel carrier rail; 35 x 15 mm; 1.5 mm thick; 2 m long; unslotted; similar to EN 60715                     | <a href="http://www.wago.com/210-114">www.wago.com/210-114</a> |
|  | <b>Item no.: 210-115</b><br>Steel carrier rail; 35 x 7.5 mm; 1 mm thick; 2 m long; slotted; according to EN 60715; "Hole width 18 mm   | <a href="http://www.wago.com/210-115">www.wago.com/210-115</a> |
|  | <b>Item no.: 210-118</b><br>Steel carrier rail; 35 x 15 mm; 2.3 mm thick; 2 m long; unslotted; according to EN 60715                   | <a href="http://www.wago.com/210-118">www.wago.com/210-118</a> |
|  | <b>Item no.: 210-196</b><br>Aluminum carrier rail; 35 x 8.2 mm; 1.6 mm thick; 2 m long; unslotted; similar to EN 60715; silver-colored | <a href="http://www.wago.com/210-196">www.wago.com/210-196</a> |
|  | <b>Item no.: 210-197</b><br>Steel carrier rail; 35 x 15 mm; 1.5 mm thick; 2 m long; slotted; similar to EN 60715                       | <a href="http://www.wago.com/210-197">www.wago.com/210-197</a> |
|  | <b>Item no.: 210-504</b><br>Steel carrier rail; 35 x 7.5 mm; 1 mm thick; 2 m long; slotted; galvanized; according to EN 60715          | <a href="http://www.wago.com/210-504">www.wago.com/210-504</a> |

Subject to changes. Please also observe the further product documentation!

WAGO Kontakttechnik GmbH & Co. KG  
 Hansastr. 27  
 32423 Minden  
 Phone: +49571 887-0 | Fax: +49571 887-169  
 Email: [info.de@wago.com](mailto:info.de@wago.com) | Web: [www.wago.com](http://www.wago.com)

Do you have any questions about our products?  
 We are always happy to take your call at +49 (571) 887-44222.



**Item no.: 210-505**  
Steel carrier rail; 35 x 7.5 mm; 1 mm thick; 2 m long; unslotted; galvanized; according to EN 60715

[www.wago.com/210-505](http://www.wago.com/210-505)

**Item no.: 210-506**  
Steel carrier rail; 35 x 15 mm; 1.5 mm thick; 2 m long; unslotted; galvanized; similar to EN 60715

[www.wago.com/210-506](http://www.wago.com/210-506)



**Item no.: 210-508**  
Steel carrier rail; 35 x 15 mm; 1.5 mm thick; 2 m long; slotted; galvanized; similar to EN 60715

[www.wago.com/210-508](http://www.wago.com/210-508)

**tools**

**Item no.: 210-657**  
Operating tool; Blade: 3.5 x 0.5 mm; with a partially insulated shaft; short

[www.wago.com/210-657](http://www.wago.com/210-657)



**Item no.: 210-658**  
Operating tool; Blade: 3.5 x 0.5 mm; with a partially insulated shaft; angled; short

[www.wago.com/210-658](http://www.wago.com/210-658)



**Item no.: 210-720**  
Operating tool; Blade: 3.5 x 0.5 mm; with a partially insulated shaft

[www.wago.com/210-720](http://www.wago.com/210-720)

**End plate**



**Item no.: 870-568**  
End and intermediate plate; 2 mm thick; gray

[www.wago.com/870-568](http://www.wago.com/870-568)



**Item no.: 870-569**  
End and intermediate plate; 2 mm thick; orange

[www.wago.com/870-569](http://www.wago.com/870-569)

**Protective Warning Marker**



**Item no.: 280-405**  
Protective warning marker; with high-voltage symbol, black; for 5 terminal blocks; yellow

[www.wago.com/280-405](http://www.wago.com/280-405)

**Insulation stop**

**Item no.: 280-470**  
Insulation stop; 0.08 - 0.2 mm<sup>2</sup> "s" (0.14 mm<sup>2</sup> "f-st"); 5 pieces/strip; white

[www.wago.com/280-470](http://www.wago.com/280-470)

**Item no.: 280-471**  
Insulation stop; 0.25 - 0.5 mm<sup>2</sup>; 5 pieces/strip; light gray

[www.wago.com/280-471](http://www.wago.com/280-471)

**Item no.: 280-472**  
Insulation stop; 0.75 - 1 mm<sup>2</sup>; 5 pieces/strip

[www.wago.com/280-472](http://www.wago.com/280-472)

**ferrule**

**Item no.: 216-121**  
Ferrule; Sleeve for 0.5 mm<sup>2</sup> / AWG 22; uninsulated; electro-tin plated

[www.wago.com/216-121](http://www.wago.com/216-121)

**Item no.: 216-122**  
Ferrule; Sleeve for 0.75 mm<sup>2</sup> / AWG 20; uninsulated; electro-tin plated

[www.wago.com/216-122](http://www.wago.com/216-122)









**Item no.: 216-123**  
Ferrule; Sleeve for 1 mm<sup>2</sup> / AWG 18; uninsulated; electro-tin plated

[www.wago.com/216-123](http://www.wago.com/216-123)



**Item no.: 216-124**  
Ferrule; Sleeve for 1.5 mm<sup>2</sup> / AWG 16; uninsulated; electro-tin plated

[www.wago.com/216-124](http://www.wago.com/216-124)

Subject to changes. Please also observe the further product documentation!

|  |  |  |
|--|--|--|
|  | <b>Item no.: 216-131</b><br>Ferrule; Sleeve for 0.25 mm <sup>2</sup> / AWG 24; uninsulated; electro-tin plated                               | <a href="http://www.wago.com/216-131">www.wago.com/216-131</a>                   |
|     | <b>Item no.: 216-132</b><br>Ferrule; Sleeve for 0.34 mm <sup>2</sup> / AWG 24; uninsulated; electro-tin plated                               | <a href="http://www.wago.com/216-132">www.wago.com/216-132</a>                   |
|  | <b>Item no.: 216-221</b><br>Ferrule; Sleeve for 0.5 mm <sup>2</sup> / 20 AWG; insulated; electro-tin plated; white                           | <a href="http://www.wago.com/216-221">www.wago.com/216-221</a>                   |
|     | <b>Item no.: 216-222</b><br>Ferrule; Sleeve for 0.75 mm <sup>2</sup> / 18 AWG; insulated; electro-tin plated; gray                           | <a href="http://www.wago.com/216-222">www.wago.com/216-222</a>                   |
|     | <b>Item no.: 216-223</b><br>Ferrule; Sleeve for 1 mm <sup>2</sup> / AWG 18; insulated; electro-tin plated; red                               | <a href="http://www.wago.com/216-223">www.wago.com/216-223</a>                   |
|  | <b>Item no.: 216-224</b><br>Ferrule; Sleeve for 1.5 mm <sup>2</sup> / AWG 16; insulated; electro-tin plated; black                           | <a href="http://www.wago.com/216-224">www.wago.com/216-224</a>                   |
|  | <b>Item no.: 216-321</b><br>Ferrule; Sleeve for 0.25 mm <sup>2</sup> / AWG 24; insulated; electro-tin plated; yellow                         | <a href="http://www.wago.com/216-321">www.wago.com/216-321</a>                   |
|     | <b>Item no.: 216-322</b><br>Ferrule; Sleeve for 0.34 mm <sup>2</sup> / 22 AWG; insulated; electro-tin plated; green                          | <a href="http://www.wago.com/216-322">www.wago.com/216-322</a>                   |
| <b>Marking accessories</b>   |  |  |
|    | <b>Item no.: 2009-115</b><br>WMB-Inline; for Smart Printer; 1500 pieces on roll; stretchable 5 - 5.2 mm; plain; snap-on type; white          | <a href="http://www.wago.com/2009-115">www.wago.com/2009-115</a>                 |
|  | <b>Item no.: 2009-115/000-002</b><br>WMB-Inline; for Smart Printer; 1500 pieces on roll; stretchable 5 - 5.2 mm; plain; snap-on type; yellow | <a href="http://www.wago.com/2009-115/000-002">www.wago.com/2009-115/000-002</a> |
|  | <b>Item no.: 2009-115/000-006</b><br>WMB-Inline; for Smart Printer; 1500 pieces on roll; stretchable 5 - 5.2 mm; plain; snap-on type; white  | <a href="http://www.wago.com/2009-115/000-006">www.wago.com/2009-115/000-006</a> |
|  | <b>Item no.: 2009-115/000-007</b><br>WMB-Inline; for Smart Printer; 1500 pieces on roll; stretchable 5 - 5.2 mm; plain; snap-on type; gray   | <a href="http://www.wago.com/2009-115/000-007">www.wago.com/2009-115/000-007</a> |
|  | <b>Item no.: 2009-115/000-012</b><br>WMB-Inline; for Smart Printer; 1500 pieces on roll; stretchable 5 - 5.2 mm; plain; snap-on type; white  | <a href="http://www.wago.com/2009-115/000-012">www.wago.com/2009-115/000-012</a> |
|  | <b>Item no.: 2009-115/000-017</b><br>WMB-Inline; for Smart Printer; 1500 pieces on roll; stretchable 5 - 5.2 mm; plain; snap-on type; white  | <a href="http://www.wago.com/2009-115/000-017">www.wago.com/2009-115/000-017</a> |
|  | <b>Item no.: 2009-115/000-023</b><br>WMB-Inline; for Smart Printer; 1500 pieces on roll; stretchable 5 - 5.2 mm; plain; snap-on type; green  | <a href="http://www.wago.com/2009-115/000-023">www.wago.com/2009-115/000-023</a> |

Subject to changes. Please also observe the further product documentation!

|  |   |   |
|--|---|---|
|  | <p><b>Item no.: 2009-115/000-024</b><br/>WMB-Inline; for Smart Printer; 1500 pieces on roll; stretchable 5 - 5.2 mm; plain; snap-on type; white</p>       | <p><a href="http://www.wago.com/2009-115/000-024">www.wago.com/2009-115/000-024</a></p> |
| /  | <p><b>Item no.: 2009-145</b><br/>Mini-WSB Inline; for Smart Printer; 1700 pieces on roll; stretchable 5 - 5.2 mm; plain; snap-on type; white</p>          | <p><a href="http://www.wago.com/2009-145">www.wago.com/2009-145</a></p>                 |
| /  | <p><b>Item no.: 2009-145/000-002</b><br/>Mini-WSB Inline; for Smart Printer; 1700 pieces on roll; stretchable 5 - 5.2 mm; plain; snap-on type; white</p>  | <p><a href="http://www.wago.com/2009-145/000-002">www.wago.com/2009-145/000-002</a></p> |
|  | <p><b>Item no.: 2009-145/000-005</b><br/>Mini-WSB Inline; for Smart Printer; 1700 pieces on roll; stretchable 5 - 5.2 mm; plain; snap-on type; red</p>    | <p><a href="http://www.wago.com/2009-145/000-005">www.wago.com/2009-145/000-005</a></p> |
| /  | <p><b>Item no.: 2009-145/000-006</b><br/>Mini-WSB Inline; for Smart Printer; 1700 pieces on roll; stretchable 5 - 5.2 mm; plain; snap-on type; blue</p>   | <p><a href="http://www.wago.com/2009-145/000-006">www.wago.com/2009-145/000-006</a></p> |
| /  | <p><b>Item no.: 2009-145/000-007</b><br/>Mini-WSB Inline; for Smart Printer; 1700 pieces on roll; stretchable 5 - 5.2 mm; plain; snap-on type; white</p>  | <p><a href="http://www.wago.com/2009-145/000-007">www.wago.com/2009-145/000-007</a></p> |
| /  | <p><b>Item no.: 2009-145/000-012</b><br/>Mini-WSB Inline; for Smart Printer; 1700 pieces on roll; stretchable 5 - 5.2 mm; plain; snap-on type; orange</p> | <p><a href="http://www.wago.com/2009-145/000-012">www.wago.com/2009-145/000-012</a></p> |
|  | <p><b>Item no.: 2009-145/000-023</b><br/>Mini-WSB Inline; for Smart Printer; 1700 pieces on roll; stretchable 5 - 5.2 mm; plain; snap-on type; green</p>  | <p><a href="http://www.wago.com/2009-145/000-023">www.wago.com/2009-145/000-023</a></p> |
|  | <p><b>Item no.: 2009-145/000-024</b><br/>Mini-WSB Inline; for Smart Printer; 1700 pieces on roll; stretchable 5 - 5.2 mm; plain; snap-on type; violet</p> | <p><a href="http://www.wago.com/2009-145/000-024">www.wago.com/2009-145/000-024</a></p> |
|  | <p><b>Item no.: 248-501</b><br/>Miniature WSB Quick marking system; plain; Marker width 5 mm; 10 strips with 10 markers per card</p>                      | <p><a href="http://www.wago.com/248-501">www.wago.com/248-501</a></p>                   |
|  | <p><b>Item no.: 248-501/000-002</b><br/>Mini-WSB marking card; as card; not stretchable; plain; snap-on type; yellow</p>                                  | <p><a href="http://www.wago.com/248-501/000-002">www.wago.com/248-501/000-002</a></p>   |
|  | <p><b>Item no.: 248-501/000-005</b><br/>Mini-WSB marking card; as card; not stretchable; plain; snap-on type; red</p>                                     | <p><a href="http://www.wago.com/248-501/000-005">www.wago.com/248-501/000-005</a></p>   |
|  | <p><b>Item no.: 248-501/000-006</b><br/>Mini-WSB marking card; as card; not stretchable; plain; snap-on type; blue</p>                                    | <p><a href="http://www.wago.com/248-501/000-006">www.wago.com/248-501/000-006</a></p>   |
|  | <p><b>Item no.: 248-501/000-007</b><br/>Mini-WSB marking card; as card; not stretchable; plain; snap-on type; gray</p>                                    | <p><a href="http://www.wago.com/248-501/000-007">www.wago.com/248-501/000-007</a></p>   |

Subject to changes. Please also observe the further product documentation!



**Item no.: 248-501/000-012**  
Mini-WSB marking card; as card; not stretchable; plain; snap-on type; orange

[www.wago.com/248-501/000-012](http://www.wago.com/248-501/000-012)



**Item no.: 248-501/000-017**  
Mini-WSB marking card; as card; not stretchable; plain; snap-on type; light green

[www.wago.com/248-501/000-017](http://www.wago.com/248-501/000-017)



**Item no.: 248-501/000-023**  
Mini-WSB marking card; as card; not stretchable; plain; snap-on type; green

[www.wago.com/248-501/000-023](http://www.wago.com/248-501/000-023)



**Item no.: 248-501/000-024**  
Mini-WSB marking card; as card; not stretchable; plain; snap-on type; violet

[www.wago.com/248-501/000-024](http://www.wago.com/248-501/000-024)



**Item no.: 709-177**  
Marking strips; on reel; 7.5 mm wide; not stretchable; plain; snap-on type; translucent

[www.wago.com/709-177](http://www.wago.com/709-177)

**Item no.: 709-178**  
Marking strips; on reel; 7.5 mm wide; not stretchable; plain; snap-on type; white

[www.wago.com/709-178](http://www.wago.com/709-178)



**Item no.: 709-196**  
Marking strips; for laser printer; translucent

[www.wago.com/709-196](http://www.wago.com/709-196)

**Item no.: 709-198**  
Marking strips; white

[www.wago.com/709-198](http://www.wago.com/709-198)

**Item no.: 793-501**  
WMB marking card; as card; not stretchable; plain; snap-on type; white

[www.wago.com/793-501](http://www.wago.com/793-501)



**Item no.: 793-501/000-002**  
WMB marking card; as card; not stretchable; plain; snap-on type; yellow

[www.wago.com/793-501/000-002](http://www.wago.com/793-501/000-002)



**Item no.: 793-501/000-005**  
WMB marking card; as card; not stretchable; plain; snap-on type; red

[www.wago.com/793-501/000-005](http://www.wago.com/793-501/000-005)



**Item no.: 793-501/000-006**  
WMB marking card; as card; not stretchable; plain; snap-on type; blue

[www.wago.com/793-501/000-006](http://www.wago.com/793-501/000-006)

**Item no.: 793-501/000-007**  
WMB marking card; as card; not stretchable; plain; snap-on type; gray

[www.wago.com/793-501/000-007](http://www.wago.com/793-501/000-007)

**Item no.: 793-501/000-012**  
WMB marking card; as card; not stretchable; plain; snap-on type; orange

[www.wago.com/793-501/000-012](http://www.wago.com/793-501/000-012)









**Item no.: 793-501/000-017**  
WMB marking card; as card; not stretchable; plain; snap-on type; light green

[www.wago.com/793-501/000-017](http://www.wago.com/793-501/000-017)

Subject to changes. Please also observe the further product documentation!



|  |  |  |
|--|--|--|
|  | <b>Item no.: 793-501/000-023</b><br>WMB marking card; as card; not stretchable; plain; snap-on type; green   | <a href="http://www.wago.com/793-501/000-023">www.wago.com/793-501/000-023</a>   |
|  | <b>Item no.: 793-501/000-024</b><br>WMB marking card; as card; not stretchable; plain; snap-on type; violet  | <a href="http://www.wago.com/793-501/000-024">www.wago.com/793-501/000-024</a>   |
|  | <b>Item no.: 793-5501</b><br>WMB marking card; as card; for terminal block width 5 - 17.5 mm; stretchable 5 - 5.2 mm; plain; snap-on type; white               | <a href="http://www.wago.com/793-5501">www.wago.com/793-5501</a>                 |
|  | <b>Item no.: 793-5501/000-002</b><br>WMB marking card; as card; for terminal block width 5 - 17.5 mm; stretchable 5 - 5.2 mm; plain; snap-on type; yellow      | <a href="http://www.wago.com/793-5501/000-002">www.wago.com/793-5501/000-002</a> |
|    | <b>Item no.: 793-5501/000-005</b><br>WMB marking card; as card; for terminal block width 5 - 17.5 mm; stretchable 5 - 5.2 mm; plain; snap-on type; red         | <a href="http://www.wago.com/793-5501/000-005">www.wago.com/793-5501/000-005</a> |
|  | <b>Item no.: 793-5501/000-006</b><br>WMB marking card; as card; for terminal block width 5 - 17.5 mm; stretchable 5 - 5.2 mm; plain; snap-on type; blue        | <a href="http://www.wago.com/793-5501/000-006">www.wago.com/793-5501/000-006</a> |
|  | <b>Item no.: 793-5501/000-007</b><br>WMB marking card; as card; for terminal block width 5 - 17.5 mm; stretchable 5 - 5.2 mm; plain; snap-on type; gray        | <a href="http://www.wago.com/793-5501/000-007">www.wago.com/793-5501/000-007</a> |
|  | <b>Item no.: 793-5501/000-012</b><br>WMB marking card; as card; for terminal block width 5 - 17.5 mm; stretchable 5 - 5.2 mm; plain; snap-on type; orange      | <a href="http://www.wago.com/793-5501/000-012">www.wago.com/793-5501/000-012</a> |
|  | <b>Item no.: 793-5501/000-017</b><br>WMB marking card; as card; for terminal block width 5 - 17.5 mm; stretchable 5 - 5.2 mm; plain; snap-on type; green       | <a href="http://www.wago.com/793-5501/000-017">www.wago.com/793-5501/000-017</a> |
|  | <b>Item no.: 793-5501/000-023</b><br>WMB marking card; as card; for terminal block width 5 - 17.5 mm; stretchable 5 - 5.2 mm; plain; snap-on type; light green | <a href="http://www.wago.com/793-5501/000-023">www.wago.com/793-5501/000-023</a> |
|  | <b>Item no.: 793-5501/000-024</b><br>WMB marking card; as card; for terminal block width 5 - 17.5 mm; stretchable 5 - 5.2 mm; plain; snap-on type; violet      | <a href="http://www.wago.com/793-5501/000-024">www.wago.com/793-5501/000-024</a> |
| <b>assembling</b>  |  |  |
|  | <b>Item no.: 209-106</b><br>Mounting carrier; for isolated mounting on DIN 35 rails; gray  | <a href="http://www.wago.com/209-106">www.wago.com/209-106</a>                   |
|  | <b>Item no.: 249-116</b><br>Screwless end stop; 6 mm wide; for DIN-rail 35 x 15 and 35 x 7.5; gray   | <a href="http://www.wago.com/249-116">www.wago.com/249-116</a>                   |
|  | <b>Item no.: 249-117</b><br>Screwless end stop; 10 mm wide; for DIN-rail 35 x 15 and 35 x 7.5; gray  | <a href="http://www.wago.com/249-117">www.wago.com/249-117</a>                   |

Subject to changes. Please also observe the further product documentation!

---

**Jumper**

---

**Item no.: 709-110**

Wire commoning chain; insulated; 4 connections; 3 x 110 mm; black

[www.wago.com/709-110](http://www.wago.com/709-110)**Item no.: 709-111**

Wire commoning chain; insulated; 3 connections; 2 x 120 mm; black

[www.wago.com/709-111](http://www.wago.com/709-111)**Item no.: 709-112**

Wire commoning chain; insulated; 3 connections; 2 x 170 mm; black

[www.wago.com/709-112](http://www.wago.com/709-112)**Item no.: 870-402**

Push-in type jumper bar; insulated; 2-way; Nominal current 18 A; light gray

[www.wago.com/870-402](http://www.wago.com/870-402)**Item no.: 870-403**

Push-in type jumper bar; insulated; 3-way; Nominal current 18 A; light gray

[www.wago.com/870-403](http://www.wago.com/870-403)**Item no.: 870-404**

Push-in type jumper bar; insulated; 4-way; Nominal current 18 A; light gray

[www.wago.com/870-404](http://www.wago.com/870-404)**Item no.: 870-405**

Push-in type jumper bar; insulated; 5-way; Nominal current 18 A; light gray

[www.wago.com/870-405](http://www.wago.com/870-405)**Item no.: 870-405/011-000**

Ready-made push-in type jumper bar; insulated; 3-way (1-3-5); Nominal current 18 A; light gray

[www.wago.com/870-405/011-000](http://www.wago.com/870-405/011-000)**Item no.: 870-406**

Push-in type jumper bar; insulated; 6-way; Nominal current 18 A; light gray

[www.wago.com/870-406](http://www.wago.com/870-406)**Item no.: 870-407**

Push-in type jumper bar; insulated; 7-way; Nominal current 18 A; light gray

[www.wago.com/870-407](http://www.wago.com/870-407)**Item no.: 870-407/011-000**

Ready-made push-in type jumper bar; insulated; 1-3-5-7; Nominal current 18 A; light gray

[www.wago.com/870-407/011-000](http://www.wago.com/870-407/011-000)**Item no.: 870-408**

Push-in type jumper bar; insulated; 8-way; Nominal current 18 A; light gray

[www.wago.com/870-408](http://www.wago.com/870-408)**Item no.: 870-409**

Push-in type jumper bar; insulated; 9-way; Nominal current 18 A; light gray

[www.wago.com/870-409](http://www.wago.com/870-409)**Item no.: 870-409/011-000**

Ready-made push-in type jumper bar; insulated; 1-3-5-7-9; Nominal current 18 A; light gray

[www.wago.com/870-409/011-000](http://www.wago.com/870-409/011-000)**Item no.: 870-410**

Push-in type jumper bar; insulated; 10-way; Nominal current 18 A; light gray

[www.wago.com/870-410](http://www.wago.com/870-410)**Item no.: 870-433**

Push-in type jumper bar; insulated; from 1 to 3; Nominal current 18 A; light gray

[www.wago.com/870-433](http://www.wago.com/870-433)

---

 Subject to changes. Please also observe the further product documentation!

WAGO Kontakttechnik GmbH &amp; Co. KG

Hansastr. 27







32423 Minden

Phone: +49571 887-0 | Fax: +49571 887-169







Email: [info.de@wago.com](mailto:info.de@wago.com) | Web: [www.wago.com](http://www.wago.com)

Do you have any questions about our products?

We are always happy to take your call at +49 (571) 887-44222.

|  |  |  |
|--|--|--|
|  | <b>Item no.: 870-434</b><br>Push-in type jumper bar; insulated; from 1 to 4; Nominal current 18 A; light gray  | <a href="http://www.wago.com/870-434">www.wago.com/870-434</a> |
|  | <b>Item no.: 870-435</b><br>Push-in type jumper bar; insulated; from 1 to 5; Nominal current 18 A; light gray  | <a href="http://www.wago.com/870-435">www.wago.com/870-435</a> |
|  | <b>Item no.: 870-436</b><br>Push-in type jumper bar; insulated; from 1 to 6; Nominal current 18 A; light gray  | <a href="http://www.wago.com/870-436">www.wago.com/870-436</a> |
|  | <b>Item no.: 870-437</b><br>Push-in type jumper bar; insulated; from 1 to 7; Nominal current 18 A; light gray  | <a href="http://www.wago.com/870-437">www.wago.com/870-437</a> |
|  | <b>Item no.: 870-438</b><br>Push-in type jumper bar; insulated; from 1 to 8; Nominal current 18 A; light gray  | <a href="http://www.wago.com/870-438">www.wago.com/870-438</a> |
|  | <b>Item no.: 870-439</b><br>Push-in type jumper bar; insulated; from 1 to 9; Nominal current 18 A; light gray  | <a href="http://www.wago.com/870-439">www.wago.com/870-439</a> |
|  | <b>Item no.: 870-440</b><br>Push-in type jumper bar; insulated; from 1 to 10; Nominal current 18 A; light gray | <a href="http://www.wago.com/870-440">www.wago.com/870-440</a> |

**General accessories**

|  |  |  |
|--|--|--|
|    | <b>Item no.: 870-182</b><br>Adaptor; gray  | <a href="http://www.wago.com/870-182">www.wago.com/870-182</a> |
|    | <b>Item no.: 870-183</b><br>Adaptor; gray  | <a href="http://www.wago.com/870-183">www.wago.com/870-183</a> |
|  | <b>Item no.: 870-184</b><br>Adaptor; gray  | <a href="http://www.wago.com/870-184">www.wago.com/870-184</a> |
|  | <b>Item no.: 870-425</b><br>Tap-off module; with anti-rotation protection; modular; suitable for 870 Series terminal blocks with jumper slots in the current bar; gray | <a href="http://www.wago.com/870-425">www.wago.com/870-425</a> |
|  | <b>Item no.: 870-426</b><br>Tap-off module; modular; suitable for 870 Series terminal blocks with jumper slots in the current bar; gray                                | <a href="http://www.wago.com/870-426">www.wago.com/870-426</a> |
|  | <b>Item no.: 870-427</b><br>Spacer module; modular; bridging commoned terminal blocks; gray  | <a href="http://www.wago.com/870-427">www.wago.com/870-427</a> |

**Downloads**

**Documentation**

**Additional Information**

|                        |             |               |          |
|------------------------|-------------|---------------|----------|
| Technical explanations | Apr 3, 2019 | pdf<br>2.1 MB | Download |
|------------------------|-------------|---------------|----------|

Subject to changes. Please also observe the further product documentation!

## CAD/CAE-Data

### CAD data

|                      |                     |                          |
|----------------------|---------------------|--------------------------|
| 2D/3D Models 870-556 | <a href="#">URL</a> | <a href="#">Download</a> |
|----------------------|---------------------|--------------------------|

### CAE data

|                           |                     |                          |
|---------------------------|---------------------|--------------------------|
| EPLAN Data Portal 870-556 | <a href="#">URL</a> | <a href="#">Download</a> |
|---------------------------|---------------------|--------------------------|

|                        |                     |                          |
|------------------------|---------------------|--------------------------|
| WSCAD Universe 870-556 | <a href="#">URL</a> | <a href="#">Download</a> |
|------------------------|---------------------|--------------------------|

## Installation Notes

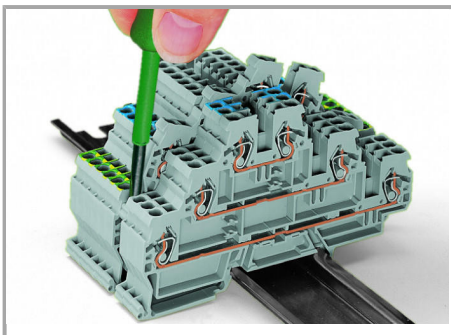

Removing a terminal block from the assembly.

Subject to changes. Please also observe the further product documentation!

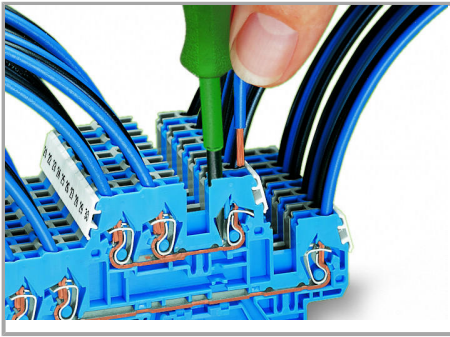

CAGE CLAMP® connection

Inserting a conductor (0.08 ... 4 mm<sup>2</sup> "f-st").

### Jumpered



Push jumper bars down firmly until fully inserted. When using multipole bars, push alternately on the right and then left side, until installed.

Push-in type jumper bars 1 – 3 – 5 – 7 or  
1 – – 4 – – 7

upon request

### Testing



Commoning with push-in type jumper bars:

Two parallel jumper slots are  
accommodated in one terminal block.

Subject to changes. Please also observe the further product documentation!

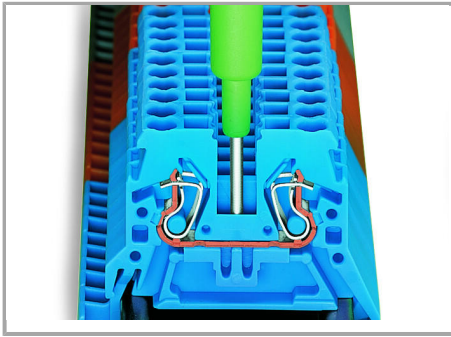

Testing with phase testing device, also possible with single-pole voltage tester.

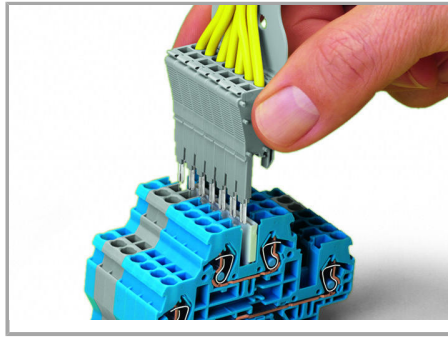

Testing is also possible using a pre-wired tap-off module assembly in the very same way as test plugs.

### Cover

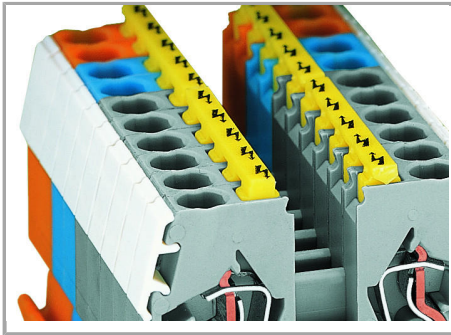

Protective warning markers (280-405), with a black high-voltage symbol

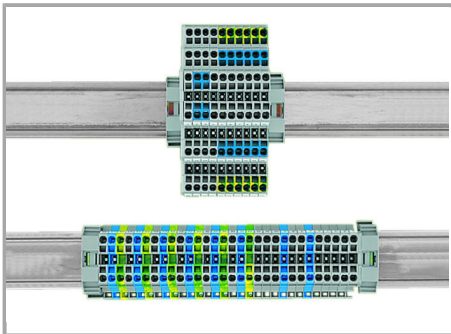

Use 67 % less rail space with triple-deck terminal blocks.

### Marking

Subject to changes. Please also observe the further product documentation!

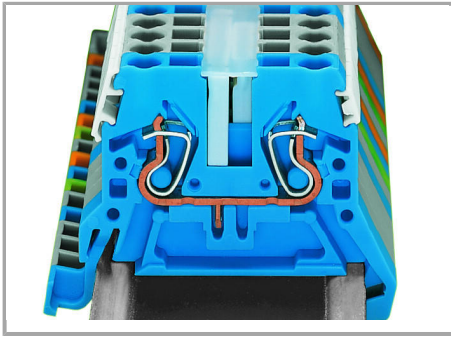

WMB markers in Mini-WSB marker slots

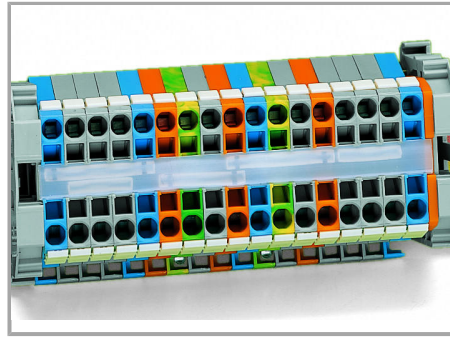

Translucent marking strip (709-196) – jumper bars below may be visible.

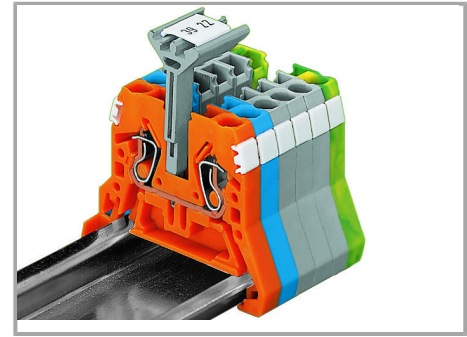

In addition to the plastic marker strips, group marker carriers are now available for the WMB and WSB marking systems. They can be mounted parallel to a push-in type jumper bar via open jumper contact slot. It assists with viewing marker slots on the side of the terminal block. Group marker carriers are available in 5 mm/0.197 inch, 10 mm/0.394 inch and 15 mm/0.591 inch widths.

Marking strip, translucent

Mini-WSB markers

**Notice:**

Marker carriers are not suitable for ground conductor terminal blocks and double-potential terminal blocks as they have no jumper contact slots.

Subject to changes. Please also observe the further product documentation!