

**Data sheet | Item number: 859-732**

Optocoupler module; Nominal input voltage: 24 VDC; Output voltage range: 3 ... 30 VDC; Limiting continuous current: 0.5 A; 1 changeover contact; Red status indicator; Module width: 6 mm

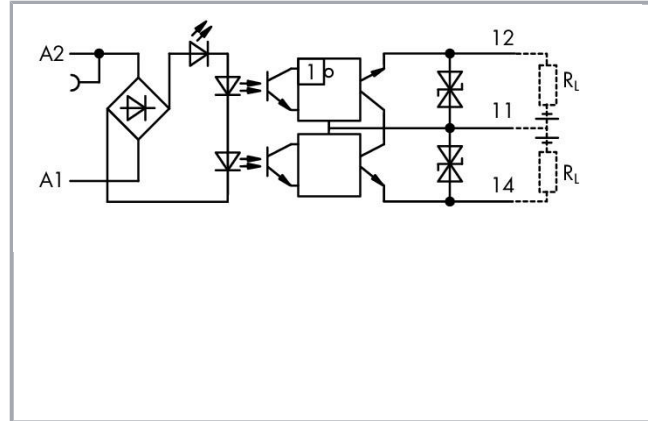

[www.wago.com/859-732](http://www.wago.com/859-732)

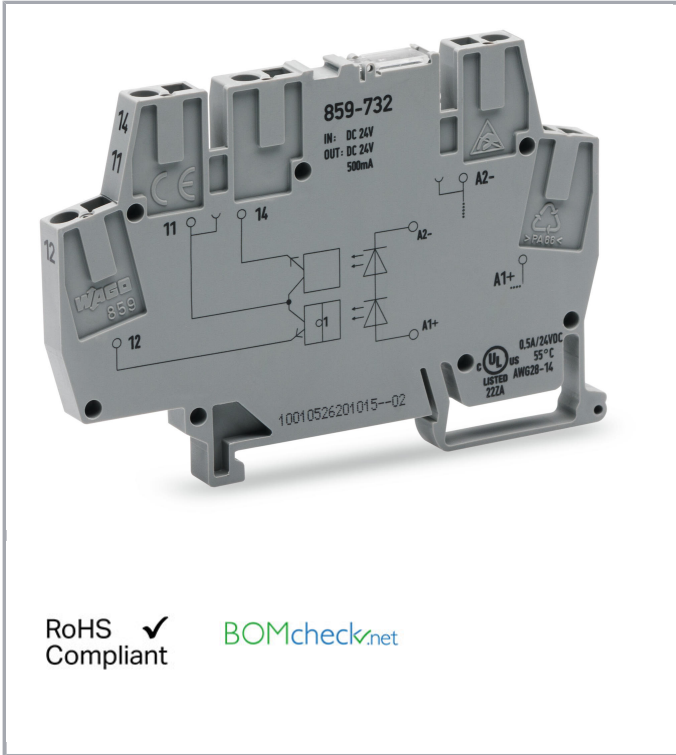

RoHS  Compliant [BOMcheck.net](http://BOMcheck.net)

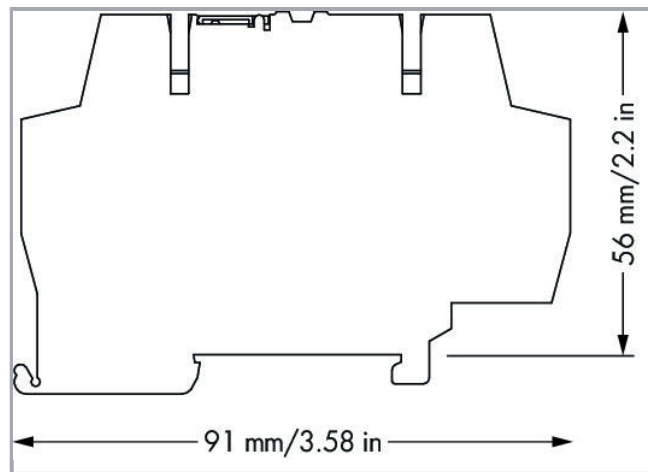
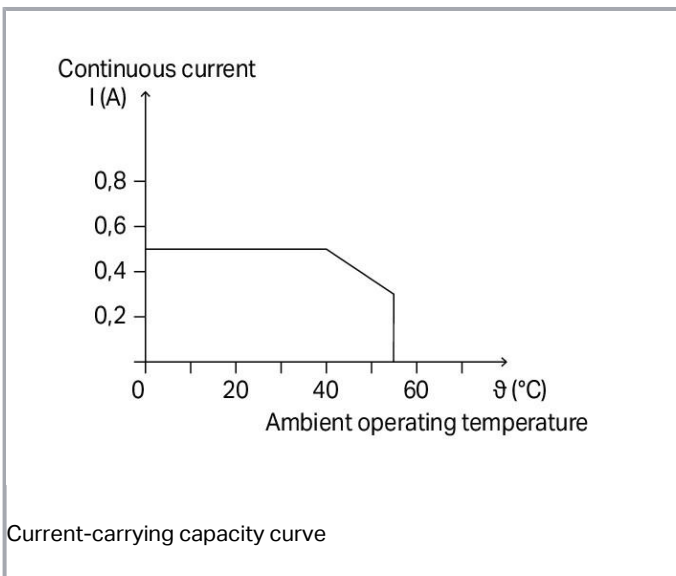

Subject to changes. Please also observe the further product documentation!

WAGO Kontakttechnik GmbH & Co. KG  
 Hansastr. 27  
 32423 Minden  
 Phone: +49571 887-0 | Fax: +49571 887-169  
 Email: [info.de@wago.com](mailto:info.de@wago.com) | Web: [www.wago.com](http://www.wago.com)

Do you have any questions about our products?  
 We are always happy to take your call at +49 (571) 887-44222.

## Item description

### Note:

Optocouplers and solid state relays are designed for use in signal processing networks, which are not supplied by the low-voltage power supply networks.

## Data

### Technical Data

#### Control circuit

|                                  |                |
|----------------------------------|----------------|
| Nominal input voltage $U_N$      | DC 24 V        |
| Input voltage range (low level)  | DC 0 ... 5 V   |
| Input voltage range (high level) | DC 15 ... 42 V |
| Nominal input current at $U_N$   | 5,3 mA         |

#### Load circuit:

|                             |  |
|-----------------------------|--|
| Circuit type                | 3-wire connection<br>Changeover contact output |
| Limiting continuous current | 0,5 A  |
| Peak output current         | 4 A  |
| Nominal output voltage      | DC 24 V  |
| Output voltage range        | DC 3 ... 30 V                                  |
| Max. voltage drop at output | ≤ DC 1,5 V                                     |
| Turn-on time                | ≤ 25 μs  |
| Drop-out time               | ≤ 150 μs                                       |
| Switching frequency         | ≤ 1,5 kHz                                      |

#### Signaling

|                   |         |
|-------------------|---------|
| Status indication | Red LED |
|-------------------|---------|

#### Safety and protection:

|   |            |
|---|------------|
| Rated voltage   | 300 V      |
| Overvoltage category                                  | II         |
| Pollution degree                                      | 2          |
| Dielectric strength, control/load circuit (AC, 1 min) | 3,51 kVrms |

Subject to changes. Please also observe the further product documentation!



|  |  |
|--|--|
| Insulation type (control/load circuit) | Basic insulation                       |
| Insulation type (adjacent devices)     | Reinforced insulation (safe isolation) |

### Connection data

|                         |  |
|-------------------------|--|
| Connection technology   | CAGE CLAMP®                                  |
| Solid conductor         | 0,08 ... 2,5 mm <sup>2</sup> / 28 ... 14 AWG |
| Fine-stranded conductor | 0,08 ... 2,5 mm <sup>2</sup> / 28 ... 14 AWG |
| Strip length            | 5 ... 6 mm / 0.2 ... 0.24 inch               |

### Geometrical Data

|                                       |                    |
|---------------------------------------|--------------------|
| Width                                 | 6 mm / 0.236 inch  |
| Height from upper-edge of DIN-35 rail | 56 mm / 2.205 inch |
| Depth                                 | 91 mm / 3.583 inch |

### Mechanical data

|                  |             |
|------------------|-------------|
| Type of mounting | DIN-35 rail |
|------------------|-------------|

### Material Data

|           |          |
|-----------|----------|
| Fire load | 0.313 MJ |
| Weight    | 19.6 g   |

### Environmental Requirements

|   |                |
|---|----------------|
| Surrounding air (operating) temperature at U <sub>N</sub> | -25 ... 55 °C  |
| Surrounding air (storage) temperature                     | -25 ... 70 °C  |
| Processing temperature                                    | -25 ... +50 °C |

### Standards and specifications

|                          |  |
|--------------------------|--|
| Standards/specifications | EN 60664-1; EN 61000-6-2; EN 61000-6-3; UL 508 |
|--------------------------|--|

### Commercial data

|                    |                           |
|--------------------|---------------------------|
| Product Group      | 6 (Interface Electronics) |
| Packaging type     | BOX                       |
| Country of origin  | DE                        |
| GTIN               | 4055143605038             |
| Customs Tariff No. | 85365005000               |

Subject to changes. Please also observe the further product documentation!

WAGO Kontakttechnik GmbH & Co. KG  
 Hansastr. 27  
 32423 Minden  
 Phone: +49571 887-0 | Fax: +49571 887-169  
 Email: [info.de@wago.com](mailto:info.de@wago.com) | Web: [www.wago.com](http://www.wago.com)

Do you have any questions about our products?  
 We are always happy to take your call at +49 (571) 887-44222.

## Approvals / Certificates

### UL-Approvals

| Logo   | Approval   | Additional Approval Text | Certificate name |
|--|--|--------------------------|------------------|
|  | UL<br>UL International Netherlands B.V. (ORDINARY LOCATIONS) | UL 508                   | E175199<br>Sec.4 |

### Counterpart

### Compatible products

#### End plate

|  |  |
|--|--|
| <b>Item no.: 859-525</b><br>End and intermediate plate; 1 mm thick; gray | <a href="http://www.wago.com/859-525">www.wago.com/859-525</a> |
|--|--|





#### Test Accessories

|   |  |
|---|--|
|  <b>Item no.: 859-500</b><br>Test pin; 1 mm Ø; with solder connection for test wire | <a href="http://www.wago.com/859-500">www.wago.com/859-500</a> |
|---|--|

#### tools

|   |  |
|---|--|
| <b>Item no.: 210-720</b><br>Operating tool; Blade: 3.5 x 0.5 mm; with a partially insulated shaft | <a href="http://www.wago.com/210-720">www.wago.com/210-720</a> |
|---|--|













#### Marking accessories

|  |  |
|--|--|
|  <b>Item no.: 2009-145</b><br>Mini-WSB Inline; for Smart Printer; 1700 pieces on roll; stretchable 5 - 5.2 mm; plain; snap-on type; white                  | <a href="http://www.wago.com/2009-145">www.wago.com/2009-145</a> |
|  <b>Item no.: 2009-145/000-002</b><br>Mini-WSB Inline; for Smart Printer; 1700 pieces on roll; stretchable 5 - 5.2 mm; plain; snap-on type; white /000-002 | <a href="http://www.wago.com/2009-145">www.wago.com/2009-145</a> |
|  <b>Item no.: 2009-145/000-005</b><br>Mini-WSB Inline; for Smart Printer; 1700 pieces on roll; stretchable 5 - 5.2 mm; plain; snap-on type; red /000-005   | <a href="http://www.wago.com/2009-145">www.wago.com/2009-145</a> |
|  <b>Item no.: 2009-145/000-006</b><br>Mini-WSB Inline; for Smart Printer; 1700 pieces on roll; stretchable 5 - 5.2 mm; plain; snap-on type; blue /000-006  | <a href="http://www.wago.com/2009-145">www.wago.com/2009-145</a> |















Subject to changes. Please also observe the further product documentation!

WAGO Kontakttechnik GmbH & Co. KG  
Hansastr. 27  
32423 Minden  
Phone: +49571 887-0 | Fax: +49571 887-169  
Email: [info.de@wago.com](mailto:info.de@wago.com) | Web: [www.wago.com](http://www.wago.com)















Do you have any questions about our products?  
We are always happy to take your call at +49 (571) 887-44222.

|  |   |  |
|--|---|--|
|    | <b>Item no.: 2009-145/000-007</b><br>Mini-WSB Inline; for Smart Printer; 1700 pieces on roll; stretchable 5 - 5.2 mm; plain; snap-on type; white /000-007 | <a href="http://www.wago.com/2009-145/000-007">www.wago.com/2009-145/000-007</a> |
|    | <b>Item no.: 2009-145/000-012</b><br>Mini-WSB Inline; for Smart Printer; 1700 pieces on roll; stretchable 5 - 5.2 mm; plain; snap-on type; orange         | <a href="http://www.wago.com/2009-145/000-012">www.wago.com/2009-145/000-012</a> |
|    | <b>Item no.: 2009-145/000-023</b><br>Mini-WSB Inline; for Smart Printer; 1700 pieces on roll; stretchable 5 - 5.2 mm; plain; snap-on type; green          | <a href="http://www.wago.com/2009-145/000-023">www.wago.com/2009-145/000-023</a> |
|    | <b>Item no.: 2009-145/000-024</b><br>Mini-WSB Inline; for Smart Printer; 1700 pieces on roll; stretchable 5 - 5.2 mm; plain; snap-on type; violet         | <a href="http://www.wago.com/2009-145/000-024">www.wago.com/2009-145/000-024</a> |
|    | <b>Item no.: 210-110</b><br>Fiber-tip pen   | <a href="http://www.wago.com/210-110">www.wago.com/210-110</a>                   |
|    | <b>Item no.: 248-501</b><br>Miniature WSB Quick marking system; plain; Marker width 5 mm; 10 strips with 10 markers per card                              | <a href="http://www.wago.com/248-501">www.wago.com/248-501</a>                   |
|    | <b>Item no.: 248-501/000-002</b><br>Mini-WSB marking card; as card; not stretchable; plain; snap-on type; yellow  | <a href="http://www.wago.com/248-501/000-002">www.wago.com/248-501/000-002</a>   |
|  | <b>Item no.: 248-501/000-005</b><br>Mini-WSB marking card; as card; not stretchable; plain; snap-on type; red   | <a href="http://www.wago.com/248-501/000-005">www.wago.com/248-501/000-005</a>   |
|  | <b>Item no.: 248-501/000-006</b><br>Mini-WSB marking card; as card; not stretchable; plain; snap-on type; blue  | <a href="http://www.wago.com/248-501/000-006">www.wago.com/248-501/000-006</a>   |
|  | <b>Item no.: 248-501/000-007</b><br>Mini-WSB marking card; as card; not stretchable; plain; snap-on type; gray  | <a href="http://www.wago.com/248-501/000-007">www.wago.com/248-501/000-007</a>   |
|  | <b>Item no.: 248-501/000-012</b><br>Mini-WSB marking card; as card; not stretchable; plain; snap-on type; orange  | <a href="http://www.wago.com/248-501/000-012">www.wago.com/248-501/000-012</a>   |
|  | <b>Item no.: 248-501/000-017</b><br>Mini-WSB marking card; as card; not stretchable; plain; snap-on type; light green                                     | <a href="http://www.wago.com/248-501/000-017">www.wago.com/248-501/000-017</a>   |
|  | <b>Item no.: 248-501/000-023</b><br>Mini-WSB marking card; as card; not stretchable; plain; snap-on type; green   | <a href="http://www.wago.com/248-501/000-023">www.wago.com/248-501/000-023</a>   |
|  | <b>Item no.: 248-501/000-024</b><br>Mini-WSB marking card; as card; not stretchable; plain; snap-on type; violet  | <a href="http://www.wago.com/248-501/000-024">www.wago.com/248-501/000-024</a>   |













Subject to changes. Please also observe the further product documentation!

|  |  |  |
|--|--|--|
|    | <b>Item no.: 248-502</b><br>Mini-WSB marking card; as card; MARKED; 1 ... 10 (10x); not stretchable; Horizontal marking; snap-on type; white           | <a href="http://www.wago.com/248-502">www.wago.com/248-502</a>                 |
|    | <b>Item no.: 248-502/000-024</b><br>Mini-WSB marking card; as card; MARKED; 1 ... 10 (10x); not stretchable; Horizontal marking; snap-on type; violet  | <a href="http://www.wago.com/248-502/000-024">www.wago.com/248-502/000-024</a> |
|    | <b>Item no.: 248-503</b><br>Mini-WSB marking card; as card; MARKED; 11 ... 20 (10x); not stretchable; Horizontal marking; snap-on type; white          | <a href="http://www.wago.com/248-503">www.wago.com/248-503</a>                 |
|    | <b>Item no.: 248-503/000-024</b><br>Mini-WSB marking card; as card; MARKED; 11 ... 20 (10x); not stretchable; Horizontal marking; snap-on type; violet | <a href="http://www.wago.com/248-503/000-024">www.wago.com/248-503/000-024</a> |
|    | <b>Item no.: 248-504</b><br>Mini-WSB marking card; as card; MARKED; 21 ... 30 (10x); not stretchable; Horizontal marking; snap-on type; white          | <a href="http://www.wago.com/248-504">www.wago.com/248-504</a>                 |
|    | <b>Item no.: 248-504/000-024</b><br>Mini-WSB marking card; as card; MARKED; 21 ... 30 (10x); not stretchable; Horizontal marking; snap-on type; violet | <a href="http://www.wago.com/248-504/000-024">www.wago.com/248-504/000-024</a> |
|    | <b>Item no.: 248-505/000-024</b><br>Mini-WSB marking card; as card; MARKED; 31 ... 40 (10x); not stretchable; Horizontal marking; snap-on type; violet | <a href="http://www.wago.com/248-505/000-024">www.wago.com/248-505/000-024</a> |
|  | <b>Item no.: 248-506</b><br>Mini-WSB marking card; as card; MARKED; 41 ... 50 (10x); not stretchable; Horizontal marking; snap-on type; white          | <a href="http://www.wago.com/248-506">www.wago.com/248-506</a>                 |
| <b>Jumper</b>  |  |  |
|  | <b>Item no.: 859-402</b><br>Push-in type jumper bar; 2-way; Nominal current 18 A; insulated; light gray  | <a href="http://www.wago.com/859-402">www.wago.com/859-402</a>                 |
|  | <b>Item no.: 859-402/000-005</b><br>Push-in type jumper bar; 2-way; Nominal current 18 A; insulated; red   | <a href="http://www.wago.com/859-402/000-005">www.wago.com/859-402/000-005</a> |
|  | <b>Item no.: 859-402/000-006</b><br>Push-in type jumper bar; 2-way; Nominal current 18 A; insulated; blue  | <a href="http://www.wago.com/859-402/000-006">www.wago.com/859-402/000-006</a> |
|  | <b>Item no.: 859-402/000-029</b><br>Push-in type jumper bar; 2-way; Nominal current 18 A; insulated; yellow  | <a href="http://www.wago.com/859-402/000-029">www.wago.com/859-402/000-029</a> |
|  | <b>Item no.: 859-403</b><br>Push-in type jumper bar; 3-way; Nominal current 18 A; insulated; light gray  | <a href="http://www.wago.com/859-403">www.wago.com/859-403</a>                 |
|  | <b>Item no.: 859-403/000-005</b><br>Push-in type jumper bar; 3-way; Nominal current 18 A; insulated; red   | <a href="http://www.wago.com/859-403/000-005">www.wago.com/859-403/000-005</a> |

Subject to changes. Please also observe the further product documentation!

|  |   |  |
|--|---|--|
|    | <b>Item no.: 859-403/000-006</b><br>Push-in type jumper bar; 3-way; Nominal current 18 A; insulated; blue   | <a href="http://www.wago.com/859-403/000-006">www.wago.com/859-403/000-006</a> |
|    | <b>Item no.: 859-403/000-029</b><br>Push-in type jumper bar; 3-way; Nominal current 18 A; insulated; yellow | <a href="http://www.wago.com/859-403/000-029">www.wago.com/859-403/000-029</a> |
|    | <b>Item no.: 859-404</b><br>Push-in type jumper bar; 4-way; Nominal current 18 A; insulated; light gray     | <a href="http://www.wago.com/859-404">www.wago.com/859-404</a>                 |
|    | <b>Item no.: 859-404/000-005</b><br>Push-in type jumper bar; 4-way; Nominal current 18 A; insulated; red    | <a href="http://www.wago.com/859-404/000-005">www.wago.com/859-404/000-005</a> |
|    | <b>Item no.: 859-404/000-006</b><br>Push-in type jumper bar; 4-way; Nominal current 18 A; insulated; blue   | <a href="http://www.wago.com/859-404/000-006">www.wago.com/859-404/000-006</a> |
|    | <b>Item no.: 859-404/000-029</b><br>Push-in type jumper bar; 4-way; Nominal current 18 A; insulated; yellow | <a href="http://www.wago.com/859-404/000-029">www.wago.com/859-404/000-029</a> |
|    | <b>Item no.: 859-405</b><br>Push-in type jumper bar; 5-way; Nominal current 18 A; insulated; light gray     | <a href="http://www.wago.com/859-405">www.wago.com/859-405</a>                 |
|   | <b>Item no.: 859-405/000-005</b><br>Push-in type jumper bar; 5-way; Nominal current 18 A; insulated; red    | <a href="http://www.wago.com/859-405/000-005">www.wago.com/859-405/000-005</a> |
|  | <b>Item no.: 859-405/000-006</b><br>Push-in type jumper bar; 5-way; Nominal current 18 A; insulated; blue   | <a href="http://www.wago.com/859-405/000-006">www.wago.com/859-405/000-006</a> |
|  | <b>Item no.: 859-405/000-029</b><br>Push-in type jumper bar; 5-way; Nominal current 18 A; insulated; yellow | <a href="http://www.wago.com/859-405/000-029">www.wago.com/859-405/000-029</a> |
|  | <b>Item no.: 859-406</b><br>Push-in type jumper bar; 6-way; Nominal current 18 A; insulated; light gray     | <a href="http://www.wago.com/859-406">www.wago.com/859-406</a>                 |
|  | <b>Item no.: 859-406/000-005</b><br>Push-in type jumper bar; 6-way; Nominal current 18 A; insulated; red    | <a href="http://www.wago.com/859-406/000-005">www.wago.com/859-406/000-005</a> |
|  | <b>Item no.: 859-406/000-006</b><br>Push-in type jumper bar; 6-way; Nominal current 18 A; insulated; blue   | <a href="http://www.wago.com/859-406/000-006">www.wago.com/859-406/000-006</a> |
|  | <b>Item no.: 859-406/000-029</b><br>Push-in type jumper bar; 6-way; Nominal current 18 A; insulated; yellow | <a href="http://www.wago.com/859-406/000-029">www.wago.com/859-406/000-029</a> |

Subject to changes. Please also observe the further product documentation!

|  |   |  |
|--|---|--|
|    | <b>Item no.: 859-407</b><br>Push-in type jumper bar; 7-way; Nominal current 18 A; insulated; light gray     | <a href="http://www.wago.com/859-407">www.wago.com/859-407</a>                 |
|    | <b>Item no.: 859-407/000-005</b><br>Push-in type jumper bar; 7-way; Nominal current 18 A; insulated; red    | <a href="http://www.wago.com/859-407/000-005">www.wago.com/859-407/000-005</a> |
|    | <b>Item no.: 859-407/000-006</b><br>Push-in type jumper bar; 7-way; Nominal current 18 A; insulated; blue   | <a href="http://www.wago.com/859-407/000-006">www.wago.com/859-407/000-006</a> |
|    | <b>Item no.: 859-407/000-029</b><br>Push-in type jumper bar; 7-way; Nominal current 18 A; insulated; yellow | <a href="http://www.wago.com/859-407/000-029">www.wago.com/859-407/000-029</a> |
|    | <b>Item no.: 859-408</b><br>Push-in type jumper bar; 8-way; Nominal current 18 A; insulated; light gray     | <a href="http://www.wago.com/859-408">www.wago.com/859-408</a>                 |
|    | <b>Item no.: 859-408/000-005</b><br>Push-in type jumper bar; 8-way; Nominal current 18 A; insulated; red    | <a href="http://www.wago.com/859-408/000-005">www.wago.com/859-408/000-005</a> |
|    | <b>Item no.: 859-408/000-006</b><br>Push-in type jumper bar; 8-way; Nominal current 18 A; insulated; blue   | <a href="http://www.wago.com/859-408/000-006">www.wago.com/859-408/000-006</a> |
|   | <b>Item no.: 859-408/000-029</b><br>Push-in type jumper bar; 8-way; Nominal current 18 A; insulated; yellow | <a href="http://www.wago.com/859-408/000-029">www.wago.com/859-408/000-029</a> |
|  | <b>Item no.: 859-409</b><br>Push-in type jumper bar; 9-way; Nominal current 18 A; insulated; light gray     | <a href="http://www.wago.com/859-409">www.wago.com/859-409</a>                 |
|  | <b>Item no.: 859-409/000-005</b><br>Push-in type jumper bar; 9-way; Nominal current 18 A; insulated; red    | <a href="http://www.wago.com/859-409/000-005">www.wago.com/859-409/000-005</a> |
|  | <b>Item no.: 859-409/000-006</b><br>Push-in type jumper bar; 9-way; Nominal current 18 A; insulated; blue   | <a href="http://www.wago.com/859-409/000-006">www.wago.com/859-409/000-006</a> |
|  | <b>Item no.: 859-409/000-029</b><br>Push-in type jumper bar; 9-way; Nominal current 18 A; insulated; yellow | <a href="http://www.wago.com/859-409/000-029">www.wago.com/859-409/000-029</a> |
|  | <b>Item no.: 859-410</b><br>Push-in type jumper bar; 10-way; Nominal current 18 A; insulated; light gray    | <a href="http://www.wago.com/859-410">www.wago.com/859-410</a>                 |
|  | <b>Item no.: 859-410/000-005</b><br>Push-in type jumper bar; 10-way; Nominal current 18 A; insulated; red   | <a href="http://www.wago.com/859-410/000-005">www.wago.com/859-410/000-005</a> |

Subject to changes. Please also observe the further product documentation!



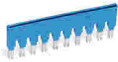

**Item no.: 859-410/000-006**  
Push-in type jumper bar; 10-way; Nominal current 18 A; insulated; blue

[www.wago.com/859-410/000-006](http://www.wago.com/859-410/000-006)



**Item no.: 859-410/000-029**  
Push-in type jumper bar; 10-way; Nominal current 18 A; insulated; yellow

[www.wago.com/859-410/000-029](http://www.wago.com/859-410/000-029)

**ferrule**

**Item no.: 216-221**  
Ferrule; Sleeve for 0.5 mm<sup>2</sup> / 20 AWG; insulated; electro-tin plated; white

[www.wago.com/216-221](http://www.wago.com/216-221)



**Item no.: 216-222**  
Ferrule; Sleeve for 0.75 mm<sup>2</sup> / 18 AWG; insulated; electro-tin plated; gray

[www.wago.com/216-222](http://www.wago.com/216-222)



**Item no.: 216-223**  
Ferrule; Sleeve for 1 mm<sup>2</sup> / AWG 18; insulated; electro-tin plated; red

[www.wago.com/216-223](http://www.wago.com/216-223)



**Item no.: 216-224**  
Ferrule; Sleeve for 1.5 mm<sup>2</sup> / AWG 16; insulated; electro-tin plated; black

[www.wago.com/216-224](http://www.wago.com/216-224)

**Item no.: 216-321**  
Ferrule; Sleeve for 0.25 mm<sup>2</sup> / AWG 24; insulated; electro-tin plated; yellow

[www.wago.com/216-321](http://www.wago.com/216-321)



**Item no.: 216-322**  
Ferrule; Sleeve for 0.34 mm<sup>2</sup> / 22 AWG; insulated; electro-tin plated; green

[www.wago.com/216-322](http://www.wago.com/216-322)

**Downloads**

**Documentation**

**Instruction Leaflet**

|                                    |                         |               |          |
|------------------------------------|-------------------------|---------------|----------|
| Relay modules, Optocoupler modules | V 1.2.0<br>Aug 30, 2019 | pdf<br>2.2 MB | Download |
|------------------------------------|-------------------------|---------------|----------|

**Additional Information**

|  |         |                 |          |
|--|---------|-----------------|----------|
| Disposal; Electrical and electronic equipment, Packaging | V 1.0.0 | pdf<br>265.8 kB | Download |
|--|---------|-----------------|----------|

**CAD/CAE-Data**

**CAD data**

|                      |     |          |
|----------------------|-----|----------|
| 2D/3D Models 859-732 | URL | Download |
|----------------------|-----|----------|

**CAE data**

EPLAN Data Portal 859-732

Subject to changes. Please also observe the further product documentation!

WAGO Kontakttechnik GmbH & Co. KG  
Hansastr. 27  
32423 Minden  
Phone: +49571 887-0 | Fax: +49571 887-169  
Email: [info.de@wago.com](mailto:info.de@wago.com) | Web: [www.wago.com](http://www.wago.com)

Do you have any questions about our products?  
We are always happy to take your call at +49 (571) 887-44222.

## Installation Notes

### Inserting a conductor

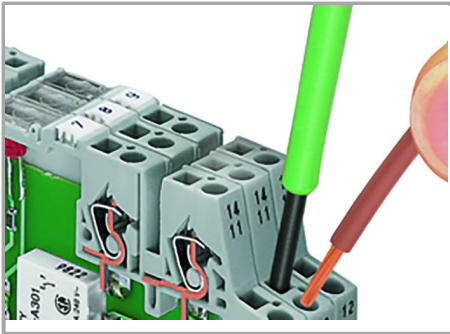

Connection of conductor

### Jumpered

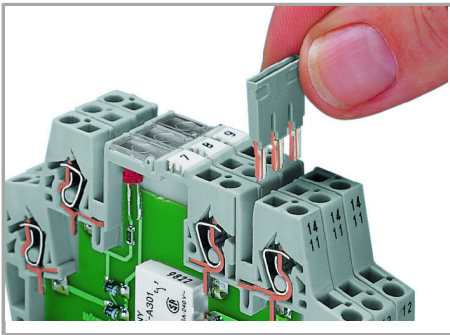

Easy commoning using adjacent jumpers

### Marking

Subject to changes. Please also observe the further product documentation!



Marking using miniature WSB quick marking card

Subject to changes. Please also observe the further product documentation!