

Data sheet | Item number: 858-392

Relay module; Nominal input voltage: 110 VDC; 4 changeover contacts;
 Limiting continuous current: 6 A; with manual operation; Red status indicator;
 Module width: 31 mm; 1,50 mm²

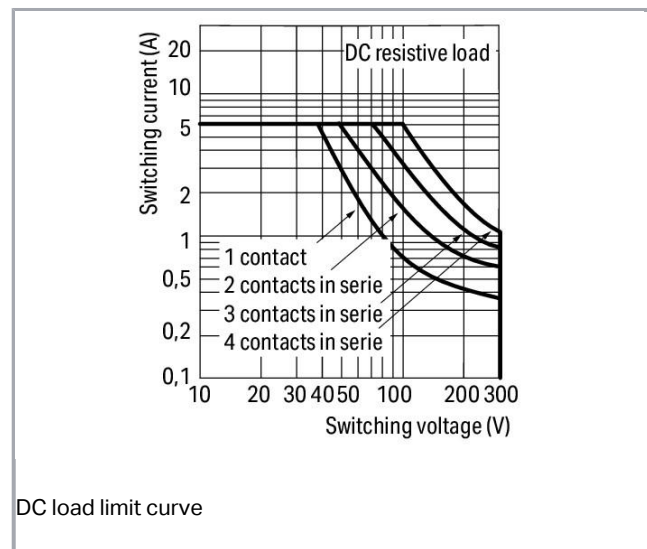

www.wago.com/858-392

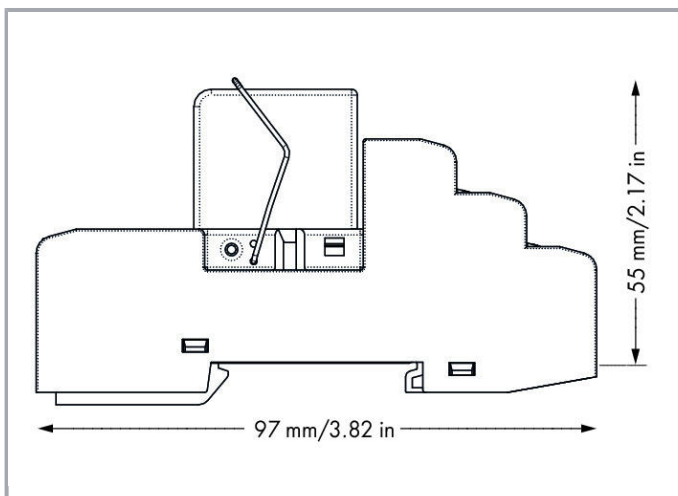
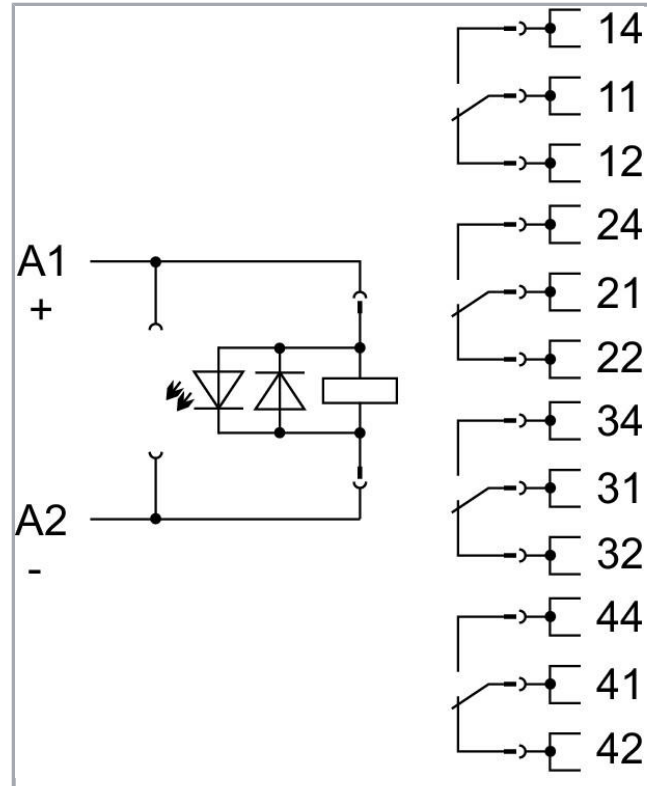
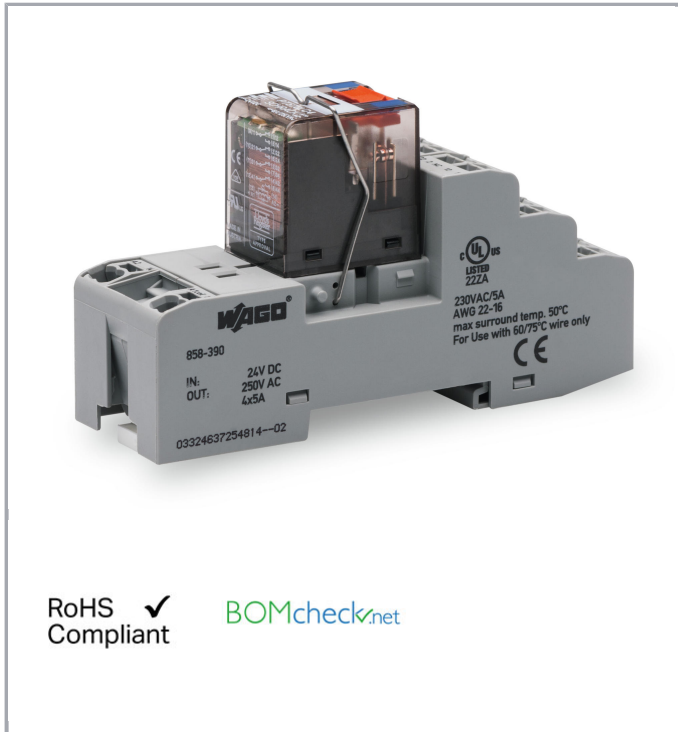

Subject to changes. Please also observe the further product documentation!

WAGO Kontakttechnik GmbH & Co. KG
 Hansastr. 27
 32423 Minden
 Phone: +49571 887-0 | Fax: +49571 887-169
 Email: info.de@wago.com | Web: www.wago.com

Do you have any questions about our products?
 We are always happy to take your call at +49 (571) 887-44222.



Data

Technical Data

Control circuit

| | |
|--------------------------------|---------------|
| Nominal input voltage U_N | DC 110 V |
| Input voltage range | -10 ... +30 % |
| Nominal input current at U_N | 7.7 mA |

Load circuit:

| | |
|---|--|
| Number of changeover/switchover contacts | 4 |
| Contact material (relay) | AgNi 90/10 |
| Limiting continuous current | 6 A |
| Max. make current (resistive) | (AC) 12 A / 0.02 s |
| Max. switching voltage | AC 250 V |
| Max. switching power (resistive) | AC 1500 VA; DC see load limit curve |
| Recommended minimum load | 12 V / 10 mA |
| Pull-in time (typ.) | 15 ms |
| Drop-out time (typ.) | 18 ms |
| Bounce time (typ.) | 8 ms |
| Electrical life (N.O.; resistive load; 23 °C) | 100 x 10 ³ switching operations |
| Mechanical life | 30 x 10 ⁶ switching operations |
| Max. switching load with load/without load | 6 min ⁻¹ / 60 min ⁻¹ |

Signaling

| | |
|-------------------|-----------------------|
| Status indication | LED red Mechanical |
|-------------------|-----------------------|

Safety and protection:

| | |
|---|-----------|
| Rated voltage | 250 V |
| Rated impulse voltage | 2.5 kV |
| Pollution degree | 2 |
| Dielectric strength, control/load circuit (AC, 1 min) | 2.5 kVrms |
| Dielectric strength open contact (AC, 1 min) | 1.2 kVrms |
| Dielectric strength, load/load circuit (AC, 1 min) | 2 kVrms |
| Protection class | IP20 |

Subject to changes. Please also observe the further product documentation!

WAGO Kontakttechnik GmbH & Co. KG
 Hansastr. 27
 32423 Minden
 Phone: +49571 887-0 | Fax: +49571 887-169
 Email: info.de@wago.com | Web: www.wago.com

Do you have any questions about our products?
 We are always happy to take your call at +49 (571) 887-44222.



Connection data

| | |
|--------------------------------|--|
| Connection technology | Push-in CAGE CLAMP® |
| Solid conductor | 0.34 ... 1.5 mm ² / 22 ... 16 AWG |
| Fine-stranded conductor | 0.34 ... 1.5 mm ² / 22 ... 16 AWG |
| Strip length | 9 ... 10 mm / 0.35 ... 0.39 inch |
| Note (conductor cross-section) | 2 x 0.34 ... 2 x 1.5 mm ² / 1 x 2.5 mm ² / 2 x 22 ... 2 x 16 AWG |

Geometrical Data

| | |
|---------------------------------------|--------------------|
| Width | 31 mm / 1.22 inch |
| Height from upper-edge of DIN-35 rail | 55 mm / 2.165 inch |
| Depth | 97 mm / 3.819 inch |

Mechanical data

| | |
|------------------|-------------|
| Type of mounting | DIN-35 rail |
|------------------|-------------|

Material Data

| | |
|-----------|----------|
| Fire load | 1.091 MJ |
| Weight | 89.4 g |

Environmental Requirements

| | |
|---|----------------|
| Surrounding air (operating) temperature at U _N | -40 ... 70 °C |
| Surrounding air (storage) temperature | -40 ... 85 °C |
| Processing temperature | -25 ... +50 °C |

Standards and specifications

| | |
|--------------------------|--------------------------------------|
| Standards/specifications | EN 61010-2-201; EN 61810-1; EN 61373 |
|--------------------------|--------------------------------------|

Commercial data

| | |
|--------------------|---------------------------|
| Product Group | 6 (Interface Electronics) |
| Packaging type | BOX |
| Country of origin | DE |
| GTIN | 4055143568357 |
| Customs Tariff No. | 85364900990 |

Subject to changes. Please also observe the further product documentation!







WAGO Kontakttechnik GmbH & Co. KG
 Hansastr. 27
 32423 Minden
 Phone: +49571 887-0 | Fax: +49571 887-169
 Email: info.de@wago.com | Web: www.wago.com

Do you have any questions about our products?
 We are always happy to take your call at +49 (571) 887-44222.

Counterpart

Compatible products

Marking accessories

| | | |
|--|--|--|
|  | Item no.: 2009-110 Marking strips; on reel; not stretchable; plain; snap-on type; white | www.wago.com/2009-110 |
| | Item no.: 2009-115 WMB-Inline; for Smart Printer; 1500 pieces on roll; stretchable 5 - 5.2 mm; plain; snap-on type; white | www.wago.com/2009-115 |
| | Item no.: 2009-115/000-002 WMB-Inline; for Smart Printer; 1500 pieces on roll; stretchable 5 - 5.2 mm; plain; snap-on type; yellow | www.wago.com/2009-115/000-002 |
|  | Item no.: 2009-115/000-006 WMB-Inline; for Smart Printer; 1500 pieces on roll; stretchable 5 - 5.2 mm; plain; snap-on type; white | www.wago.com/2009-115/000-006 |
|  | Item no.: 2009-115/000-007 WMB-Inline; for Smart Printer; 1500 pieces on roll; stretchable 5 - 5.2 mm; plain; snap-on type; gray | www.wago.com/2009-115/000-007 |
|  | Item no.: 2009-115/000-012 WMB-Inline; for Smart Printer; 1500 pieces on roll; stretchable 5 - 5.2 mm; plain; snap-on type; white | www.wago.com/2009-115/000-012 |
| | Item no.: 2009-115/000-017 WMB-Inline; for Smart Printer; 1500 pieces on roll; stretchable 5 - 5.2 mm; plain; snap-on type; white | www.wago.com/2009-115/000-017 |
|  | Item no.: 2009-115/000-023 WMB-Inline; for Smart Printer; 1500 pieces on roll; stretchable 5 - 5.2 mm; plain; snap-on type; green | www.wago.com/2009-115/000-023 |
| | Item no.: 2009-115/000-024 WMB-Inline; for Smart Printer; 1500 pieces on roll; stretchable 5 - 5.2 mm; plain; snap-on type; white | www.wago.com/2009-115/000-024 |
|  | Item no.: 209-128 Adaptor; gray | www.wago.com/209-128 |
|  | Item no.: 209-183 Marker card; white | www.wago.com/209-183 |
| | Item no.: 210-110 Fiber-tip pen | www.wago.com/210-110 |

Subject to changes. Please also observe the further product documentation!

**Item no.: 249-105**

Group marker carrier; gray

www.wago.com/249-105**Item no.: 793-501**

WMB marking card; as card; not stretchable; plain; snap-on type; white

www.wago.com/793-501**Item no.: 793-501/000-002**

WMB marking card; as card; not stretchable; plain; snap-on type; yellow

www.wago.com/793-501/000-002**Item no.: 793-501/000-005**

WMB marking card; as card; not stretchable; plain; snap-on type; red

www.wago.com/793-501/000-005**Item no.: 793-501/000-006**

WMB marking card; as card; not stretchable; plain; snap-on type; blue

www.wago.com/793-501/000-006**Item no.: 793-501/000-007**

WMB marking card; as card; not stretchable; plain; snap-on type; gray

www.wago.com/793-501/000-007**Item no.: 793-501/000-012**

WMB marking card; as card; not stretchable; plain; snap-on type; orange

www.wago.com/793-501/000-012**Item no.: 793-501/000-017**

WMB marking card; as card; not stretchable; plain; snap-on type; light green

www.wago.com/793-501/000-017**Item no.: 793-501/000-023**

WMB marking card; as card; not stretchable; plain; snap-on type; green

www.wago.com/793-501/000-023**Item no.: 793-501/000-024**

WMB marking card; as card; not stretchable; plain; snap-on type; violet

www.wago.com/793-501/000-024**Item no.: 793-502**

WMB marking card; as card; MARKED; 1 ... 10 (10x); not stretchable; Horizontal marking; snap-on type; white

www.wago.com/793-502**Item no.: 793-502/000-002**

WMB marking card; as card; MARKED; 1 ... 10 (10x); not stretchable; Horizontal marking; snap-on type; yellow

www.wago.com/793-502/000-002**Item no.: 793-502/000-005**

WMB marking card; as card; MARKED; 1 ... 10 (10x); not stretchable; Horizontal marking; snap-on type; red

www.wago.com/793-502/000-005**Item no.: 793-502/000-006**

WMB marking card; as card; MARKED; 1 ... 10 (10x); not stretchable; Horizontal marking; snap-on type; blue

www.wago.com/793-502/000-006

Subject to changes. Please also observe the further product documentation!

WAGO Kontakttechnik GmbH & Co. KG

Hansastr. 27













32423 Minden

Phone: +49571 887-0 | Fax: +49571 887-169

Email: info.de@wago.com | Web: www.wago.com

Do you have any questions about our products?

We are always happy to take your call at +49 (571) 887-44222.

| | | |
|--|---|--|
|  | <p>Item no.: 793-502/000-007 WMB marking card; as card; MARKED; 1 ... 10 (10x); not stretchable; Horizontal marking; snap-on type; gray</p> | www.wago.com/793-502/000-007 |
|  | <p>Item no.: 793-502/000-012 WMB marking card; as card; MARKED; 1 ... 10 (10x); not stretchable; Horizontal marking; snap-on type; orange</p> | www.wago.com/793-502/000-012 |
|  | <p>Item no.: 793-502/000-017 WMB marking card; as card; MARKED; 1 ... 10 (10x); not stretchable; Horizontal marking; snap-on type; light green</p> | www.wago.com/793-502/000-017 |
|  | <p>Item no.: 793-502/000-023 WMB marking card; as card; MARKED; 1 ... 10 (10x); not stretchable; Horizontal marking; snap-on type; green</p> | www.wago.com/793-502/000-023 |
|  | <p>Item no.: 793-502/000-024 WMB marking card; as card; MARKED; 1 ... 10 (10x); not stretchable; Horizontal marking; snap-on type; violet</p> | www.wago.com/793-502/000-024 |
|  | <p>Item no.: 793-503 WMB marking card; as card; MARKED; 11 ... 20 (10x); not stretchable; Horizontal marking; snap-on type; white</p> | www.wago.com/793-503 |
|  | <p>Item no.: 793-503/000-002 WMB marking card; as card; MARKED; 11 ... 20 (10x); not stretchable; Horizontal marking; snap-on type; yellow</p> | www.wago.com/793-503/000-002 |
|  | <p>Item no.: 793-503/000-005 WMB marking card; as card; MARKED; 11 ... 20 (10x); not stretchable; Horizontal marking; snap-on type; red</p> | www.wago.com/793-503/000-005 |
|  | <p>Item no.: 793-503/000-006 WMB marking card; as card; MARKED; 11 ... 20 (10x); not stretchable; Horizontal marking; snap-on type; blue</p> | www.wago.com/793-503/000-006 |
|  | <p>Item no.: 793-503/000-007 WMB marking card; as card; MARKED; 11 ... 20 (10x); not stretchable; Horizontal marking; snap-on type; gray</p> | www.wago.com/793-503/000-007 |
|  | <p>Item no.: 793-503/000-012 WMB marking card; as card; MARKED; 11 ... 20 (10x); not stretchable; Horizontal marking; snap-on type; orange</p> | www.wago.com/793-503/000-012 |
|  | <p>Item no.: 793-503/000-017 WMB marking card; as card; MARKED; 11 ... 20 (10x); not stretchable; Horizontal marking; snap-on type; light green</p> | www.wago.com/793-503/000-017 |
|  | <p>Item no.: 793-503/000-023 WMB marking card; as card; MARKED; 11 ... 20 (10x); not stretchable; Horizontal marking; snap-on type; green</p> | www.wago.com/793-503/000-023 |
| | <p>Item no.: 793-503/000-024 WMB marking card; as card; MARKED; 11 ... 20 (10x); not stretchable; Horizontal marking; snap-on type;</p> | |

Subject to changes. Please also observe the further product documentation!



violet

www.wago.com/793-503/000-024



Item no.: 793-504

WMB marking card; as card; MARKED; 21 ... 30 (10x); not stretchable; Horizontal marking; snap-on type; www.wago.com/793-504
white



Item no.: 793-504/000-002

WMB marking card; as card; MARKED; 21 ... 30 (10x); not stretchable; Horizontal marking; snap-on type; www.wago.com/793-504/000-002
yellow



Item no.: 793-504/000-005

WMB marking card; as card; MARKED; 21 ... 30 (10x); not stretchable; Horizontal marking; snap-on type; www.wago.com/793-504/000-005
red



Item no.: 793-504/000-006

WMB marking card; as card; MARKED; 21 ... 30 (10x); not stretchable; Horizontal marking; snap-on type; www.wago.com/793-504/000-006
blue



Item no.: 793-504/000-012

WMB marking card; as card; MARKED; 21 ... 30 (10x); not stretchable; Horizontal marking; snap-on type; www.wago.com/793-504/000-012
orange



Item no.: 793-504/000-017

WMB marking card; as card; MARKED; 21 ... 30 (10x); not stretchable; Horizontal marking; snap-on type; www.wago.com/793-504/000-017
light green



Item no.: 793-504/000-023

WMB marking card; as card; MARKED; 21 ... 30 (10x); not stretchable; Horizontal marking; snap-on type; www.wago.com/793-504/000-023
green

Item no.: 793-505

WMB marking card; as card; MARKED; 31 ... 40 (10x); not stretchable; Horizontal marking; snap-on type; www.wago.com/793-505
white



Item no.: 793-505/000-005

WMB marking card; as card; MARKED; 31 ... 40 (10x); not stretchable; Horizontal marking; snap-on type; www.wago.com/793-505/000-005
red



Item no.: 793-505/000-006

WMB marking card; as card; MARKED; 31 ... 40 (10x); not stretchable; Horizontal marking; snap-on type; www.wago.com/793-505/000-006
blue



Item no.: 793-505/000-007

WMB marking card; as card; MARKED; 31 ... 40 (10x); not stretchable; Horizontal marking; snap-on type; www.wago.com/793-505/000-007
gray



Item no.: 793-505/000-012

WMB marking card; as card; MARKED; 31 ... 40 (10x); not stretchable; Horizontal marking; snap-on type; www.wago.com/793-505/000-012
orange

Item no.: 793-506

WMB marking card; as card; MARKED; 41 ... 50 (10x); not stretchable; Horizontal marking; snap-on type; www.wago.com/793-506

Subject to changes. Please also observe the further product documentation!



white

**Item no.: 793-506/000-005**

WMB marking card; as card; MARKED; 41 ... 50 (10x); not stretchable; Horizontal marking; snap-on type; red

www.wago.com/793-506/000-005**Item no.: 793-506/000-006**

WMB marking card; as card; MARKED; 41 ... 50 (10x); not stretchable; Horizontal marking; snap-on type; blue

www.wago.com/793-506/000-006**Item no.: 793-506/000-012**

WMB marking card; as card; MARKED; 41 ... 50 (10x); not stretchable; Horizontal marking; snap-on type; orange

www.wago.com/793-506/000-012**Item no.: 793-506/000-017**

WMB marking card; as card; MARKED; 41 ... 50 (10x); not stretchable; Horizontal marking; snap-on type; light green

www.wago.com/793-506/000-017**Item no.: 793-5501**

WMB marking card; as card; for terminal block width 5 - 17.5 mm; stretchable 5 - 5.2 mm; plain; snap-on type; white

www.wago.com/793-5501**Item no.: 793-5501/000-002**

WMB marking card; as card; for terminal block width 5 - 17.5 mm; stretchable 5 - 5.2 mm; plain; snap-on type; yellow

www.wago.com/793-5501/000-002**Item no.: 793-5501/000-005**

WMB marking card; as card; for terminal block width 5 - 17.5 mm; stretchable 5 - 5.2 mm; plain; snap-on type; red

www.wago.com/793-5501/000-005**Item no.: 793-5501/000-006**

WMB marking card; as card; for terminal block width 5 - 17.5 mm; stretchable 5 - 5.2 mm; plain; snap-on type; blue

www.wago.com/793-5501/000-006**Item no.: 793-5501/000-007**

WMB marking card; as card; for terminal block width 5 - 17.5 mm; stretchable 5 - 5.2 mm; plain; snap-on type; gray

www.wago.com/793-5501/000-007**Item no.: 793-5501/000-012**

WMB marking card; as card; for terminal block width 5 - 17.5 mm; stretchable 5 - 5.2 mm; plain; snap-on type; orange

www.wago.com/793-5501/000-012**Item no.: 793-5501/000-014**

WMB marking card; as card; for terminal block width 5 - 17.5 mm; stretchable 5 - 5.2 mm; plain; snap-on type; brown

www.wago.com/793-5501/000-014**Item no.: 793-5501/000-017**

WMB marking card; as card; for terminal block width 5 - 17.5 mm; stretchable 5 - 5.2 mm; plain; snap-on type; green

www.wago.com/793-5501/000-017**Item no.: 793-5501/000-023**

WMB marking card; as card; for terminal block width 5 - 17.5 mm; stretchable 5 - 5.2 mm; plain; snap-on type; light green

www.wago.com/793-5501/000-023

Subject to changes. Please also observe the further product documentation!

WAGO Kontakttechnik GmbH & Co. KG

Hansastr. 27











32423 Minden

Phone: +49571 887-0 | Fax: +49571 887-169

Email: info.de@wago.com | Web: www.wago.com

Do you have any questions about our products?

We are always happy to take your call at +49 (571) 887-44222.

| | | |
|--|---|--|
| | Item no.: 793-5501/000-024 WMB marking card; as card; for terminal block width 5 - 17.5 mm; stretchable 5 - 5.2 mm; plain; snap-on type; violet | www.wago.com/793-5501/000-024 |
|  | Item no.: 793-566 WMB marking card; as card; MARKED; 1 ... 50 (2x); not stretchable; Horizontal marking; snap-on type; white | www.wago.com/793-566 |
|  | Item no.: 793-566/000-002 WMB marking card; as card; MARKED; 1 ... 50 (2x); not stretchable; Horizontal marking; snap-on type; yellow | www.wago.com/793-566/000-002 |
|  | Item no.: 793-566/000-005 WMB marking card; as card; MARKED; 1 ... 50 (2x); not stretchable; Horizontal marking; snap-on type; red | www.wago.com/793-566/000-005 |
|  | Item no.: 793-566/000-006 WMB marking card; as card; MARKED; 1 ... 50 (2x); not stretchable; Horizontal marking; snap-on type; blue | www.wago.com/793-566/000-006 |
|  | Item no.: 793-566/000-007 WMB marking card; as card; MARKED; 1 ... 50 (2x); not stretchable; Horizontal marking; snap-on type; gray | www.wago.com/793-566/000-007 |
|  | Item no.: 793-566/000-012 WMB marking card; as card; MARKED; 1 ... 50 (2x); not stretchable; Horizontal marking; snap-on type; orange | www.wago.com/793-566/000-012 |
|  | Item no.: 793-566/000-017 WMB marking card; as card; MARKED; 1 ... 50 (2x); not stretchable; Horizontal marking; snap-on type; light green | www.wago.com/793-566/000-017 |
|  | Item no.: 793-566/000-023 WMB marking card; as card; MARKED; 1 ... 50 (2x); not stretchable; Horizontal marking; snap-on type; green | www.wago.com/793-566/000-023 |
|  | Item no.: 793-566/000-024 WMB marking card; as card; MARKED; 1 ... 50 (2x); not stretchable; Horizontal marking; snap-on type; violet | www.wago.com/793-566/000-024 |
| tools | | |
|  | Item no.: 210-719 Operating tool; Blade: 2.5 x 0.4 mm; with a partially insulated shaft | www.wago.com/210-719 |
| General accessories | | |
| | Item no.: 209-145 Group marker carrier; white | www.wago.com/209-145 |
| | Item no.: 209-184 Protection cover; transparent | www.wago.com/209-184 |
|  | Item no.: 788-122 Operation status indicator; 110 VDC | www.wago.com/788-122 |

Subject to changes. Please also observe the further product documentation!

Jumper



Item no.: 858-402

Push-in type jumper bar; for the coil side

www.wago.com/858-402

ferrule

Item no.: 216-241

Ferrule; Sleeve for 0.5 mm² / 20 AWG; insulated; electro-tin plated; electrolytic copper; gastight crimped; acc. to DIN 46228, Part 4/09.90; white

www.wago.com/216-241



Item no.: 216-242

Ferrule; Sleeve for 0.75 mm² / 18 AWG; insulated; electro-tin plated; electrolytic copper; gastight crimped; acc. to DIN 46228, Part 4/09.90; gray

www.wago.com/216-242

Item no.: 216-243

Ferrule; Sleeve for 1 mm² / AWG 18; insulated; electro-tin plated; electrolytic copper; gastight crimped; acc. to DIN 46228, Part 4/09.90; red

www.wago.com/216-243



Item no.: 216-244

Ferrule; Sleeve for 1.5 mm² / AWG 16; insulated; electro-tin plated; electrolytic copper; gastight crimped; acc. to DIN 46228, Part 4/09.90; black

www.wago.com/216-244

Downloads

Documentation

Instruction Leaflet

| | | | |
|---------------------------------|--|---------------|----------|
| Stecksocket für Elementarrelais | | pdf 2.6 MB | Download |
|---------------------------------|--|---------------|----------|

Additional Information

| | | | |
|--|---------|-----------------|----------|
| Disposal; Electrical and electronic equipment, Packaging | V 1.0.0 | pdf 265.8 kB | Download |
|--|---------|-----------------|----------|

CAD/CAE-Data

CAE data

| | | | |
|---------------------------|--|-----|----------|
| EPLAN Data Portal 858-392 | | URL | Download |
| WSCAD Universe 858-392 | | URL | Download |

Installation Notes

Subject to changes. Please also observe the further product documentation!

WAGO Kontakttechnik GmbH & Co. KG
 Hansastr. 27
 32423 Minden
 Phone: +49571 887-0 | Fax: +49571 887-169
 Email: info.de@wago.com | Web: www.wago.com

Do you have any questions about our products?
 We are always happy to take your call at +49 (571) 887-44222.

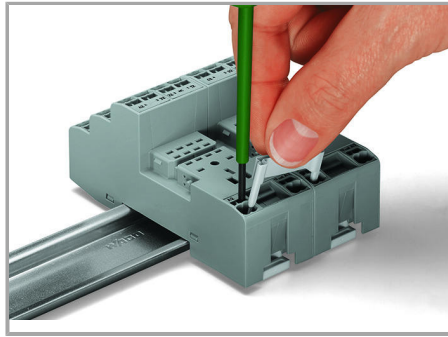
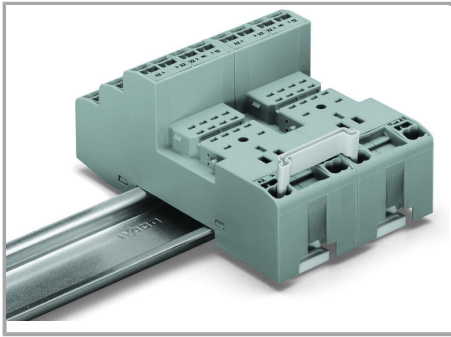

Remove jumper with screwdriver.

Marking

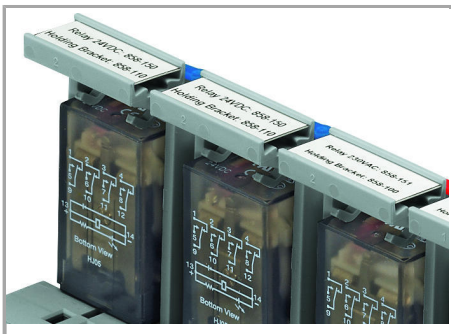

Marking using WMB Multi markers and group marker carriers

Subject to changes. Please also observe the further product documentation!