

**Data sheet | Item number: 857-801**

Temperature signal conditioner for RTD sensors; Current and voltage output signal; Configuration via software; Supply voltage: 24 VDC; 6 mm module width; light gray

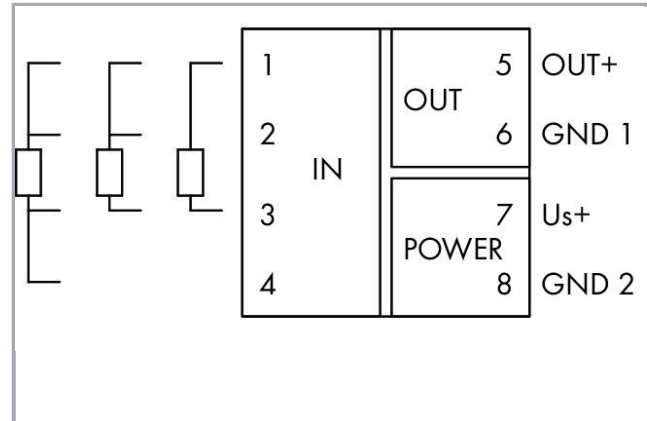

[www.wago.com/857-801](http://www.wago.com/857-801)

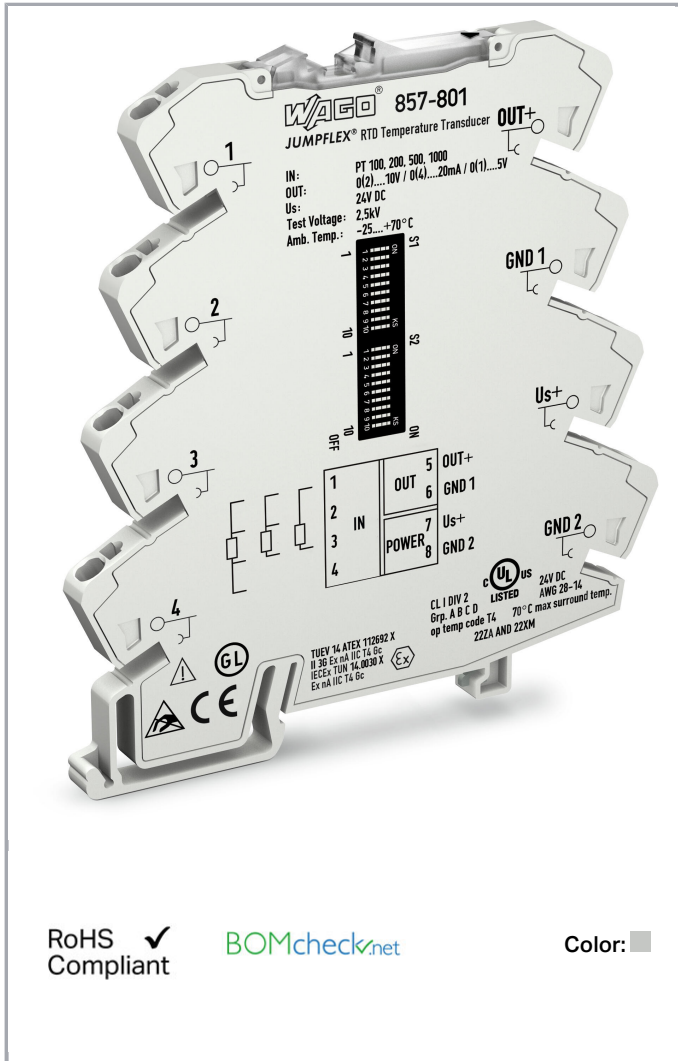

Subject to changes. Please also observe the further product documentation!

WAGO Kontakttechnik GmbH & Co. KG  
Hansastr. 27  
32423 Minden  
Phone: +49571 887-0 | Fax: +49571 887-169  
Email: [info.de@wago.com](mailto:info.de@wago.com) | Web: [www.wago.com](http://www.wago.com)

Do you have any questions about our products?  
We are always happy to take your call at +49 (571) 887-44222.

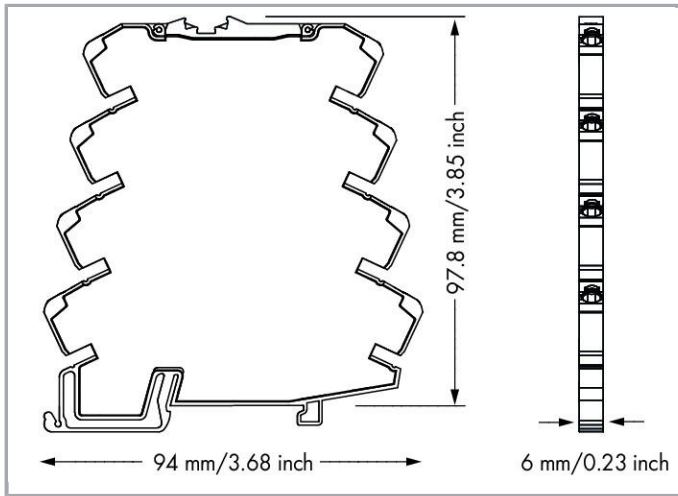

857-801  
DIP Switch Adjustability

• = ON    Default

DIP Switch S1

Wire Connection	Sensor Type	Output Signal	Measurement Range Underflow	Measurement Range Overflow	Wire Break	Short Circuit
2-wire	Pt100	0...20 mA	Lower limit of output range - 5 %*	Upper limit of output range + 2.5 %*	Upper limit of output range + 5 %*	Lower limit of output range - 2.5 %*
3-wire	Pt200	4...20 mA				
4-wire	Pt500	0...10 mA	Lower limit of output range	Upper limit of output range + 2.5 %	Upper limit of output range + 5 %	Lower limit of output range
	Pt1000	2...10 mA				
	1 kΩ	0...10 V	Lower limit of output range	Upper limit of output range	Upper limit of output range + 5 %	Upper limit of output range + 5 %
	4.5 kΩ	2...10 V				
		0...5 V	Lower limit of output range	Upper limit of output range	Lower limit of output range	Lower limit of output range
		1...5 V				

DIP Switch S2

Start Temperature										End Temperature													
1	2	3	4	°C	°F	5	6	7	8	9	10	°C	°F	5	6	7	8	9	10	°C	°F		
•	•	•	•	0	32	•	•	•	•	•	•	100	212	•	•	•	•	•	•	•	•	75	167
•	•	•	•	-200	-328	•	•	•	•	•	•	0	32	•	•	•	•	•	•	•	•	80	176
•	•	•	•	-175	-283	•	•	•	•	•	•	5	41	•	•	•	•	•	•	•	•	85	185
•	•	•	•	-150	-238	•	•	•	•	•	•	10	50	•	•	•	•	•	•	•	•	90	194
•	•	•	•	-125	-193	•	•	•	•	•	•	15	59	•	•	•	•	•	•	•	•	95	203
•	•	•	•	-100	-148	•	•	•	•	•	•	20	68	•	•	•	•	•	•	•	•	100	212
•	•	•	•	-90	-130	•	•	•	•	•	•	25	77	•	•	•	•	•	•	•	•	110	230
•	•	•	•	-80	-112	•	•	•	•	•	•	30	86	•	•	•	•	•	•	•	•	120	248
•	•	•	•	-70	-94	•	•	•	•	•	•	35	95	•	•	•	•	•	•	•	•	130	266
•	•	•	•	-60	-76	•	•	•	•	•	•	40	104	•	•	•	•	•	•	•	•	140	284
•	•	•	•	-50	-58	•	•	•	•	•	•	45	113	•	•	•	•	•	•	•	•	150	302
•	•	•	•	-40	-40	•	•	•	•	•	•	50	122	•	•	•	•	•	•	•	•	160	320
•	•	•	•	-30	-22	•	•	•	•	•	•	55	131	•	•	•	•	•	•	•	•	170	338
•	•	•	•	-20	-4	•	•	•	•	•	•	60	140	•	•	•	•	•	•	•	•	180	356
•	•	•	•	-10	14	•	•	•	•	•	•	65	149	•	•	•	•	•	•	•	•	190	374
•	•	•	•	0	32	•	•	•	•	•	•	70	158	•	•	•	•	•	•	•	•	200	392
•	•	•	•			•	•	•	•	•	•			•	•	•	•	•	•	•	•		

\* acc. to NAMUR NE 43

The minimum distance from the start temperature to the end temperature may not fall short of 50K degrees on the Celsius (C) scale or 122K degrees on the Fahrenheit (F) scale.

## Item description

### Short description:

This temperature signal conditioner records Pt100, Pt200, Pt500, and Pt1000 sensors, as well as resistors up to 4.5 kOhm, converting the temperature signal into a standard analog signal at the output.

### Features:

- PC configuration interface
- For Pt100, Pt200, Pt500 and Pt1000 sensors, as well as resistors up to 4.5 kOhm
- 2-, 3- and 4-wire connection technology
- Detects calibrated measurement range switching
- Detects a sensor wire break/short circuit
- Measurement range underflow/overflow
- Clipping capability for analog signal limitation to output end values
- Safe 3-way isolation with 2.5 kV test voltage per EN 61140

### Note:

Additional setting options as well as output signal inversion via interface configuration software or interface configuration app

## Data

### Technical Data

## Configuration

Configuration options

DIP switch

Subject to changes. Please also observe the further product documentation!

WAGO Kontakttechnik GmbH & Co. KG

Hansastr. 27

32423 Minden

Phone: +49571 887-0 | Fax: +49571 887-169

Email: info.de@wago.com | Web: www.wago.com

Do you have any questions about our products?

We are always happy to take your call at +49 (571) 887-44222.

## Input

Input signal type	Pt sensors Resistor
-------------------	------------------------

## Input – RTD sensors

Sensor types (RTD)	Pt100 Pt200 Pt500 Pt1000
Sensor connection	2-wire; 3-wire; 4-wire (switchable)
Max. sensor supply current (RTD)	≤ 0,5 mA
Measurement range temperature (RTD)	-200 ... 850°C
Min. measuring span (RTD)	50 K

## Input – Resistors

Input range resistance	0 ... 1 kΩ; 0 ... 4,5 kΩ
Min. measuring span	50 Ω

## Output – Analog

Output signal type	Current Voltage
Output signal voltage	0 ... 5 V; 1 ... 5 V; 0 ... 10 V; 2 ... 10 V
Output signal current	0 ... 10 mA; 2 ... 10 mA; 0 ... 20 mA; 4 ... 20 mA
Load impedance (output/voltage)	≥ 2 kΩ
Load impedance (output/current)	≤ 600 Ω

## Signal processing

Step response typ.	180 ms (2-wire); 360 ms (3-wire)
--------------------	----------------------------------

## Measurement error

Transmission error typ.	≤ 0.1 % at full measurement span
Transmission error of set measurement range	≤ ((10 K/set measurement range [K]) + 0.1) %
Temperature coefficient	≤ 0.02 %/K

Subject to changes. Please also observe the further product documentation!



## Power supply

Type of power supply	24 VDC
Nominal supply voltage $U_S$	DC 24 V
Supply voltage range	$\pm 30\%$
Current consumption at supply voltage	$\leq 40$ mA

## Safety and protection:

Test voltage (input/output/supply)	AC 2,5 kV; 50 Hz; 1 min
Protection class	IP20

## Connection data

Connection technology	Push-in CAGE CLAMP®
Solid conductor	0,08 ... 2,5 mm <sup>2</sup> / 28 ... 14 AWG
Fine-stranded conductor	0,34 ... 2,5 mm <sup>2</sup> / 22 ... 14 AWG
Strip length	9 ... 10 mm / 0.35 ... 0.39 inch

## Geometrical Data

Width	6 mm / 0.236 inch
Height from upper-edge of DIN-35 rail	97,8 mm / 3.85 inch
Depth	94 mm / 3.701 inch

## Mechanical data

Type of mounting	DIN-35 rail
------------------	-------------

## Material Data

Color	light gray
Weight	35.1 g

## Environmental Requirements

Surrounding air (operating) temperature	-25 ... 70 °C
Surrounding air (storage) temperature	-40 ... 85 °C

## Standards and specifications

Conformity marking	CE
--------------------	----

Subject to changes. Please also observe the further product documentation!



EMC immunity to interference	EN 61000-6-2
EMC emission of interference	EN 61000-6-4

### Commercial data

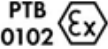

Product Group	6 (Interface Electronics)
Packaging type	bag
Country of origin	DE
GTIN	4045454502713
Customs Tariff No.	85437090300

### Approvals / Certificates

#### Ex-Approvals

Logo	Approval	Additional Approval Text	Certificate name
	IECEX TUEV Nord Cert GmbH	EN 60079-0	TÜV_14_ATEX_112692_X
	IECEX TUEV Nord Cert GmbH	IEC 60079-0	IECEX_TUN_14.0030_X
	UL UL International Germany GmbH (HAZARDOUS LOCATIONS)	ANSI/ISA 12.12.01	E198726 Sec.4

#### Ship Approvals

Logo	Approval	Additional Approval Text	Certificate name
	BV Bureau Veritas S.A.	-	40179_A0
	DNV GL Det Norske Veritas, Germanischer Lloyd	-	TAA00001D1
	NK Nippon Kaiji Kyokai	-	TA17255M

Subject to changes. Please also observe the further product documentation!

WAGO Kontakttechnik GmbH & Co. KG  
 Hansastr. 27  
 32423 Minden  
 Phone: +49571 887-0 | Fax: +49571 887-169  
 Email: [info.de@wago.com](mailto:info.de@wago.com) | Web: [www.wago.com](http://www.wago.com)

Do you have any questions about our products?  
 We are always happy to take your call at +49 (571) 887-44222.



PRS  
Polski Rejestr Statków

TE/2186  
/880590/18

### UL-Approvals

Logo	Approval	Additional Approval Text	Certificate name
	UL UL International Netherlands B.V. (ORDINARY LOCATIONS)	UL 508	E175199 Sec.4

### Counterpart

### Compatible products

#### transfer module



Item no.: 857-980  
Interface adapter; 16-pole; analog

[www.wago.com/857-980](http://www.wago.com/857-980)

#### General accessories

Item no.: 750-921  
Bluetooth® Adapter; light gray

[www.wago.com/750-921](http://www.wago.com/750-921)

Item no.: 750-923  
Configuration cable; USB connector; Length: 2.5 m; black

[www.wago.com/750-923](http://www.wago.com/750-923)

Item no.: 750-923/000-001  
Configuration cable; USB connector; Length: 5 m

[www.wago.com/750-923/000-001](http://www.wago.com/750-923/000-001)

Item no.: 857-979  
Supply and through module; 2,50 mm<sup>2</sup>

[www.wago.com/857-979](http://www.wago.com/857-979)

#### Marking accessories

Item no.: 2009-110  
Marking strips; on reel; not stretchable; plain; snap-on type; white

[www.wago.com/2009-110](http://www.wago.com/2009-110)

Subject to changes. Please also observe the further product documentation!

WAGO Kontakttechnik GmbH & Co. KG  
Hansastr. 27  
32423 Minden  
Phone: +49571 887-0 | Fax: +49571 887-169  
Email: [info.de@wago.com](mailto:info.de@wago.com) | Web: [www.wago.com](http://www.wago.com)

Do you have any questions about our products?  
We are always happy to take your call at +49 (571) 887-44222.

Item no.: 2009-115

WMB-Inline; for Smart Printer; 1500 pieces on roll; stretchable 5 - 5.2 mm; plain; snap-on type; white

[www.wago.com/2009-115](http://www.wago.com/2009-115)

Item no.: 2009-115/000-002

WMB-Inline; for Smart Printer; 1500 pieces on roll; stretchable 5 - 5.2 mm; plain; snap-on type; yellow

[www.wago.com/2009-115/000-002](http://www.wago.com/2009-115/000-002)



Item no.: 2009-115/000-006

WMB-Inline; for Smart Printer; 1500 pieces on roll; stretchable 5 - 5.2 mm; plain; snap-on type; white

[www.wago.com/2009-115/000-006](http://www.wago.com/2009-115/000-006)



Item no.: 2009-115/000-007

WMB-Inline; for Smart Printer; 1500 pieces on roll; stretchable 5 - 5.2 mm; plain; snap-on type; gray

[www.wago.com/2009-115/000-007](http://www.wago.com/2009-115/000-007)



Item no.: 2009-115/000-012

WMB-Inline; for Smart Printer; 1500 pieces on roll; stretchable 5 - 5.2 mm; plain; snap-on type; white

[www.wago.com/2009-115/000-012](http://www.wago.com/2009-115/000-012)

Item no.: 2009-115/000-017

WMB-Inline; for Smart Printer; 1500 pieces on roll; stretchable 5 - 5.2 mm; plain; snap-on type; white

[www.wago.com/2009-115/000-017](http://www.wago.com/2009-115/000-017)



Item no.: 2009-115/000-023

WMB-Inline; for Smart Printer; 1500 pieces on roll; stretchable 5 - 5.2 mm; plain; snap-on type; green

[www.wago.com/2009-115/000-023](http://www.wago.com/2009-115/000-023)

Item no.: 2009-115/000-024

WMB-Inline; for Smart Printer; 1500 pieces on roll; stretchable 5 - 5.2 mm; plain; snap-on type; white

[www.wago.com/2009-115/000-024](http://www.wago.com/2009-115/000-024)

Item no.: 793-501

WMB marking card; as card; not stretchable; plain; snap-on type; white

[www.wago.com/793-501](http://www.wago.com/793-501)



Item no.: 793-501/000-002

WMB marking card; as card; not stretchable; plain; snap-on type; yellow

[www.wago.com/793-501/000-002](http://www.wago.com/793-501/000-002)

Item no.: 793-501/000-005

WMB marking card; as card; not stretchable; plain; snap-on type; red

[www.wago.com/793-501/000-005](http://www.wago.com/793-501/000-005)

Item no.: 793-501/000-006

WMB marking card; as card; not stretchable; plain; snap-on type; blue

[www.wago.com/793-501/000-006](http://www.wago.com/793-501/000-006)

Item no.: 793-501/000-007

WMB marking card; as card; not stretchable; plain; snap-on type; gray

[www.wago.com/793-501/000-007](http://www.wago.com/793-501/000-007)

Item no.: 793-501/000-012

WMB marking card; as card; not stretchable; plain; snap-on type; orange

[www.wago.com/793-501/000-012](http://www.wago.com/793-501/000-012)

Subject to changes. Please also observe the further product documentation!

WAGO Kontakttechnik GmbH & Co. KG

Hansastr. 27











32423 Minden

Phone: +49571 887-0 | Fax: +49571 887-169

Email: [info.de@wago.com](mailto:info.de@wago.com) | Web: [www.wago.com](http://www.wago.com)

Do you have any questions about our products?

We are always happy to take your call at +49 (571) 887-44222.

	<p><b>Item no.: 793-501/000-017</b> WMB marking card; as card; not stretchable; plain; snap-on type; light green</p>	<p><a href="http://www.wago.com/793-501/000-017">www.wago.com/793-501/000-017</a></p>
	<p><b>Item no.: 793-501/000-023</b> WMB marking card; as card; not stretchable; plain; snap-on type; green</p>	<p><a href="http://www.wago.com/793-501/000-023">www.wago.com/793-501/000-023</a></p>
	<p><b>Item no.: 793-501/000-024</b> WMB marking card; as card; not stretchable; plain; snap-on type; violet</p>	<p><a href="http://www.wago.com/793-501/000-024">www.wago.com/793-501/000-024</a></p>
	<p><b>Item no.: 793-502</b> WMB marking card; as card; MARKED; 1 ... 10 (10x); not stretchable; Horizontal marking; snap-on type; white</p>	<p><a href="http://www.wago.com/793-502">www.wago.com/793-502</a></p>
	<p><b>Item no.: 793-502/000-002</b> WMB marking card; as card; MARKED; 1 ... 10 (10x); not stretchable; Horizontal marking; snap-on type; yellow</p>	<p><a href="http://www.wago.com/793-502/000-002">www.wago.com/793-502/000-002</a></p>
	<p><b>Item no.: 793-502/000-005</b> WMB marking card; as card; MARKED; 1 ... 10 (10x); not stretchable; Horizontal marking; snap-on type; red</p>	<p><a href="http://www.wago.com/793-502/000-005">www.wago.com/793-502/000-005</a></p>
	<p><b>Item no.: 793-502/000-006</b> WMB marking card; as card; MARKED; 1 ... 10 (10x); not stretchable; Horizontal marking; snap-on type; blue</p>	<p><a href="http://www.wago.com/793-502/000-006">www.wago.com/793-502/000-006</a></p>
	<p><b>Item no.: 793-502/000-007</b> WMB marking card; as card; MARKED; 1 ... 10 (10x); not stretchable; Horizontal marking; snap-on type; gray</p>	<p><a href="http://www.wago.com/793-502/000-007">www.wago.com/793-502/000-007</a></p>
	<p><b>Item no.: 793-502/000-012</b> WMB marking card; as card; MARKED; 1 ... 10 (10x); not stretchable; Horizontal marking; snap-on type; orange</p>	<p><a href="http://www.wago.com/793-502/000-012">www.wago.com/793-502/000-012</a></p>
	<p><b>Item no.: 793-502/000-017</b> WMB marking card; as card; MARKED; 1 ... 10 (10x); not stretchable; Horizontal marking; snap-on type; light green</p>	<p><a href="http://www.wago.com/793-502/000-017">www.wago.com/793-502/000-017</a></p>
	<p><b>Item no.: 793-502/000-023</b> WMB marking card; as card; MARKED; 1 ... 10 (10x); not stretchable; Horizontal marking; snap-on type; green</p>	<p><a href="http://www.wago.com/793-502/000-023">www.wago.com/793-502/000-023</a></p>
	<p><b>Item no.: 793-502/000-024</b> WMB marking card; as card; MARKED; 1 ... 10 (10x); not stretchable; Horizontal marking; snap-on type; violet</p>	<p><a href="http://www.wago.com/793-502/000-024">www.wago.com/793-502/000-024</a></p>
	<p><b>Item no.: 793-503</b> WMB marking card; as card; MARKED; 11 ... 20 (10x); not stretchable; Horizontal marking; snap-on type; white</p>	<p><a href="http://www.wago.com/793-503">www.wago.com/793-503</a></p>
	<p><b>Item no.: 793-503/000-002</b> WMB marking card; as card; MARKED; 11 ... 20 (10x); not stretchable; Horizontal marking; snap-on type;</p>	<p><a href="http://www.wago.com/793-503/000-002">www.wago.com/793-503/000-002</a></p>

Subject to changes. Please also observe the further product documentation!



yellow

**Item no.: 793-503/000-005**WMB marking card; as card; MARKED; 11 ... 20 (10x); not stretchable; Horizontal marking; snap-on type; red [www.wago.com/793-503/000-005](http://www.wago.com/793-503/000-005)**Item no.: 793-503/000-006**WMB marking card; as card; MARKED; 11 ... 20 (10x); not stretchable; Horizontal marking; snap-on type; blue [www.wago.com/793-503/000-006](http://www.wago.com/793-503/000-006)**Item no.: 793-503/000-007**WMB marking card; as card; MARKED; 11 ... 20 (10x); not stretchable; Horizontal marking; snap-on type; gray [www.wago.com/793-503/000-007](http://www.wago.com/793-503/000-007)**Item no.: 793-503/000-012**WMB marking card; as card; MARKED; 11 ... 20 (10x); not stretchable; Horizontal marking; snap-on type; orange [www.wago.com/793-503/000-012](http://www.wago.com/793-503/000-012)**Item no.: 793-503/000-017**WMB marking card; as card; MARKED; 11 ... 20 (10x); not stretchable; Horizontal marking; snap-on type; light green [www.wago.com/793-503/000-017](http://www.wago.com/793-503/000-017)**Item no.: 793-503/000-023**WMB marking card; as card; MARKED; 11 ... 20 (10x); not stretchable; Horizontal marking; snap-on type; green [www.wago.com/793-503/000-023](http://www.wago.com/793-503/000-023)**Item no.: 793-503/000-024**WMB marking card; as card; MARKED; 11 ... 20 (10x); not stretchable; Horizontal marking; snap-on type; violet [www.wago.com/793-503/000-024](http://www.wago.com/793-503/000-024)**Item no.: 793-504**WMB marking card; as card; MARKED; 21 ... 30 (10x); not stretchable; Horizontal marking; snap-on type; white [www.wago.com/793-504](http://www.wago.com/793-504)**Item no.: 793-504/000-002**WMB marking card; as card; MARKED; 21 ... 30 (10x); not stretchable; Horizontal marking; snap-on type; yellow [www.wago.com/793-504/000-002](http://www.wago.com/793-504/000-002)**Item no.: 793-504/000-005**WMB marking card; as card; MARKED; 21 ... 30 (10x); not stretchable; Horizontal marking; snap-on type; red [www.wago.com/793-504/000-005](http://www.wago.com/793-504/000-005)**Item no.: 793-504/000-006**WMB marking card; as card; MARKED; 21 ... 30 (10x); not stretchable; Horizontal marking; snap-on type; blue [www.wago.com/793-504/000-006](http://www.wago.com/793-504/000-006)**Item no.: 793-504/000-012**WMB marking card; as card; MARKED; 21 ... 30 (10x); not stretchable; Horizontal marking; snap-on type; orange [www.wago.com/793-504/000-012](http://www.wago.com/793-504/000-012)**Item no.: 793-504/000-017**WMB marking card; as card; MARKED; 21 ... 30 (10x); not stretchable; Horizontal marking; snap-on type; light green [www.wago.com/793-504/000-017](http://www.wago.com/793-504/000-017)

Subject to changes. Please also observe the further product documentation!



**Item no.: 793-504/000-023**

WMB marking card; as card; MARKED; 21 ... 30 (10x); not stretchable; Horizontal marking; snap-on type; green

[www.wago.com/793-504/000-023](http://www.wago.com/793-504/000-023)

**Item no.: 793-505**

WMB marking card; as card; MARKED; 31 ... 40 (10x); not stretchable; Horizontal marking; snap-on type; white

[www.wago.com/793-505](http://www.wago.com/793-505)



**Item no.: 793-505/000-005**

WMB marking card; as card; MARKED; 31 ... 40 (10x); not stretchable; Horizontal marking; snap-on type; red

[www.wago.com/793-505/000-005](http://www.wago.com/793-505/000-005)



**Item no.: 793-505/000-006**

WMB marking card; as card; MARKED; 31 ... 40 (10x); not stretchable; Horizontal marking; snap-on type; blue

[www.wago.com/793-505/000-006](http://www.wago.com/793-505/000-006)



**Item no.: 793-505/000-007**

WMB marking card; as card; MARKED; 31 ... 40 (10x); not stretchable; Horizontal marking; snap-on type; gray

[www.wago.com/793-505/000-007](http://www.wago.com/793-505/000-007)



**Item no.: 793-505/000-012**

WMB marking card; as card; MARKED; 31 ... 40 (10x); not stretchable; Horizontal marking; snap-on type; orange

[www.wago.com/793-505/000-012](http://www.wago.com/793-505/000-012)



**Item no.: 793-506**

WMB marking card; as card; MARKED; 41 ... 50 (10x); not stretchable; Horizontal marking; snap-on type; white

[www.wago.com/793-506](http://www.wago.com/793-506)



**Item no.: 793-506/000-005**

WMB marking card; as card; MARKED; 41 ... 50 (10x); not stretchable; Horizontal marking; snap-on type; red

[www.wago.com/793-506/000-005](http://www.wago.com/793-506/000-005)



**Item no.: 793-506/000-006**

WMB marking card; as card; MARKED; 41 ... 50 (10x); not stretchable; Horizontal marking; snap-on type; blue

[www.wago.com/793-506/000-006](http://www.wago.com/793-506/000-006)



**Item no.: 793-506/000-012**

WMB marking card; as card; MARKED; 41 ... 50 (10x); not stretchable; Horizontal marking; snap-on type; orange

[www.wago.com/793-506/000-012](http://www.wago.com/793-506/000-012)



**Item no.: 793-506/000-017**

WMB marking card; as card; MARKED; 41 ... 50 (10x); not stretchable; Horizontal marking; snap-on type; light green

[www.wago.com/793-506/000-017](http://www.wago.com/793-506/000-017)



**Item no.: 793-5501**

WMB marking card; as card; for terminal block width 5 - 17.5 mm; stretchable 5 - 5.2 mm; plain; snap-on type; white

[www.wago.com/793-5501](http://www.wago.com/793-5501)



**Item no.: 793-5501/000-002**

WMB marking card; as card; for terminal block width 5 - 17.5 mm; stretchable 5 - 5.2 mm; plain; snap-on type; yellow

[www.wago.com/793-5501/000-002](http://www.wago.com/793-5501/000-002)















**Item no.: 793-5501/000-005**

WMB marking card; as card; for terminal block width 5 - 17.5 mm; stretchable 5 - 5.2 mm; plain; snap-on type; red

[www.wago.com/793-5501/000-005](http://www.wago.com/793-5501/000-005)

Subject to changes. Please also observe the further product documentation!

	<b>Item no.: 793-5501/000-006</b> WMB marking card; as card; for terminal block width 5 - 17.5 mm; stretchable 5 - 5.2 mm; plain; snap-on type; blue	<a href="http://www.wago.com/793-5501/000-006">www.wago.com/793-5501/000-006</a>
	<b>Item no.: 793-5501/000-007</b> WMB marking card; as card; for terminal block width 5 - 17.5 mm; stretchable 5 - 5.2 mm; plain; snap-on type; gray	<a href="http://www.wago.com/793-5501/000-007">www.wago.com/793-5501/000-007</a>
	<b>Item no.: 793-5501/000-012</b> WMB marking card; as card; for terminal block width 5 - 17.5 mm; stretchable 5 - 5.2 mm; plain; snap-on type; orange	<a href="http://www.wago.com/793-5501/000-012">www.wago.com/793-5501/000-012</a>
	<b>Item no.: 793-5501/000-014</b> WMB marking card; as card; for terminal block width 5 - 17.5 mm; stretchable 5 - 5.2 mm; plain; snap-on type; brown	<a href="http://www.wago.com/793-5501/000-014">www.wago.com/793-5501/000-014</a>
	<b>Item no.: 793-5501/000-017</b> WMB marking card; as card; for terminal block width 5 - 17.5 mm; stretchable 5 - 5.2 mm; plain; snap-on type; green	<a href="http://www.wago.com/793-5501/000-017">www.wago.com/793-5501/000-017</a>
	<b>Item no.: 793-5501/000-023</b> WMB marking card; as card; for terminal block width 5 - 17.5 mm; stretchable 5 - 5.2 mm; plain; snap-on type; light green	<a href="http://www.wago.com/793-5501/000-023">www.wago.com/793-5501/000-023</a>
	<b>Item no.: 793-5501/000-024</b> WMB marking card; as card; for terminal block width 5 - 17.5 mm; stretchable 5 - 5.2 mm; plain; snap-on type; violet	<a href="http://www.wago.com/793-5501/000-024">www.wago.com/793-5501/000-024</a>
	<b>Item no.: 793-566</b> WMB marking card; as card; MARKED; 1 ... 50 (2x); not stretchable; Horizontal marking; snap-on type; white	<a href="http://www.wago.com/793-566">www.wago.com/793-566</a>
	<b>Item no.: 793-566/000-002</b> WMB marking card; as card; MARKED; 1 ... 50 (2x); not stretchable; Horizontal marking; snap-on type; yellow	<a href="http://www.wago.com/793-566/000-002">www.wago.com/793-566/000-002</a>
	<b>Item no.: 793-566/000-005</b> WMB marking card; as card; MARKED; 1 ... 50 (2x); not stretchable; Horizontal marking; snap-on type; red	<a href="http://www.wago.com/793-566/000-005">www.wago.com/793-566/000-005</a>
	<b>Item no.: 793-566/000-006</b> WMB marking card; as card; MARKED; 1 ... 50 (2x); not stretchable; Horizontal marking; snap-on type; blue	<a href="http://www.wago.com/793-566/000-006">www.wago.com/793-566/000-006</a>
	<b>Item no.: 793-566/000-007</b> WMB marking card; as card; MARKED; 1 ... 50 (2x); not stretchable; Horizontal marking; snap-on type; gray	<a href="http://www.wago.com/793-566/000-007">www.wago.com/793-566/000-007</a>
	<b>Item no.: 793-566/000-012</b> WMB marking card; as card; MARKED; 1 ... 50 (2x); not stretchable; Horizontal marking; snap-on type; orange	<a href="http://www.wago.com/793-566/000-012">www.wago.com/793-566/000-012</a>
	<b>Item no.: 793-566/000-017</b>	

Subject to changes. Please also observe the further product documentation!



WMB marking card; as card; MARKED; 1 ... 50 (2x); not stretchable; Horizontal marking; snap-on type; light green

[www.wago.com/793-566/000-017](http://www.wago.com/793-566/000-017)



**Item no.: 793-566/000-023**

WMB marking card; as card; MARKED; 1 ... 50 (2x); not stretchable; Horizontal marking; snap-on type; green

[www.wago.com/793-566/000-023](http://www.wago.com/793-566/000-023)



**Item no.: 793-566/000-024**

WMB marking card; as card; MARKED; 1 ... 50 (2x); not stretchable; Horizontal marking; snap-on type; violet

[www.wago.com/793-566/000-024](http://www.wago.com/793-566/000-024)

### assembling

**Item no.: 249-116**

Screwless end stop; 6 mm wide; for DIN-rail 35 x 15 and 35 x 7.5; gray

[www.wago.com/249-116](http://www.wago.com/249-116)

**Item no.: 249-117**

Screwless end stop; 10 mm wide; for DIN-rail 35 x 15 and 35 x 7.5; gray

[www.wago.com/249-117](http://www.wago.com/249-117)

**Item no.: 249-197**

Screwless end stop; 14 mm wide; for DIN-rail 35 x 15 and 35 x 7.5; gray

[www.wago.com/249-197](http://www.wago.com/249-197)

### power supply



**Item no.: 787-2852**

Switched-mode power supply; for JUMPFLEX® Signal Conditioners; 1-phase; 24 VDC output voltage; 1 A output current; -

[www.wago.com/787-2852](http://www.wago.com/787-2852)

### tools

**Item no.: 210-720**

Operating tool; Blade: 3.5 x 0.5 mm; with a partially insulated shaft

[www.wago.com/210-720](http://www.wago.com/210-720)

### Jumper



**Item no.: 281-482**

Comb-style jumper bar; insulated; 2-way; IN = IN terminal block; gray

[www.wago.com/281-482](http://www.wago.com/281-482)



**Item no.: 859-402**

Push-in type jumper bar; 2-way; Nominal current 18 A; insulated; light gray

[www.wago.com/859-402](http://www.wago.com/859-402)



**Item no.: 859-402/000-005**

Push-in type jumper bar; 2-way; Nominal current 18 A; insulated; red

[www.wago.com/859-402/000-005](http://www.wago.com/859-402/000-005)



**Item no.: 859-402/000-006**

Push-in type jumper bar; 2-way; Nominal current 18 A; insulated; blue

[www.wago.com/859-402/000-006](http://www.wago.com/859-402/000-006)



**Item no.: 859-402/000-029**

Push-in type jumper bar; 2-way; Nominal current 18 A; insulated; yellow

[www.wago.com/859-402/000-029](http://www.wago.com/859-402/000-029)













**Item no.: 859-403**

Push-in type jumper bar; 3-way; Nominal current 18 A; insulated; light gray

[www.wago.com/859-403](http://www.wago.com/859-403)

Subject to changes. Please also observe the further product documentation!

	<b>Item no.: 859-403/000-005</b> Push-in type jumper bar; 3-way; Nominal current 18 A; insulated; red	<a href="http://www.wago.com/859-403/000-005">www.wago.com/859-403/000-005</a>
	<b>Item no.: 859-403/000-006</b> Push-in type jumper bar; 3-way; Nominal current 18 A; insulated; blue	<a href="http://www.wago.com/859-403/000-006">www.wago.com/859-403/000-006</a>
	<b>Item no.: 859-403/000-029</b> Push-in type jumper bar; 3-way; Nominal current 18 A; insulated; yellow	<a href="http://www.wago.com/859-403/000-029">www.wago.com/859-403/000-029</a>
	<b>Item no.: 859-404</b> Push-in type jumper bar; 4-way; Nominal current 18 A; insulated; light gray	<a href="http://www.wago.com/859-404">www.wago.com/859-404</a>
	<b>Item no.: 859-404/000-005</b> Push-in type jumper bar; 4-way; Nominal current 18 A; insulated; red	<a href="http://www.wago.com/859-404/000-005">www.wago.com/859-404/000-005</a>
	<b>Item no.: 859-404/000-006</b> Push-in type jumper bar; 4-way; Nominal current 18 A; insulated; blue	<a href="http://www.wago.com/859-404/000-006">www.wago.com/859-404/000-006</a>
	<b>Item no.: 859-404/000-029</b> Push-in type jumper bar; 4-way; Nominal current 18 A; insulated; yellow	<a href="http://www.wago.com/859-404/000-029">www.wago.com/859-404/000-029</a>
	<b>Item no.: 859-405</b> Push-in type jumper bar; 5-way; Nominal current 18 A; insulated; light gray	<a href="http://www.wago.com/859-405">www.wago.com/859-405</a>
	<b>Item no.: 859-405/000-005</b> Push-in type jumper bar; 5-way; Nominal current 18 A; insulated; red	<a href="http://www.wago.com/859-405/000-005">www.wago.com/859-405/000-005</a>
	<b>Item no.: 859-405/000-006</b> Push-in type jumper bar; 5-way; Nominal current 18 A; insulated; blue	<a href="http://www.wago.com/859-405/000-006">www.wago.com/859-405/000-006</a>
	<b>Item no.: 859-405/000-029</b> Push-in type jumper bar; 5-way; Nominal current 18 A; insulated; yellow	<a href="http://www.wago.com/859-405/000-029">www.wago.com/859-405/000-029</a>
	<b>Item no.: 859-406</b> Push-in type jumper bar; 6-way; Nominal current 18 A; insulated; light gray	<a href="http://www.wago.com/859-406">www.wago.com/859-406</a>
	<b>Item no.: 859-406/000-005</b> Push-in type jumper bar; 6-way; Nominal current 18 A; insulated; red	<a href="http://www.wago.com/859-406/000-005">www.wago.com/859-406/000-005</a>
	<b>Item no.: 859-406/000-006</b> Push-in type jumper bar; 6-way; Nominal current 18 A; insulated; blue	<a href="http://www.wago.com/859-406/000-006">www.wago.com/859-406/000-006</a>

Subject to changes. Please also observe the further product documentation!



**Item no.: 859-406/000-029**

Push-in type jumper bar; 6-way; Nominal current 18 A; insulated; yellow

[www.wago.com/859-406/000-029](http://www.wago.com/859-406/000-029)



**Item no.: 859-407**

Push-in type jumper bar; 7-way; Nominal current 18 A; insulated; light gray

[www.wago.com/859-407](http://www.wago.com/859-407)



**Item no.: 859-407/000-005**

Push-in type jumper bar; 7-way; Nominal current 18 A; insulated; red

[www.wago.com/859-407/000-005](http://www.wago.com/859-407/000-005)

**Item no.: 859-407/000-006**

Push-in type jumper bar; 7-way; Nominal current 18 A; insulated; blue

[www.wago.com/859-407/000-006](http://www.wago.com/859-407/000-006)



**Item no.: 859-407/000-029**

Push-in type jumper bar; 7-way; Nominal current 18 A; insulated; yellow

[www.wago.com/859-407/000-029](http://www.wago.com/859-407/000-029)



**Item no.: 859-408**

Push-in type jumper bar; 8-way; Nominal current 18 A; insulated; light gray

[www.wago.com/859-408](http://www.wago.com/859-408)



**Item no.: 859-408/000-005**

Push-in type jumper bar; 8-way; Nominal current 18 A; insulated; red

[www.wago.com/859-408/000-005](http://www.wago.com/859-408/000-005)

**Item no.: 859-408/000-006**

Push-in type jumper bar; 8-way; Nominal current 18 A; insulated; blue

[www.wago.com/859-408/000-006](http://www.wago.com/859-408/000-006)



**Item no.: 859-408/000-029**

Push-in type jumper bar; 8-way; Nominal current 18 A; insulated; yellow

[www.wago.com/859-408/000-029](http://www.wago.com/859-408/000-029)

**Item no.: 859-409**

Push-in type jumper bar; 9-way; Nominal current 18 A; insulated; light gray

[www.wago.com/859-409](http://www.wago.com/859-409)

**Item no.: 859-409/000-005**

Push-in type jumper bar; 9-way; Nominal current 18 A; insulated; red

[www.wago.com/859-409/000-005](http://www.wago.com/859-409/000-005)



**Item no.: 859-409/000-006**

Push-in type jumper bar; 9-way; Nominal current 18 A; insulated; blue

[www.wago.com/859-409/000-006](http://www.wago.com/859-409/000-006)



**Item no.: 859-409/000-029**

Push-in type jumper bar; 9-way; Nominal current 18 A; insulated; yellow

[www.wago.com/859-409/000-029](http://www.wago.com/859-409/000-029)



**Item no.: 859-410**

Push-in type jumper bar; 10-way; Nominal current 18 A; insulated; light gray

[www.wago.com/859-410](http://www.wago.com/859-410)

Subject to changes. Please also observe the further product documentation!

WAGO Kontakttechnik GmbH & Co. KG

Hansastr. 27

32423 Minden

Phone: +49571 887-0 | Fax: +49571 887-169

Email: [info.de@wago.com](mailto:info.de@wago.com) | Web: [www.wago.com](http://www.wago.com)

Do you have any questions about our products?

We are always happy to take your call at +49 (571) 887-44222.



Item no.: 859-410/000-005

Push-in type jumper bar; 10-way; Nominal current 18 A; insulated; red

[www.wago.com/859-410/000-005](http://www.wago.com/859-410/000-005)

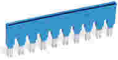

Item no.: 859-410/000-006

Push-in type jumper bar; 10-way; Nominal current 18 A; insulated; blue

[www.wago.com/859-410/000-006](http://www.wago.com/859-410/000-006)



Item no.: 859-410/000-029

Push-in type jumper bar; 10-way; Nominal current 18 A; insulated; yellow

[www.wago.com/859-410/000-029](http://www.wago.com/859-410/000-029)

## Downloads

### Documentation

#### Instruction Leaflet

Messumformer und Trennverstärker

Temperaturmessumformer Pt100, Pt200, Pt500, Pt1000, Widerstände 0 ... 1 kOhm, 0 ... 4,5 kOhm DIP-Schalter / FDT/DTM Software

pdf  
2.2 MB

Download

#### Additional Information

Disposal; Electrical and electronic equipment, Packaging

V 1.0.0

pdf  
265.8 kB

Download

## Engineering-Software

### Software for Interface-Products

WAGO Interface Configuration Software FULL

The full setup, in addition to the WAGO Interface Configuration Software, includes the installation for the Microsoft .NET Framework.

1.6.3.7  
Sep 17, 2019

exe  
98.5 MB

Download

WAGO Interface Configuration Software SMALL

The full setup only includes the WAGO Interface Configuration Software.

1.6.3.7  
Sep 17, 2019

exe  
48.0 MB

Download

## CAD/CAE-Data

### CAD data

2D/3D Models 857-801

URL

Download

### CAE data

Subject to changes. Please also observe the further product documentation!

WAGO Kontakttechnik GmbH & Co. KG

Hansastr. 27

32423 Minden

Phone: +49571 887-0 | Fax: +49571 887-169

Email: [info.de@wago.com](mailto:info.de@wago.com) | Web: [www.wago.com](http://www.wago.com)

Do you have any questions about our products?

We are always happy to take your call at +49 (571) 887-44222.

## Installation Notes

### Configuring

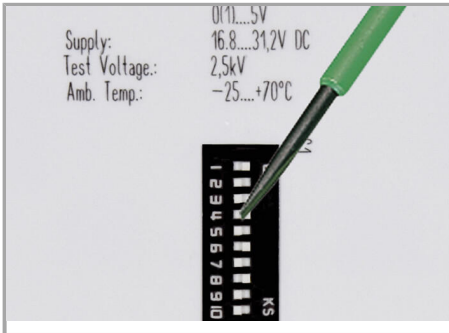

Configuration via DIP switches

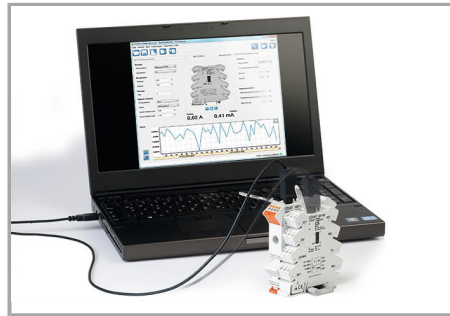

Configuration via WAGO interface configuration software

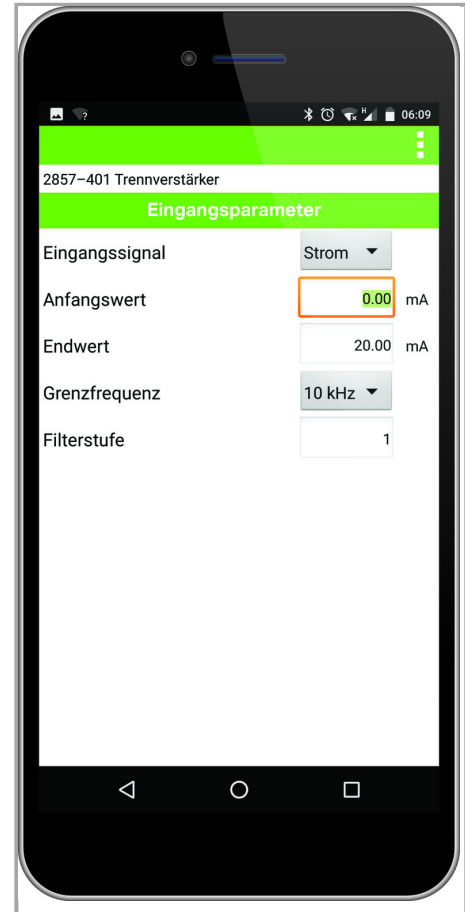

Configuration via WAGO interface configuration app

### Commoning

Subject to changes. Please also observe the further product documentation!



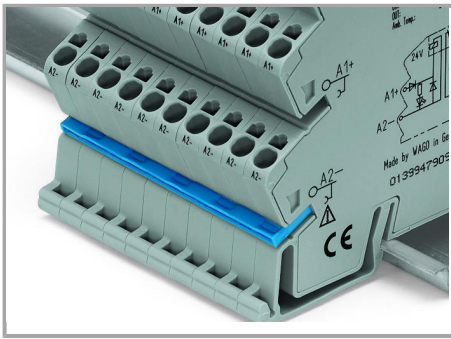

Commoning, not discrete wiring – same outline allows the use of a single in-line, push-in jumper

Subject to changes. Please also observe the further product documentation!

WAGO Kontakttechnik GmbH & Co. KG  
Hansastr. 27  
32423 Minden  
Phone: +49571 887-0 | Fax: +49571 887-169  
Email: [info.de@wago.com](mailto:info.de@wago.com) | Web: [www.wago.com](http://www.wago.com)

Do you have any questions about our products?  
We are always happy to take your call at +49 (571) 887-44222.