

Data sheet | Item number: 857-800

Temperature signal conditioner for RTD sensors; Current and voltage output signal; Configuration via DIP switch; Supply voltage: 24 VDC; 6 mm module width; light gray

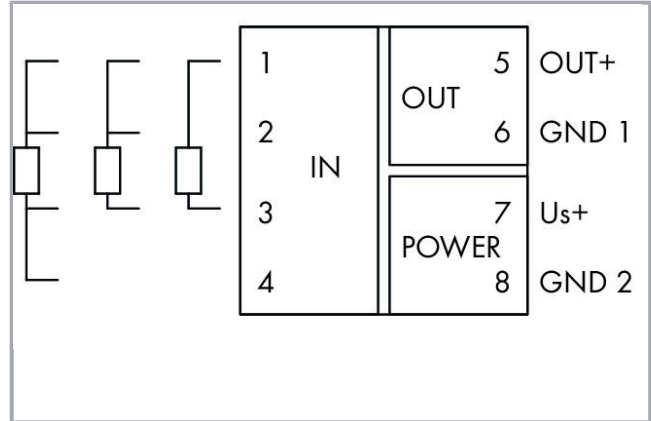

www.wago.com/857-800

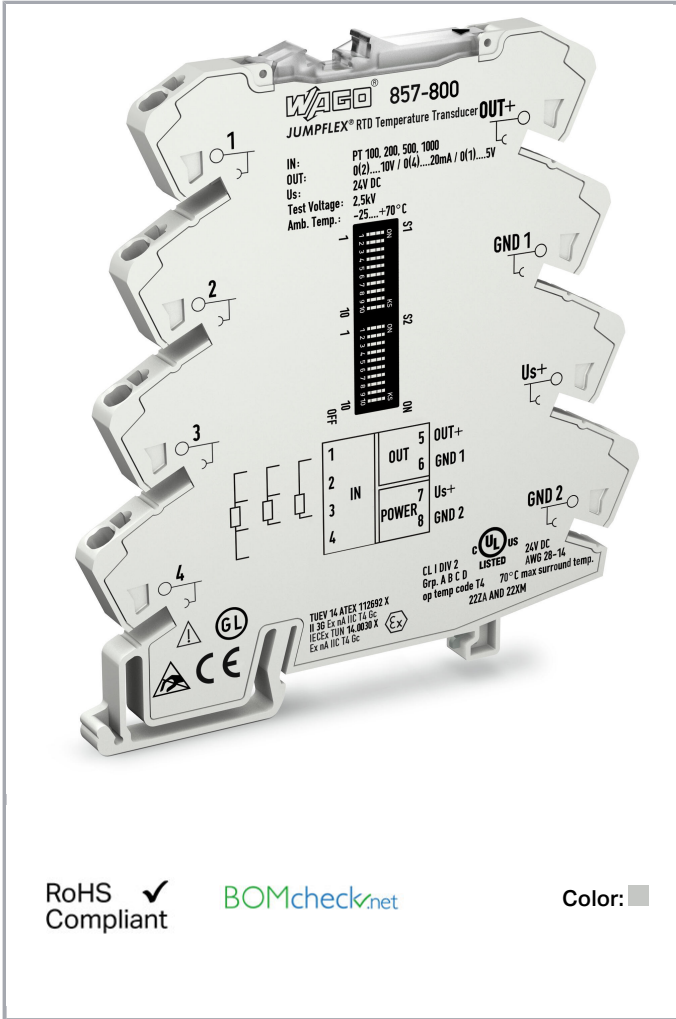

Subject to changes. Please also observe the further product documentation!

WAGO Kontakttechnik GmbH & Co. KG
Hansastr. 27
32423 Minden
Phone: +49571 887-0 | Fax: +49571 887-169
Email: info.de@wago.com | Web: www.wago.com

Do you have any questions about our products?
We are always happy to take your call at +49 (571) 887-44222.

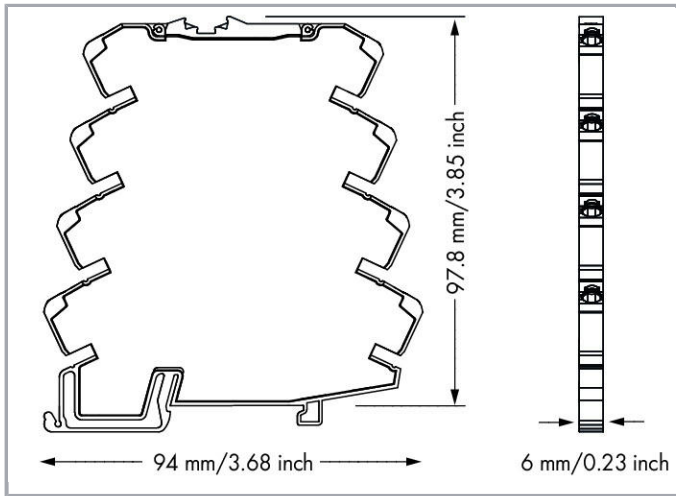

857-800
DIP Switch Adjustability

• = ON Default

DIP Switch S1

Wire Connection	Sensor Type	Output Signal	Measurement Range Underflow	Measurement Range Overflow	Wire Break	Short Circuit
2 Leiter	Pt100	0...20 mA	Lower limit of output range - 5 %*	Upper limit of output range + 2.5 %*	Upper limit of output range + 5 %*	Lower limit of output range - 2.5 %*
• 3 Leiter	• Pt200	• 4...20 mA	• Lower limit of output range	• Upper limit of output range + 2.5 %	• Upper limit of output range + 5 %	• Lower limit of output range
• 4 Leiter	• Pt500	• 0...10 mA	• Lower limit of output range	• Upper limit of output range + 2.5 %	• Upper limit of output range + 5 %	• Lower limit of output range
	• Pt1000	• 2...10 mA	• Lower limit of output range	• Upper limit of output range	• Upper limit of output range + 5 %	• Lower limit of output range + 5 %
	• 1 kΩ	• 0...10 V	• Lower limit of output range	• Upper limit of output range	• Upper limit of output range + 5 %	• Lower limit of output range + 5 %
	• 4.5 kΩ	• 2...10 V	• Lower limit of output range	• Upper limit of output range	• Lower limit of output range	• Lower limit of output range
		• 0...5 V	• Lower limit of output range	• Upper limit of output range	• Lower limit of output range	• Lower limit of output range
		• 1...5 V	• Lower limit of output range	• Upper limit of output range	• Lower limit of output range	• Lower limit of output range

DIP Switch S2

Start Temperature										End Temperature																																	
1	2	3	4	°C	°F	5	6	7	8	9	10	°C	°F	5	6	7	8	9	10	°C	°F	5	6	7	8	9	10	°C	°F														
•	•	•	•	0	32	•	•	•	•	•	•	100	212	•	•	•	•	•	•	•	•	•	•	75	167	•	•	•	•	•	•	210	410	•	•	•	•	•	•	•	•	475	887
•	•	•	•	-200	-328	•	•	•	•	•	•	0	32	•	•	•	•	•	•	•	•	•	•	80	176	•	•	•	•	•	•	220	428	•	•	•	•	•	•	•	•	500	932
•	•	•	•	-175	-283	•	•	•	•	•	•	5	41	•	•	•	•	•	•	•	•	•	•	85	185	•	•	•	•	•	•	230	446	•	•	•	•	•	•	•	•	525	997
•	•	•	•	-150	-238	•	•	•	•	•	•	10	50	•	•	•	•	•	•	•	•	•	•	90	194	•	•	•	•	•	•	240	464	•	•	•	•	•	•	•	•	550	1022
•	•	•	•	-125	-193	•	•	•	•	•	•	15	59	•	•	•	•	•	•	•	•	•	•	95	203	•	•	•	•	•	•	250	482	•	•	•	•	•	•	•	•	575	1067
•	•	•	•	-100	-148	•	•	•	•	•	•	20	68	•	•	•	•	•	•	•	•	•	•	100	212	•	•	•	•	•	•	260	500	•	•	•	•	•	•	•	•	600	1112
•	•	•	•	-90	-130	•	•	•	•	•	•	25	77	•	•	•	•	•	•	•	•	•	•	110	230	•	•	•	•	•	•	270	518	•	•	•	•	•	•	•	•	625	1157
•	•	•	•	-80	-112	•	•	•	•	•	•	30	86	•	•	•	•	•	•	•	•	•	•	120	248	•	•	•	•	•	•	280	536	•	•	•	•	•	•	•	•	650	1202
•	•	•	•	-70	-94	•	•	•	•	•	•	35	95	•	•	•	•	•	•	•	•	•	•	130	266	•	•	•	•	•	•	290	554	•	•	•	•	•	•	•	•	675	1247
•	•	•	•	-60	-76	•	•	•	•	•	•	40	104	•	•	•	•	•	•	•	•	•	•	140	284	•	•	•	•	•	•	300	572	•	•	•	•	•	•	•	•	700	1292
•	•	•	•	-50	-58	•	•	•	•	•	•	45	113	•	•	•	•	•	•	•	•	•	•	150	302	•	•	•	•	•	•	325	617	•	•	•	•	•	•	•	•	725	1337
•	•	•	•	-40	-40	•	•	•	•	•	•	50	122	•	•	•	•	•	•	•	•	•	•	160	320	•	•	•	•	•	•	350	652	•	•	•	•	•	•	•	•	750	1382
•	•	•	•	-30	-22	•	•	•	•	•	•	55	131	•	•	•	•	•	•	•	•	•	•	170	338	•	•	•	•	•	•	375	707	•	•	•	•	•	•	•	•	775	1427
•	•	•	•	-20	-4	•	•	•	•	•	•	60	140	•	•	•	•	•	•	•	•	•	•	180	356	•	•	•	•	•	•	400	752	•	•	•	•	•	•	•	•	800	1472
•	•	•	•	-10	14	•	•	•	•	•	•	65	149	•	•	•	•	•	•	•	•	•	•	190	374	•	•	•	•	•	•	425	797	•	•	•	•	•	•	•	•	825	1517
•	•	•	•	0	32	•	•	•	•	•	•	70	158	•	•	•	•	•	•	•	•	•	•	200	392	•	•	•	•	•	•	450	842	•	•	•	•	•	•	•	•	850	1562

*acc. to NAMUR NE 43

The minimum distance from the start temperature to the end temperature may not fall short of 50K degrees on the Celsius (C) scale or 122K degrees on the Fahrenheit (F) scale.

Item description

Short description:

This temperature signal conditioner records Pt100, Pt200, Pt500, and Pt1000 sensors, as well as resistors up to 4.5 kOhm, converting the temperature signal into a standard analog signal at the output.

Features:

- For Pt100, Pt200, Pt500 and Pt1000 sensors, as well as resistors up to 4.5 kOhm
- 2-, 3- and 4-wire connection technology
- Switching between measurement ranges is calibrated
- Detects a sensor wire break/short circuit
- Detects measurement range underflow/overflow
- Clipping capability for analog signal limitation to output end values
- Safe 3-way isolation with 2.5 kV test voltage per EN 61140

Data

Technical Data

Configuration

Configuration options

DIP switch

Input

Input signal type

Pt sensors

Resistor

Subject to changes. Please also observe the further product documentation!

WAGO Kontakttechnik GmbH & Co. KG

Hansastr. 27

32423 Minden

Phone: +49571 887-0 | Fax: +49571 887-169

Email: info.de@wago.com | Web: www.wago.com

Do you have any questions about our products?

We are always happy to take your call at +49 (571) 887-44222.

Input – RTD sensors

Sensor types (RTD)	Pt100 Pt200 Pt500 Pt1000
Sensor connection	2-wire; 3-wire; 4-wire (switchable)
Max. sensor supply current (RTD)	≤ 0,5 mA
Measurement range temperature (RTD)	-200 ... 850°C

Input – Resistors

Input range resistance	0 ... 1 kΩ; 0 ... 4,5 kΩ
------------------------	--------------------------

Output – Analog

Output signal type	Current Voltage
Output signal voltage	0 ... 5 V; 1 ... 5 V; 0 ... 10 V; 2 ... 10 V
Output signal current	0 ... 10 mA; 2 ... 10 mA; 0 ... 20 mA; 4 ... 20 mA
Load impedance (output/voltage)	≥ 2 kΩ
Load impedance (output/current)	≤ 600 Ω

Signal processing

Step response typ.	180 ms (2-wire); 360 ms (3-wire)
--------------------	----------------------------------

Measurement error

Transmission error typ.	≤ 0.1 % at full measurement span
Transmission error of set measurement range	≤ ((10 K/set measurement range [K]) + 0.1) %
Temperature coefficient	≤ 0.02 %/K

Power supply

Type of power supply	24 VDC
Nominal supply voltage U_S	DC 24 V
Supply voltage range	±30 %
Current consumption at supply voltage	≤ 40 mA

Safety and protection:

Test voltage (input/output/supply)	AC 2,5 kV; 50 Hz; 1 min
------------------------------------	-------------------------

Subject to changes. Please also observe the further product documentation!



Protection class	IP20
------------------	------

Connection data

Connection technology	Push-in CAGE CLAMP®
Solid conductor	0,08 ... 2,5 mm ² / 28 ... 14 AWG
Fine-stranded conductor	0,34 ... 2,5 mm ² / 22 ... 14 AWG
Strip length	9 ... 10 mm / 0.35 ... 0.39 inch

Geometrical Data

Width	6 mm / 0.236 inch
Height from upper-edge of DIN-35 rail	97,8 mm / 3.85 inch
Depth	94 mm / 3.701 inch

Mechanical data

Type of mounting	DIN-35 rail
------------------	-------------

Material Data

Color	light gray
Weight	35.3 g

Environmental Requirements

Surrounding air (operating) temperature	-25 ... 70 °C
Surrounding air (storage) temperature	-40 ... 85 °C

Standards and specifications

Conformity marking	CE
EMC immunity to interference	EN 61000-6-2
EMC emission of interference	EN 61000-6-4



Commercial data

Product Group	6 (Interface Electronics)
Packaging type	bag
Country of origin	DE
GTIN	4045454470128
Customs Tariff No.	85437090300



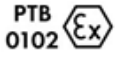

Subject to changes. Please also observe the further product documentation!

Approvals / Certificates

Ex-Approvals

Logo	Approval	Additional Approval Text	Certificate name
	IECEX TUEV Nord Cert GmbH	IEC 60079-0	IECEX_TUN_14.0030_X
	IECEX TUEV Nord Cert GmbH	EN 60079-0	TÜV_14_ATEX_112692_X
	UL UL International Germany GmbH (HAZARDOUS LOCATIONS)	ANSI/ISA 12.12.01	E198726 Sec.4

Ship Approvals

Logo	Approval	Additional Approval Text	Certificate name
	BV Bureau Veritas S.A.	-	40179_A0
	DNV GL Det Norske Veritas, Germanischer Lloyd	-	TAA00001D1
	NK Nippon Kaiji Kyokai	-	TA17255M
	PRS Polski Rejestr Statków	-	TE/2186 /880590/18

UL-Approvals

Logo	Approval	Additional Approval Text	Certificate name
	UL UL International Netherlands B.V. (ORDINARY LOCATIONS)	UL 508	E175199 Sec.4

Subject to changes. Please also observe the further product documentation!

Counterpart

Compatible products

tools

Item no.: 210-720 Operating tool; Blade: 3.5 x 0.5 mm; with a partially insulated shaft	www.wago.com/210-720
---	--

Jumper

Item no.: 281-482 Comb-style jumper bar; insulated; 2-way; IN = IN terminal block; gray	www.wago.com/281-482
---	--



Item no.: 859-402 Push-in type jumper bar; 2-way; Nominal current 18 A; insulated; light gray	www.wago.com/859-402
---	--



Item no.: 859-402/000-005 Push-in type jumper bar; 2-way; Nominal current 18 A; insulated; red	www.wago.com/859-402/000-005
--	--



Item no.: 859-402/000-006 Push-in type jumper bar; 2-way; Nominal current 18 A; insulated; blue	www.wago.com/859-402/000-006
---	--



Item no.: 859-402/000-029 Push-in type jumper bar; 2-way; Nominal current 18 A; insulated; yellow	www.wago.com/859-402/000-029
---	--



Item no.: 859-403 Push-in type jumper bar; 3-way; Nominal current 18 A; insulated; light gray	www.wago.com/859-403
---	--



Item no.: 859-403/000-005 Push-in type jumper bar; 3-way; Nominal current 18 A; insulated; red	www.wago.com/859-403/000-005
--	--

















Item no.: 859-403/000-006 Push-in type jumper bar; 3-way; Nominal current 18 A; insulated; blue	www.wago.com/859-403/000-006
---	--



Item no.: 859-403/000-029 Push-in type jumper bar; 3-way; Nominal current 18 A; insulated; yellow	www.wago.com/859-403/000-029
---	--

Subject to changes. Please also observe the further product documentation!

	Item no.: 859-404 Push-in type jumper bar; 4-way; Nominal current 18 A; insulated; light gray	www.wago.com/859-404
	Item no.: 859-404/000-005 Push-in type jumper bar; 4-way; Nominal current 18 A; insulated; red	www.wago.com/859-404/000-005
	Item no.: 859-404/000-006 Push-in type jumper bar; 4-way; Nominal current 18 A; insulated; blue	www.wago.com/859-404/000-006
	Item no.: 859-404/000-029 Push-in type jumper bar; 4-way; Nominal current 18 A; insulated; yellow	www.wago.com/859-404/000-029
	Item no.: 859-405 Push-in type jumper bar; 5-way; Nominal current 18 A; insulated; light gray	www.wago.com/859-405
	Item no.: 859-405/000-005 Push-in type jumper bar; 5-way; Nominal current 18 A; insulated; red	www.wago.com/859-405/000-005
	Item no.: 859-405/000-006 Push-in type jumper bar; 5-way; Nominal current 18 A; insulated; blue	www.wago.com/859-405/000-006
	Item no.: 859-405/000-029 Push-in type jumper bar; 5-way; Nominal current 18 A; insulated; yellow	www.wago.com/859-405/000-029
	Item no.: 859-406 Push-in type jumper bar; 6-way; Nominal current 18 A; insulated; light gray	www.wago.com/859-406
	Item no.: 859-406/000-005 Push-in type jumper bar; 6-way; Nominal current 18 A; insulated; red	www.wago.com/859-406/000-005
	Item no.: 859-406/000-006 Push-in type jumper bar; 6-way; Nominal current 18 A; insulated; blue	www.wago.com/859-406/000-006
	Item no.: 859-406/000-029 Push-in type jumper bar; 6-way; Nominal current 18 A; insulated; yellow	www.wago.com/859-406/000-029
	Item no.: 859-407 Push-in type jumper bar; 7-way; Nominal current 18 A; insulated; light gray	www.wago.com/859-407
	Item no.: 859-407/000-005 Push-in type jumper bar; 7-way; Nominal current 18 A; insulated; red	www.wago.com/859-407/000-005

Subject to changes. Please also observe the further product documentation!



Item no.: 859-407/000-006
Push-in type jumper bar; 7-way; Nominal current 18 A; insulated; blue

www.wago.com/859-407/000-006



Item no.: 859-407/000-029
Push-in type jumper bar; 7-way; Nominal current 18 A; insulated; yellow

www.wago.com/859-407/000-029



Item no.: 859-408
Push-in type jumper bar; 8-way; Nominal current 18 A; insulated; light gray

www.wago.com/859-408



Item no.: 859-408/000-005
Push-in type jumper bar; 8-way; Nominal current 18 A; insulated; red

www.wago.com/859-408/000-005



Item no.: 859-408/000-006
Push-in type jumper bar; 8-way; Nominal current 18 A; insulated; blue

www.wago.com/859-408/000-006



Item no.: 859-408/000-029
Push-in type jumper bar; 8-way; Nominal current 18 A; insulated; yellow

www.wago.com/859-408/000-029



Item no.: 859-409
Push-in type jumper bar; 9-way; Nominal current 18 A; insulated; light gray

www.wago.com/859-409

Item no.: 859-409/000-005
Push-in type jumper bar; 9-way; Nominal current 18 A; insulated; red

www.wago.com/859-409/000-005



Item no.: 859-409/000-006
Push-in type jumper bar; 9-way; Nominal current 18 A; insulated; blue

www.wago.com/859-409/000-006



Item no.: 859-409/000-029
Push-in type jumper bar; 9-way; Nominal current 18 A; insulated; yellow

www.wago.com/859-409/000-029



Item no.: 859-410
Push-in type jumper bar; 10-way; Nominal current 18 A; insulated; light gray

www.wago.com/859-410



Item no.: 859-410/000-005
Push-in type jumper bar; 10-way; Nominal current 18 A; insulated; red

www.wago.com/859-410/000-005

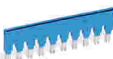

Item no.: 859-410/000-006
Push-in type jumper bar; 10-way; Nominal current 18 A; insulated; blue

www.wago.com/859-410/000-006



Item no.: 859-410/000-029
Push-in type jumper bar; 10-way; Nominal current 18 A; insulated; yellow

www.wago.com/859-410/000-029

transfer module

Subject to changes. Please also observe the further product documentation!



Item no.: 857-980
Interface adapter; 16-pole; analog

www.wago.com/857-980

Marking accessories



Item no.: 2009-110
Marking strips; on reel; not stretchable; plain; snap-on type; white

www.wago.com/2009-110

Item no.: 2009-115
WMB-Inline; for Smart Printer; 1500 pieces on roll; stretchable 5 - 5.2 mm; plain; snap-on type; white

www.wago.com/2009-115

Item no.: 2009-115/000-002
WMB-Inline; for Smart Printer; 1500 pieces on roll; stretchable 5 - 5.2 mm; plain; snap-on type; yellow

www.wago.com/2009-115/000-002



Item no.: 2009-115/000-006
WMB-Inline; for Smart Printer; 1500 pieces on roll; stretchable 5 - 5.2 mm; plain; snap-on type; white

www.wago.com/2009-115/000-006



Item no.: 2009-115/000-007
WMB-Inline; for Smart Printer; 1500 pieces on roll; stretchable 5 - 5.2 mm; plain; snap-on type; gray

www.wago.com/2009-115/000-007

Item no.: 2009-115/000-012
WMB-Inline; for Smart Printer; 1500 pieces on roll; stretchable 5 - 5.2 mm; plain; snap-on type; white

www.wago.com/2009-115/000-012

Item no.: 2009-115/000-017
WMB-Inline; for Smart Printer; 1500 pieces on roll; stretchable 5 - 5.2 mm; plain; snap-on type; white

www.wago.com/2009-115/000-017

Item no.: 2009-115/000-023
WMB-Inline; for Smart Printer; 1500 pieces on roll; stretchable 5 - 5.2 mm; plain; snap-on type; green

www.wago.com/2009-115/000-023



Item no.: 2009-115/000-024
WMB-Inline; for Smart Printer; 1500 pieces on roll; stretchable 5 - 5.2 mm; plain; snap-on type; white

www.wago.com/2009-115/000-024



Item no.: 793-501
WMB marking card; as card; not stretchable; plain; snap-on type; white

www.wago.com/793-501



Item no.: 793-501/000-002
WMB marking card; as card; not stretchable; plain; snap-on type; yellow

www.wago.com/793-501/000-002

Item no.: 793-501/000-005
WMB marking card; as card; not stretchable; plain; snap-on type; red

www.wago.com/793-501/000-005



Item no.: 793-501/000-006
WMB marking card; as card; not stretchable; plain; snap-on type; blue

www.wago.com/793-501/000-006

Subject to changes. Please also observe the further product documentation!



Item no.: 793-501/000-007
WMB marking card; as card; not stretchable; plain; snap-on type; gray

www.wago.com/793-501/000-007



Item no.: 793-501/000-012
WMB marking card; as card; not stretchable; plain; snap-on type; orange

www.wago.com/793-501/000-012



Item no.: 793-501/000-017
WMB marking card; as card; not stretchable; plain; snap-on type; light green

www.wago.com/793-501/000-017



Item no.: 793-501/000-023
WMB marking card; as card; not stretchable; plain; snap-on type; green

www.wago.com/793-501/000-023

Item no.: 793-501/000-024
WMB marking card; as card; not stretchable; plain; snap-on type; violet

www.wago.com/793-501/000-024



Item no.: 793-502
WMB marking card; as card; MARKED; 1 ... 10 (10x); not stretchable; Horizontal marking; snap-on type; white

www.wago.com/793-502



Item no.: 793-502/000-002
WMB marking card; as card; MARKED; 1 ... 10 (10x); not stretchable; Horizontal marking; snap-on type; yellow

www.wago.com/793-502/000-002

Item no.: 793-502/000-005
WMB marking card; as card; MARKED; 1 ... 10 (10x); not stretchable; Horizontal marking; snap-on type; red

www.wago.com/793-502/000-005

Item no.: 793-502/000-006
WMB marking card; as card; MARKED; 1 ... 10 (10x); not stretchable; Horizontal marking; snap-on type; blue

www.wago.com/793-502/000-006

Item no.: 793-502/000-007
WMB marking card; as card; MARKED; 1 ... 10 (10x); not stretchable; Horizontal marking; snap-on type; gray

www.wago.com/793-502/000-007



Item no.: 793-502/000-012
WMB marking card; as card; MARKED; 1 ... 10 (10x); not stretchable; Horizontal marking; snap-on type; orange

www.wago.com/793-502/000-012



Item no.: 793-502/000-017
WMB marking card; as card; MARKED; 1 ... 10 (10x); not stretchable; Horizontal marking; snap-on type; light green

www.wago.com/793-502/000-017



Item no.: 793-502/000-023
WMB marking card; as card; MARKED; 1 ... 10 (10x); not stretchable; Horizontal marking; snap-on type; green

www.wago.com/793-502/000-023

Item no.: 793-502/000-024
WMB marking card; as card; MARKED; 1 ... 10 (10x); not stretchable; Horizontal marking; snap-on type;

www.wago.com/793-502/000-024

Subject to changes. Please also observe the further product documentation!

violet

Item no.: 793-503

WMB marking card; as card; MARKED; 11 ... 20 (10x); not stretchable; Horizontal marking; snap-on type; www.wago.com/793-503
white

Item no.: 793-503/000-002

WMB marking card; as card; MARKED; 11 ... 20 (10x); not stretchable; Horizontal marking; snap-on type; www.wago.com/793-503/000-002
yellow

Item no.: 793-503/000-005

WMB marking card; as card; MARKED; 11 ... 20 (10x); not stretchable; Horizontal marking; snap-on type; www.wago.com/793-503/000-005
red

Item no.: 793-503/000-006

WMB marking card; as card; MARKED; 11 ... 20 (10x); not stretchable; Horizontal marking; snap-on type; www.wago.com/793-503/000-006
blue

Item no.: 793-503/000-007

WMB marking card; as card; MARKED; 11 ... 20 (10x); not stretchable; Horizontal marking; snap-on type; www.wago.com/793-503/000-007
gray

Item no.: 793-503/000-012

WMB marking card; as card; MARKED; 11 ... 20 (10x); not stretchable; Horizontal marking; snap-on type; www.wago.com/793-503/000-012
orange

Item no.: 793-503/000-017

WMB marking card; as card; MARKED; 11 ... 20 (10x); not stretchable; Horizontal marking; snap-on type; www.wago.com/793-503/000-017
light green

Item no.: 793-503/000-023

WMB marking card; as card; MARKED; 11 ... 20 (10x); not stretchable; Horizontal marking; snap-on type; www.wago.com/793-503/000-023
green



Item no.: 793-503/000-024

WMB marking card; as card; MARKED; 11 ... 20 (10x); not stretchable; Horizontal marking; snap-on type; www.wago.com/793-503/000-024
violet



Item no.: 793-504

WMB marking card; as card; MARKED; 21 ... 30 (10x); not stretchable; Horizontal marking; snap-on type; www.wago.com/793-504
white



Item no.: 793-504/000-002

WMB marking card; as card; MARKED; 21 ... 30 (10x); not stretchable; Horizontal marking; snap-on type; www.wago.com/793-504/000-002
yellow



Item no.: 793-504/000-005

WMB marking card; as card; MARKED; 21 ... 30 (10x); not stretchable; Horizontal marking; snap-on type; www.wago.com/793-504/000-005
red



Item no.: 793-504/000-006

WMB marking card; as card; MARKED; 21 ... 30 (10x); not stretchable; Horizontal marking; snap-on type; www.wago.com/793-504/000-006
blue

Item no.: 793-504/000-012

Subject to changes. Please also observe the further product documentation!

WAGO Kontakttechnik GmbH & Co. KG

Hansastr. 27















32423 Minden

Phone: +49571 887-0 | Fax: +49571 887-169











Email: info.de@wago.com | Web: www.wago.com

Do you have any questions about our products?

We are always happy to take your call at +49 (571) 887-44222.

	WMB marking card; as card; MARKED; 21 ... 30 (10x); not stretchable; Horizontal marking; snap-on type; orange	www.wago.com/793-504/000-012
	Item no.: 793-504/000-017 WMB marking card; as card; MARKED; 21 ... 30 (10x); not stretchable; Horizontal marking; snap-on type; light green	www.wago.com/793-504/000-017
	Item no.: 793-504/000-023 WMB marking card; as card; MARKED; 21 ... 30 (10x); not stretchable; Horizontal marking; snap-on type; green	www.wago.com/793-504/000-023
	Item no.: 793-505 WMB marking card; as card; MARKED; 31 ... 40 (10x); not stretchable; Horizontal marking; snap-on type; white	www.wago.com/793-505
	Item no.: 793-505/000-005 WMB marking card; as card; MARKED; 31 ... 40 (10x); not stretchable; Horizontal marking; snap-on type; red	www.wago.com/793-505/000-005
	Item no.: 793-505/000-006 WMB marking card; as card; MARKED; 31 ... 40 (10x); not stretchable; Horizontal marking; snap-on type; blue	www.wago.com/793-505/000-006
	Item no.: 793-505/000-007 WMB marking card; as card; MARKED; 31 ... 40 (10x); not stretchable; Horizontal marking; snap-on type; gray	www.wago.com/793-505/000-007
	Item no.: 793-505/000-012 WMB marking card; as card; MARKED; 31 ... 40 (10x); not stretchable; Horizontal marking; snap-on type; orange	www.wago.com/793-505/000-012
	Item no.: 793-506 WMB marking card; as card; MARKED; 41 ... 50 (10x); not stretchable; Horizontal marking; snap-on type; white	www.wago.com/793-506
	Item no.: 793-506/000-005 WMB marking card; as card; MARKED; 41 ... 50 (10x); not stretchable; Horizontal marking; snap-on type; red	www.wago.com/793-506/000-005
	Item no.: 793-506/000-006 WMB marking card; as card; MARKED; 41 ... 50 (10x); not stretchable; Horizontal marking; snap-on type; blue	www.wago.com/793-506/000-006
	Item no.: 793-506/000-012 WMB marking card; as card; MARKED; 41 ... 50 (10x); not stretchable; Horizontal marking; snap-on type; orange	www.wago.com/793-506/000-012
	Item no.: 793-506/000-017 WMB marking card; as card; MARKED; 41 ... 50 (10x); not stretchable; Horizontal marking; snap-on type; light green	www.wago.com/793-506/000-017
	Item no.: 793-5501 WMB marking card; as card; for terminal block width 5 - 17.5 mm; stretchable 5 - 5.2 mm; plain; snap-on type; white	www.wago.com/793-5501

Subject to changes. Please also observe the further product documentation!

	<p>Item no.: 793-5501/000-002 WMB marking card; as card; for terminal block width 5 - 17.5 mm; stretchable 5 - 5.2 mm; plain; snap-on type; yellow</p>	www.wago.com/793-5501/000-002
	<p>Item no.: 793-5501/000-005 WMB marking card; as card; for terminal block width 5 - 17.5 mm; stretchable 5 - 5.2 mm; plain; snap-on type; red</p>	www.wago.com/793-5501/000-005
	<p>Item no.: 793-5501/000-006 WMB marking card; as card; for terminal block width 5 - 17.5 mm; stretchable 5 - 5.2 mm; plain; snap-on type; blue</p>	www.wago.com/793-5501/000-006
	<p>Item no.: 793-5501/000-007 WMB marking card; as card; for terminal block width 5 - 17.5 mm; stretchable 5 - 5.2 mm; plain; snap-on type; gray</p>	www.wago.com/793-5501/000-007
	<p>Item no.: 793-5501/000-012 WMB marking card; as card; for terminal block width 5 - 17.5 mm; stretchable 5 - 5.2 mm; plain; snap-on type; orange</p>	www.wago.com/793-5501/000-012
	<p>Item no.: 793-5501/000-014 WMB marking card; as card; for terminal block width 5 - 17.5 mm; stretchable 5 - 5.2 mm; plain; snap-on type; brown</p>	www.wago.com/793-5501/000-014
	<p>Item no.: 793-5501/000-017 WMB marking card; as card; for terminal block width 5 - 17.5 mm; stretchable 5 - 5.2 mm; plain; snap-on type; green</p>	www.wago.com/793-5501/000-017
	<p>Item no.: 793-5501/000-023 WMB marking card; as card; for terminal block width 5 - 17.5 mm; stretchable 5 - 5.2 mm; plain; snap-on type; light green</p>	www.wago.com/793-5501/000-023
	<p>Item no.: 793-5501/000-024 WMB marking card; as card; for terminal block width 5 - 17.5 mm; stretchable 5 - 5.2 mm; plain; snap-on type; violet</p>	www.wago.com/793-5501/000-024
	<p>Item no.: 793-566 WMB marking card; as card; MARKED; 1 ... 50 (2x); not stretchable; Horizontal marking; snap-on type; white</p>	www.wago.com/793-566
	<p>Item no.: 793-566/000-002 WMB marking card; as card; MARKED; 1 ... 50 (2x); not stretchable; Horizontal marking; snap-on type; yellow</p>	www.wago.com/793-566/000-002
	<p>Item no.: 793-566/000-005 WMB marking card; as card; MARKED; 1 ... 50 (2x); not stretchable; Horizontal marking; snap-on type; red</p>	www.wago.com/793-566/000-005
	<p>Item no.: 793-566/000-006 WMB marking card; as card; MARKED; 1 ... 50 (2x); not stretchable; Horizontal marking; snap-on type; blue</p>	www.wago.com/793-566/000-006
	<p>Item no.: 793-566/000-007 WMB marking card; as card; MARKED; 1 ... 50 (2x); not stretchable; Horizontal marking; snap-on type;</p>	

Subject to changes. Please also observe the further product documentation!



gray

www.wago.com/793-566/000-007
**Item no.: 793-566/000-012**

WMB marking card; as card; MARKED; 1 ... 50 (2x); not stretchable; Horizontal marking; snap-on type; orange

www.wago.com/793-566/000-012
**Item no.: 793-566/000-017**

WMB marking card; as card; MARKED; 1 ... 50 (2x); not stretchable; Horizontal marking; snap-on type; light green

www.wago.com/793-566/000-017
**Item no.: 793-566/000-023**

WMB marking card; as card; MARKED; 1 ... 50 (2x); not stretchable; Horizontal marking; snap-on type; green

www.wago.com/793-566/000-023
**Item no.: 793-566/000-024**

WMB marking card; as card; MARKED; 1 ... 50 (2x); not stretchable; Horizontal marking; snap-on type; violet

www.wago.com/793-566/000-024

power supply

**Item no.: 787-2852**

Switched-mode power supply; for JUMPFLEX® Signal Conditioners; 1-phase; 24 VDC output voltage; 1 A output current; -

www.wago.com/787-2852

assembling

**Item no.: 249-116**

Screwless end stop; 6 mm wide; for DIN-rail 35 x 15 and 35 x 7.5; gray

www.wago.com/249-116
**Item no.: 249-117**

Screwless end stop; 10 mm wide; for DIN-rail 35 x 15 and 35 x 7.5; gray

www.wago.com/249-117
**Item no.: 249-197**

Screwless end stop; 14 mm wide; for DIN-rail 35 x 15 and 35 x 7.5; gray

www.wago.com/249-197

General accessories

**Item no.: 857-979**Supply and through module; 2,50 mm²
www.wago.com/857-979

Downloads

Documentation

Instruction Leaflet

Messumformer und Trennverstärker
 TemperaturmessumformerPt100, Pt200, Pt500, Pt1000, Widerstände 0 ... 1 kOhm, 0 ... 4,5 kOhm DIP-Schalter

pdf
 2.2 MB
[Download](#)

Additional Information

Disposal; Electrical and electronic equipment, Packaging

Subject to changes. Please also observe the further product documentation!

WAGO Kontakttechnik GmbH & Co. KG
 Hansastr. 27
 32423 Minden
 Phone: +49571 887-0 | Fax: +49571 887-169
 Email: info.de@wago.com | Web: www.wago.com

Do you have any questions about our products?
 We are always happy to take your call at +49 (571) 887-44222.

V 1.0.0

pdf
265.8 kB

Download

Step Datei Serie 857-08xx

1.0
Jun 20, 2011

ifc
348.4 kB

Download

CAD/CAE-Data

CAD data

2D/3D Models 857-800

URL

Download

CAE data

EPLAN Data Portal 857-800

URL

Download

WSCAD Universe 857-800

URL

Download

Installation Notes

Configuring

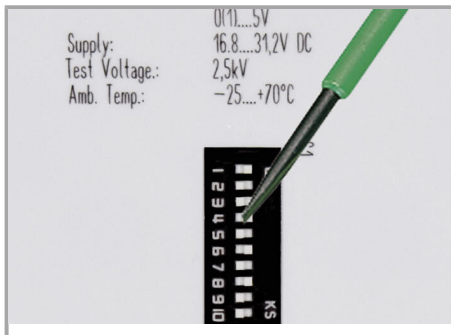

Configuration via DIP switches

Commoning

Subject to changes. Please also observe the further product documentation!

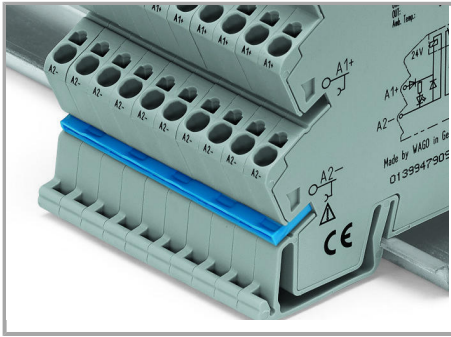

Commoning, not discrete wiring – same outline allows the use of a single in-line, push-in jumper

Subject to changes. Please also observe the further product documentation!

WAGO Kontakttechnik GmbH & Co. KG
Hansastr. 27
32423 Minden
Phone: +49571 887-0 | Fax: +49571 887-169
Email: info.de@wago.com | Web: www.wago.com

Do you have any questions about our products?
We are always happy to take your call at +49 (571) 887-44222.