

Data sheet | Item number: 857-357

Relay module; Nominal input voltage: 115 V AC/DC; 1 changeover contact;
Limiting continuous current: 6 A; Yellow status indicator; Module width: 6
mm; 2,50 mm²; gray

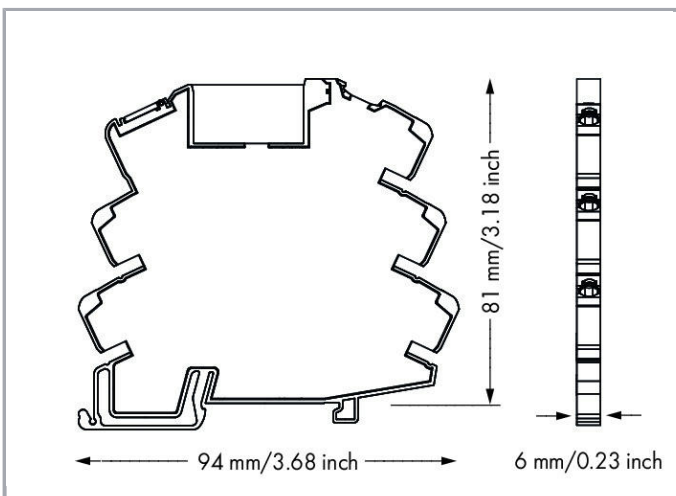

www.wago.com/857-357

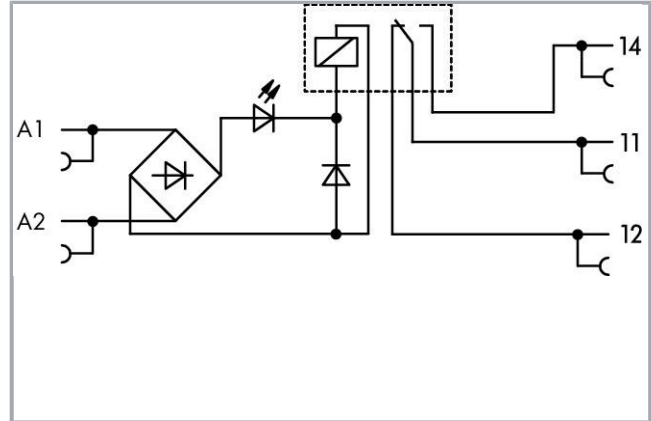
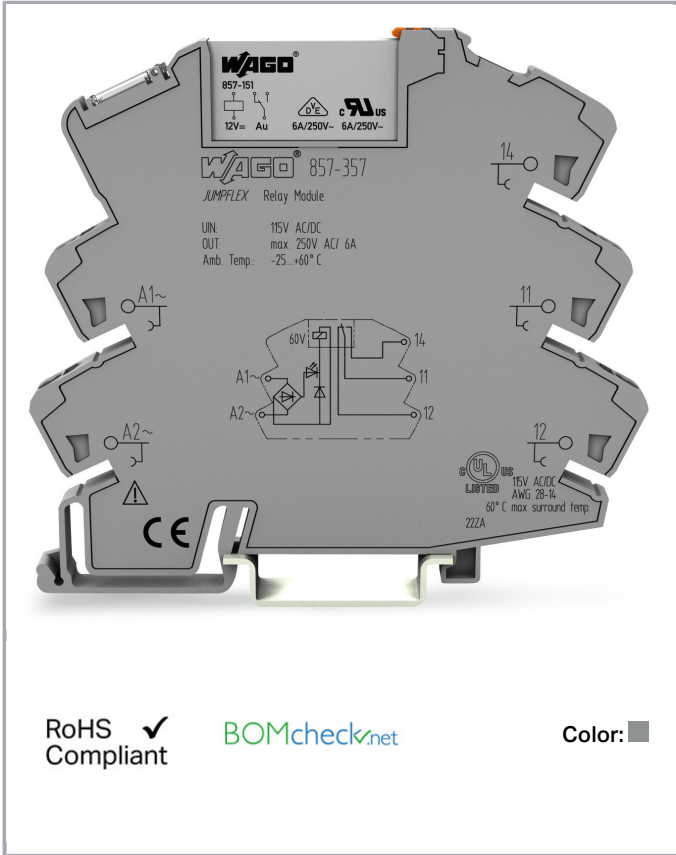

Subject to changes. Please also observe the further product documentation!

WAGO Kontakttechnik GmbH & Co. KG
Hansastr. 27
32423 Minden
Phone: +49571 887-0 | Fax: +49571 887-169
Email: info.de@wago.com | Web: www.wago.com

Do you have any questions about our products?
We are always happy to take your call at +49 (571) 887-44222.

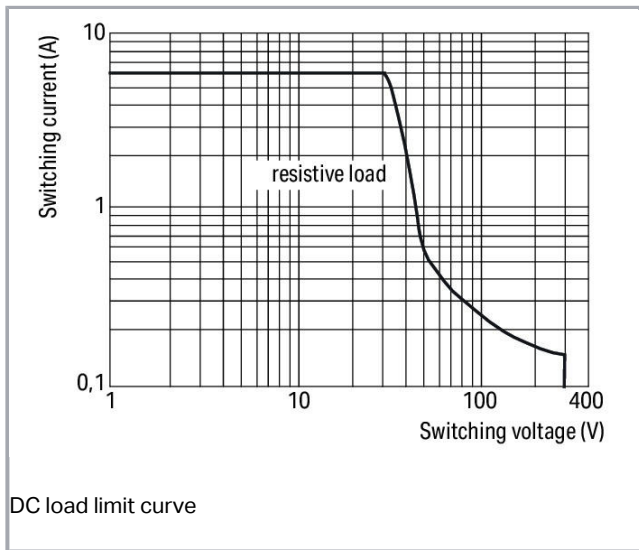

Item description

Note:

To protect the relay coils and contacts, inductive loads must be dampened with an effective protection circuit.

Data

Technical Data

Control circuit

| | |
|--------------------------------|-------------|
| Nominal input voltage U_N | AC/DC 115 V |
| Input voltage range | $\pm 20\%$ |
| Nominal input current at U_N | 4 mA |

Load circuit:

| | |
|------------------------------------------|---------------------------------------------|
| Number of changeover/switchover contacts | 1 |
| Contact material (relay) | AgSnO ₂ |
| Limiting continuous current | 6 A |
| Max. make current (resistive) | (AC) 20 A / 0,02 s |
| Max. switching voltage | AC 250 V |
| Max. switching power (resistive) | AC 1500 VA; DC (see load limit curve) |
| Switching capacity | AC-15: 3 A / AC 250 V; DC-13: 2 A / DC 24 V |

Subject to changes. Please also observe the further product documentation!



| | |
|-----------------------------------------------|---------------------------------------------|
| Recommended minimum load | 10 V / 10 mA; 24 V / 1 mA |
| Pull-in time (typ.) | 15 ms |
| Drop-out time (typ.) | 25 ms |
| Bounce time (typ.) | 3.5 ms |
| Electrical life (N.O.; resistive load; 23 °C) | 50 x 10 ³ switching operations |
| Mechanical life | 5 x 10 ⁶ switching operations |
| Max. switching load with load/without load | 6 min ⁻¹ / 180 min ⁻¹ |

Signaling

| | |
|-------------------|------------|
| Status indication | Yellow LED |
|-------------------|------------|

Safety and protection:

| | |
|-------------------------------------------------------|---------|
| Rated voltage | 250 V |
| Rated impulse voltage | 4 kV |
| Pollution degree | 2 |
| Dielectric strength, control/load circuit (AC, 1 min) | 4 kVrms |
| Dielectric strength open contact (AC, 1 min) | 1 kVrms |
| Protection class | IP20 |

Connection data

| | |
|-------------------------|----------------------------------------------|
| Connection technology | Push-in CAGE CLAMP® |
| Solid conductor | 0,34 ... 2,5 mm ² / 22 ... 14 AWG |
| Fine-stranded conductor | 0,34 ... 2,5 mm ² / 22 ... 14 AWG |
| Strip length | 9 ... 10 mm / 0.35 ... 0.39 inch |

Geometrical Data

| | |
|---------------------------------------|--------------------|
| Width | 6 mm / 0.236 inch |
| Height from upper-edge of DIN-35 rail | 81 mm / 3.189 inch |
| Depth | 94 mm / 3.701 inch |

Mechanical data

| | |
|------------------|-------------|
| Type of mounting | DIN-35 rail |
|------------------|-------------|

Material Data

| | |
|-------|------|
| Color | gray |
|-------|------|

Subject to changes. Please also observe the further product documentation!

| | |
|-----------|----------|
| Fire load | 0.011 MJ |
| Weight | 32.2 g |

Environmental Requirements

| | |
|-----------------------------------------------------------|----------------|
| Surrounding air (operating) temperature at U _N | -40 ... 60 °C |
| Surrounding air (storage) temperature | -40 ... 70 °C |
| Processing temperature | -25 ... +50 °C |

Standards and specifications

| | |
|--------------------------|------------------------------------------------------------|
| Standards/specifications | EN 61010-2-201; EN 61810-1; EN 61373; UL 508; ATEX; IEC Ex |
|--------------------------|------------------------------------------------------------|

Elementary relay



| | |
|-----------------------|---------|
| WAGO elementary relay | 857-155 |
|-----------------------|---------|

Commercial data

| | |
|--------------------|---------------------------|
| Product Group | 6 (Interface Electronics) |
| Packaging type | BOX |
| Country of origin | CN |
| GTIN | 4045454694029 |
| Customs Tariff No. | 85364900990 |

Approvals / Certificates

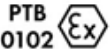
Ex-Approvals

| Logo | Approval | Additional Approval Text | Certificate name |
|------------------------------------------------------------------------------------|-----------------------------------------------------------|--------------------------|---------------------|
|  | ATEX DEKRA EXAM GmbH | EN 60079-0 | BVS_14_ATEX_E_091_X |
|  | IECEX DEKRA EXAM GmbH | IEC 60079-0 | IECEX_BVS_14.0079_X |
|  | UL UL International Germany GmbH (HAZARDOUS LOCATIONS) | ANSI/ISA 12.12.01 | E198726 Sec.4 |

UL-Approvals

Subject to changes. Please also observe the further product documentation!

WAGO Kontakttechnik GmbH & Co. KG
 Hansastr. 27
 32423 Minden
 Phone: +49571 887-0 | Fax: +49571 887-169
 Email: info.de@wago.com | Web: www.wago.com

Do you have any questions about our products?
 We are always happy to take your call at +49 (571) 887-44222.

| Logo | Approval | Additional Approval Text | Certificate name |
|----------------------------------------------------------------------------------|--------------------------------------------------------------|--------------------------|------------------|
|  | UL UL International Netherlands B.V. (ORDINARY LOCATIONS) | UL 508 | E175199 Sec.4 |

Counterpart

Compatible products

General accessories

| | |
|--------------------------------------------------------------------------------------------------------------------------------------------------------------------------|----------------------------------------------------------------|
| Item no.: 209-184 Protection cover; transparent | www.wago.com/209-184 |
| Item no.: 857-155 Basic relay; Nominal input voltage: 60 VDC; 1 changeover contact; Limiting continuous current: 6 A; Module width: 5 mm; Module height: 15 mm | www.wago.com/857-155 |



ferrule

| | |
|---------------------------------------------------------------------------------------------------------------------------------------------------------------------------------------------------------------------------------------------------------------------------|----------------------------------------------------------------|
| Item no.: 216-241 Ferrule; Sleeve for 0.5 mm ² / 20 AWG; insulated; electro-tin plated; electrolytic copper; gastight crimped; acc. to DIN 46228, Part 4/09.90; white | www.wago.com/216-241 |
| Item no.: 216-242 Ferrule; Sleeve for 0.75 mm ² / 18 AWG; insulated; electro-tin plated; electrolytic copper; gastight crimped; acc. to DIN 46228, Part 4/09.90; gray | www.wago.com/216-242 |
|  Item no.: 216-243 Ferrule; Sleeve for 1 mm ² / AWG 18; insulated; electro-tin plated; electrolytic copper; gastight crimped; acc. to DIN 46228, Part 4/09.90; red | www.wago.com/216-243 |
| Item no.: 216-244 Ferrule; Sleeve for 1.5 mm ² / AWG 16; insulated; electro-tin plated; electrolytic copper; gastight crimped; acc. to DIN 46228, Part 4/09.90; black | www.wago.com/216-244 |













tools

| | |
|---------------------------------------------------------------------------------------------------|----------------------------------------------------------------|
| Item no.: 210-720 Operating tool; Blade: 3.5 x 0.5 mm; with a partially insulated shaft | www.wago.com/210-720 |
|---------------------------------------------------------------------------------------------------|----------------------------------------------------------------|









Jumper

| | |
|--------------------------------------------------------------------------------------------------------------------------------------------------------------------------------------------|----------------------------------------------------------------|
|  Item no.: 281-482 Comb-style jumper bar; insulated; 2-way; IN = IN terminal block; gray | www.wago.com/281-482 |
|  Item no.: 859-402 Push-in type jumper bar; 2-way; Nominal current 18 A; insulated; light gray | www.wago.com/859-402 |

Subject to changes. Please also observe the further product documentation!

| | | |
|------------------------------------------------------------------------------------|-------------------------------------------------------------------------------------------------------------|--------------------------------------------------------------------------------|
|  | Item no.: 859-402/000-005 Push-in type jumper bar; 2-way; Nominal current 18 A; insulated; red | www.wago.com/859-402/000-005 |
|  | Item no.: 859-402/000-006 Push-in type jumper bar; 2-way; Nominal current 18 A; insulated; blue | www.wago.com/859-402/000-006 |
|  | Item no.: 859-402/000-029 Push-in type jumper bar; 2-way; Nominal current 18 A; insulated; yellow | www.wago.com/859-402/000-029 |
| | Item no.: 859-403 Push-in type jumper bar; 3-way; Nominal current 18 A; insulated; light gray | www.wago.com/859-403 |
|  | Item no.: 859-403/000-005 Push-in type jumper bar; 3-way; Nominal current 18 A; insulated; red | www.wago.com/859-403/000-005 |
|  | Item no.: 859-403/000-006 Push-in type jumper bar; 3-way; Nominal current 18 A; insulated; blue | www.wago.com/859-403/000-006 |
|  | Item no.: 859-403/000-029 Push-in type jumper bar; 3-way; Nominal current 18 A; insulated; yellow | www.wago.com/859-403/000-029 |
|  | Item no.: 859-404 Push-in type jumper bar; 4-way; Nominal current 18 A; insulated; light gray | www.wago.com/859-404 |
|  | Item no.: 859-404/000-005 Push-in type jumper bar; 4-way; Nominal current 18 A; insulated; red | www.wago.com/859-404/000-005 |
|  | Item no.: 859-404/000-006 Push-in type jumper bar; 4-way; Nominal current 18 A; insulated; blue | www.wago.com/859-404/000-006 |
|  | Item no.: 859-404/000-029 Push-in type jumper bar; 4-way; Nominal current 18 A; insulated; yellow | www.wago.com/859-404/000-029 |
|  | Item no.: 859-405 Push-in type jumper bar; 5-way; Nominal current 18 A; insulated; light gray | www.wago.com/859-405 |
|  | Item no.: 859-405/000-005 Push-in type jumper bar; 5-way; Nominal current 18 A; insulated; red | www.wago.com/859-405/000-005 |
|  | Item no.: 859-405/000-006 Push-in type jumper bar; 5-way; Nominal current 18 A; insulated; blue | www.wago.com/859-405/000-006 |

Subject to changes. Please also observe the further product documentation!

| | | |
|------------------------------------------------------------------------------------|-------------------------------------------------------------------------------------------------------------|--------------------------------------------------------------------------------|
|  | Item no.: 859-405/000-029 Push-in type jumper bar; 5-way; Nominal current 18 A; insulated; yellow | www.wago.com/859-405/000-029 |
| | Item no.: 859-406 Push-in type jumper bar; 6-way; Nominal current 18 A; insulated; light gray | www.wago.com/859-406 |
|  | Item no.: 859-406/000-005 Push-in type jumper bar; 6-way; Nominal current 18 A; insulated; red | www.wago.com/859-406/000-005 |
|  | Item no.: 859-406/000-006 Push-in type jumper bar; 6-way; Nominal current 18 A; insulated; blue | www.wago.com/859-406/000-006 |
|  | Item no.: 859-406/000-029 Push-in type jumper bar; 6-way; Nominal current 18 A; insulated; yellow | www.wago.com/859-406/000-029 |
|  | Item no.: 859-407 Push-in type jumper bar; 7-way; Nominal current 18 A; insulated; light gray | www.wago.com/859-407 |
| | Item no.: 859-407/000-005 Push-in type jumper bar; 7-way; Nominal current 18 A; insulated; red | www.wago.com/859-407/000-005 |
| | Item no.: 859-407/000-006 Push-in type jumper bar; 7-way; Nominal current 18 A; insulated; blue | www.wago.com/859-407/000-006 |
|  | Item no.: 859-407/000-029 Push-in type jumper bar; 7-way; Nominal current 18 A; insulated; yellow | www.wago.com/859-407/000-029 |
| | Item no.: 859-408 Push-in type jumper bar; 8-way; Nominal current 18 A; insulated; light gray | www.wago.com/859-408 |
|  | Item no.: 859-408/000-005 Push-in type jumper bar; 8-way; Nominal current 18 A; insulated; red | www.wago.com/859-408/000-005 |
| | Item no.: 859-408/000-006 Push-in type jumper bar; 8-way; Nominal current 18 A; insulated; blue | www.wago.com/859-408/000-006 |
|  | Item no.: 859-408/000-029 Push-in type jumper bar; 8-way; Nominal current 18 A; insulated; yellow | www.wago.com/859-408/000-029 |
|  | Item no.: 859-409 Push-in type jumper bar; 9-way; Nominal current 18 A; insulated; light gray | www.wago.com/859-409 |
| | Item no.: 859-409/000-005 Push-in type jumper bar; 9-way; Nominal current 18 A; insulated; red | www.wago.com/859-409/000-005 |

Subject to changes. Please also observe the further product documentation!

**Item no.: 859-409/000-006**

Push-in type jumper bar; 9-way; Nominal current 18 A; insulated; blue

www.wago.com/859-409/000-006**Item no.: 859-409/000-029**

Push-in type jumper bar; 9-way; Nominal current 18 A; insulated; yellow

www.wago.com/859-409/000-029**Item no.: 859-410**

Push-in type jumper bar; 10-way; Nominal current 18 A; insulated; light gray

www.wago.com/859-410**Item no.: 859-410/000-005**

Push-in type jumper bar; 10-way; Nominal current 18 A; insulated; red

www.wago.com/859-410/000-005**Item no.: 859-410/000-006**

Push-in type jumper bar; 10-way; Nominal current 18 A; insulated; blue

www.wago.com/859-410/000-006**Item no.: 859-410/000-029**

Push-in type jumper bar; 10-way; Nominal current 18 A; insulated; yellow

www.wago.com/859-410/000-029**Marking accessories****Item no.: 2009-110**

Marking strips; on reel; not stretchable; plain; snap-on type; white

www.wago.com/2009-110**Item no.: 2009-115**

WMB-Inline; for Smart Printer; 1500 pieces on roll; stretchable 5 - 5.2 mm; plain; snap-on type; white

www.wago.com/2009-115**Item no.: 2009-115/000-002**

WMB-Inline; for Smart Printer; 1500 pieces on roll; stretchable 5 - 5.2 mm; plain; snap-on type; yellow

www.wago.com/2009-115/000-002**Item no.: 2009-115/000-006**

WMB-Inline; for Smart Printer; 1500 pieces on roll; stretchable 5 - 5.2 mm; plain; snap-on type; white

www.wago.com/2009-115/000-006**Item no.: 2009-115/000-007**

WMB-Inline; for Smart Printer; 1500 pieces on roll; stretchable 5 - 5.2 mm; plain; snap-on type; gray

www.wago.com/2009-115/000-007**Item no.: 2009-115/000-012**

WMB-Inline; for Smart Printer; 1500 pieces on roll; stretchable 5 - 5.2 mm; plain; snap-on type; white

www.wago.com/2009-115/000-012**Item no.: 2009-115/000-017**

WMB-Inline; for Smart Printer; 1500 pieces on roll; stretchable 5 - 5.2 mm; plain; snap-on type; white

www.wago.com/2009-115/000-017

Subject to changes. Please also observe the further product documentation!

WAGO Kontakttechnik GmbH & Co. KG

Hansastr. 27













32423 Minden

Phone: +49571 887-0 | Fax: +49571 887-169

Email: info.de@wago.com | Web: www.wago.com

Do you have any questions about our products?

We are always happy to take your call at +49 (571) 887-44222.

| | | |
|------------------------------------------------------------------------------------|---------------------------------------------------------------------------------------------------------------------------------------------|----------------------------------------------------------------------------------|
|  | Item no.: 2009-115/000-023 WMB-Inline; for Smart Printer; 1500 pieces on roll; stretchable 5 - 5.2 mm; plain; snap-on type; green | www.wago.com/2009-115/000-023 |
| | Item no.: 2009-115/000-024 WMB-Inline; for Smart Printer; 1500 pieces on roll; stretchable 5 - 5.2 mm; plain; snap-on type; white | www.wago.com/2009-115/000-024 |
|  | Item no.: 209-128 Adaptor; gray | www.wago.com/209-128 |
|  | Item no.: 209-183 Marker card; white | www.wago.com/209-183 |
| | Item no.: 210-110 Fiber-tip pen | www.wago.com/210-110 |
|  | Item no.: 249-105 Group marker carrier; gray | www.wago.com/249-105 |
|  | Item no.: 793-501 WMB marking card; as card; not stretchable; plain; snap-on type; white | www.wago.com/793-501 |
|  | Item no.: 793-501/000-002 WMB marking card; as card; not stretchable; plain; snap-on type; yellow | www.wago.com/793-501/000-002 |
| | Item no.: 793-501/000-005 WMB marking card; as card; not stretchable; plain; snap-on type; red | www.wago.com/793-501/000-005 |
|  | Item no.: 793-501/000-006 WMB marking card; as card; not stretchable; plain; snap-on type; blue | www.wago.com/793-501/000-006 |
|  | Item no.: 793-501/000-007 WMB marking card; as card; not stretchable; plain; snap-on type; gray | www.wago.com/793-501/000-007 |
|  | Item no.: 793-501/000-012 WMB marking card; as card; not stretchable; plain; snap-on type; orange | www.wago.com/793-501/000-012 |
|  | Item no.: 793-501/000-017 WMB marking card; as card; not stretchable; plain; snap-on type; light green | www.wago.com/793-501/000-017 |
|  | Item no.: 793-501/000-023 WMB marking card; as card; not stretchable; plain; snap-on type; green | www.wago.com/793-501/000-023 |
|  | Item no.: 793-501/000-024 WMB marking card; as card; not stretchable; plain; snap-on type; violet | www.wago.com/793-501/000-024 |

Subject to changes. Please also observe the further product documentation!

**Item no.: 793-502**

WMB marking card; as card; MARKED; 1 ... 10 (10x); not stretchable; Horizontal marking; snap-on type; white www.wago.com/793-502

**Item no.: 793-502/000-002**

WMB marking card; as card; MARKED; 1 ... 10 (10x); not stretchable; Horizontal marking; snap-on type; yellow www.wago.com/793-502/000-002

**Item no.: 793-502/000-005**

WMB marking card; as card; MARKED; 1 ... 10 (10x); not stretchable; Horizontal marking; snap-on type; red www.wago.com/793-502/000-005

Item no.: 793-502/000-006

WMB marking card; as card; MARKED; 1 ... 10 (10x); not stretchable; Horizontal marking; snap-on type; blue www.wago.com/793-502/000-006

**Item no.: 793-502/000-007**

WMB marking card; as card; MARKED; 1 ... 10 (10x); not stretchable; Horizontal marking; snap-on type; gray www.wago.com/793-502/000-007

**Item no.: 793-502/000-012**

WMB marking card; as card; MARKED; 1 ... 10 (10x); not stretchable; Horizontal marking; snap-on type; orange www.wago.com/793-502/000-012

**Item no.: 793-502/000-017**

WMB marking card; as card; MARKED; 1 ... 10 (10x); not stretchable; Horizontal marking; snap-on type; light green www.wago.com/793-502/000-017

**Item no.: 793-502/000-023**

WMB marking card; as card; MARKED; 1 ... 10 (10x); not stretchable; Horizontal marking; snap-on type; green www.wago.com/793-502/000-023

**Item no.: 793-502/000-024**

WMB marking card; as card; MARKED; 1 ... 10 (10x); not stretchable; Horizontal marking; snap-on type; violet www.wago.com/793-502/000-024

**Item no.: 793-503**

WMB marking card; as card; MARKED; 11 ... 20 (10x); not stretchable; Horizontal marking; snap-on type; white www.wago.com/793-503

Item no.: 793-503/000-002

WMB marking card; as card; MARKED; 11 ... 20 (10x); not stretchable; Horizontal marking; snap-on type; yellow www.wago.com/793-503/000-002

**Item no.: 793-503/000-005**

WMB marking card; as card; MARKED; 11 ... 20 (10x); not stretchable; Horizontal marking; snap-on type; red www.wago.com/793-503/000-005

**Item no.: 793-503/000-006**

WMB marking card; as card; MARKED; 11 ... 20 (10x); not stretchable; Horizontal marking; snap-on type; blue www.wago.com/793-503/000-006

Item no.: 793-503/000-007

WMB marking card; as card; MARKED; 11 ... 20 (10x); not stretchable; Horizontal marking; snap-on type;

Subject to changes. Please also observe the further product documentation!

WAGO Kontakttechnik GmbH & Co. KG

Hansastr. 27

32423 Minden

Phone: +49571 887-0 | Fax: +49571 887-169

Email: info.de@wago.com | Web: www.wago.com

Do you have any questions about our products?

We are always happy to take your call at +49 (571) 887-44222.



gray

www.wago.com/793-503/000-007
Item no.: 793-503/000-012

WMB marking card; as card; MARKED; 11 ... 20 (10x); not stretchable; Horizontal marking; snap-on type; orange

www.wago.com/793-503/000-012
**Item no.: 793-503/000-017**

WMB marking card; as card; MARKED; 11 ... 20 (10x); not stretchable; Horizontal marking; snap-on type; light green

www.wago.com/793-503/000-017
**Item no.: 793-503/000-023**

WMB marking card; as card; MARKED; 11 ... 20 (10x); not stretchable; Horizontal marking; snap-on type; green

www.wago.com/793-503/000-023
Item no.: 793-503/000-024

WMB marking card; as card; MARKED; 11 ... 20 (10x); not stretchable; Horizontal marking; snap-on type; violet

www.wago.com/793-503/000-024
**Item no.: 793-504**

WMB marking card; as card; MARKED; 21 ... 30 (10x); not stretchable; Horizontal marking; snap-on type; white

www.wago.com/793-504
Item no.: 793-504/000-002

WMB marking card; as card; MARKED; 21 ... 30 (10x); not stretchable; Horizontal marking; snap-on type; yellow

www.wago.com/793-504/000-002
**Item no.: 793-504/000-005**

WMB marking card; as card; MARKED; 21 ... 30 (10x); not stretchable; Horizontal marking; snap-on type; red

www.wago.com/793-504/000-005
Item no.: 793-504/000-006

WMB marking card; as card; MARKED; 21 ... 30 (10x); not stretchable; Horizontal marking; snap-on type; blue

www.wago.com/793-504/000-006
**Item no.: 793-504/000-012**

WMB marking card; as card; MARKED; 21 ... 30 (10x); not stretchable; Horizontal marking; snap-on type; orange

www.wago.com/793-504/000-012
**Item no.: 793-504/000-017**

WMB marking card; as card; MARKED; 21 ... 30 (10x); not stretchable; Horizontal marking; snap-on type; light green

www.wago.com/793-504/000-017
**Item no.: 793-504/000-023**

WMB marking card; as card; MARKED; 21 ... 30 (10x); not stretchable; Horizontal marking; snap-on type; green

www.wago.com/793-504/000-023
Item no.: 793-505

WMB marking card; as card; MARKED; 31 ... 40 (10x); not stretchable; Horizontal marking; snap-on type; white

www.wago.com/793-505
Item no.: 793-505/000-005

WMB marking card; as card; MARKED; 31 ... 40 (10x); not stretchable; Horizontal marking; snap-on type;

Subject to changes. Please also observe the further product documentation!

WAGO Kontakttechnik GmbH & Co. KG

Hansastr. 27

32423 Minden

Phone: +49571 887-0 | Fax: +49571 887-169

Email: info.de@wago.com | Web: www.wago.com

Do you have any questions about our products?

We are always happy to take your call at +49 (571) 887-44222.



red

www.wago.com/793-505/000-005
**Item no.: 793-505/000-006**

WMB marking card; as card; MARKED; 31 ... 40 (10x); not stretchable; Horizontal marking; snap-on type; blue

www.wago.com/793-505/000-006
**Item no.: 793-505/000-007**

WMB marking card; as card; MARKED; 31 ... 40 (10x); not stretchable; Horizontal marking; snap-on type; gray

www.wago.com/793-505/000-007
**Item no.: 793-505/000-012**

WMB marking card; as card; MARKED; 31 ... 40 (10x); not stretchable; Horizontal marking; snap-on type; orange

www.wago.com/793-505/000-012
**Item no.: 793-506**

WMB marking card; as card; MARKED; 41 ... 50 (10x); not stretchable; Horizontal marking; snap-on type; white

www.wago.com/793-506
**Item no.: 793-506/000-005**

WMB marking card; as card; MARKED; 41 ... 50 (10x); not stretchable; Horizontal marking; snap-on type; red

www.wago.com/793-506/000-005
**Item no.: 793-506/000-006**

WMB marking card; as card; MARKED; 41 ... 50 (10x); not stretchable; Horizontal marking; snap-on type; blue

www.wago.com/793-506/000-006
**Item no.: 793-506/000-012**

WMB marking card; as card; MARKED; 41 ... 50 (10x); not stretchable; Horizontal marking; snap-on type; orange

www.wago.com/793-506/000-012
**Item no.: 793-506/000-017**

WMB marking card; as card; MARKED; 41 ... 50 (10x); not stretchable; Horizontal marking; snap-on type; light green

www.wago.com/793-506/000-017
**Item no.: 793-5501**

WMB marking card; as card; for terminal block width 5 - 17.5 mm; stretchable 5 - 5.2 mm; plain; snap-on type; white

www.wago.com/793-5501
**Item no.: 793-5501/000-002**

WMB marking card; as card; for terminal block width 5 - 17.5 mm; stretchable 5 - 5.2 mm; plain; snap-on type; yellow

www.wago.com/793-5501/000-002
Item no.: 793-5501/000-005

WMB marking card; as card; for terminal block width 5 - 17.5 mm; stretchable 5 - 5.2 mm; plain; snap-on type; red

www.wago.com/793-5501/000-005
Item no.: 793-5501/000-006

WMB marking card; as card; for terminal block width 5 - 17.5 mm; stretchable 5 - 5.2 mm; plain; snap-on type; blue

www.wago.com/793-5501/000-006
Item no.: 793-5501/000-007

WMB marking card; as card; for terminal block width 5 - 17.5 mm; stretchable 5 - 5.2 mm; plain; snap-on

Subject to changes. Please also observe the further product documentation!

WAGO Kontakttechnik GmbH & Co. KG

Hansastr. 27

32423 Minden

Phone: +49571 887-0 | Fax: +49571 887-169

Email: info.de@wago.com | Web: www.wago.com

Do you have any questions about our products?

We are always happy to take your call at +49 (571) 887-44222.



type; gray

www.wago.com/793-5501/000-007
**Item no.: 793-5501/000-012**

WMB marking card; as card; for terminal block width 5 - 17.5 mm; stretchable 5 - 5.2 mm; plain; snap-on type; orange

www.wago.com/793-5501/000-012
**Item no.: 793-5501/000-014**

WMB marking card; as card; for terminal block width 5 - 17.5 mm; stretchable 5 - 5.2 mm; plain; snap-on type; brown

www.wago.com/793-5501/000-014
**Item no.: 793-5501/000-017**

WMB marking card; as card; for terminal block width 5 - 17.5 mm; stretchable 5 - 5.2 mm; plain; snap-on type; green

www.wago.com/793-5501/000-017
**Item no.: 793-5501/000-023**

WMB marking card; as card; for terminal block width 5 - 17.5 mm; stretchable 5 - 5.2 mm; plain; snap-on type; light green

www.wago.com/793-5501/000-023
**Item no.: 793-5501/000-024**

WMB marking card; as card; for terminal block width 5 - 17.5 mm; stretchable 5 - 5.2 mm; plain; snap-on type; violet

www.wago.com/793-5501/000-024
**Item no.: 793-566**

WMB marking card; as card; MARKED; 1 ... 50 (2x); not stretchable; Horizontal marking; snap-on type; white

www.wago.com/793-566
**Item no.: 793-566/000-002**

WMB marking card; as card; MARKED; 1 ... 50 (2x); not stretchable; Horizontal marking; snap-on type; yellow

www.wago.com/793-566/000-002
**Item no.: 793-566/000-005**

WMB marking card; as card; MARKED; 1 ... 50 (2x); not stretchable; Horizontal marking; snap-on type; red

www.wago.com/793-566/000-005
**Item no.: 793-566/000-006**

WMB marking card; as card; MARKED; 1 ... 50 (2x); not stretchable; Horizontal marking; snap-on type; blue

www.wago.com/793-566/000-006
**Item no.: 793-566/000-007**

WMB marking card; as card; MARKED; 1 ... 50 (2x); not stretchable; Horizontal marking; snap-on type; gray

www.wago.com/793-566/000-007
**Item no.: 793-566/000-012**

WMB marking card; as card; MARKED; 1 ... 50 (2x); not stretchable; Horizontal marking; snap-on type; orange

www.wago.com/793-566/000-012
**Item no.: 793-566/000-017**

WMB marking card; as card; MARKED; 1 ... 50 (2x); not stretchable; Horizontal marking; snap-on type; light green

www.wago.com/793-566/000-017
Item no.: 793-566/000-023

Subject to changes. Please also observe the further product documentation!

WAGO Kontakttechnik GmbH & Co. KG

Hansastr. 27

32423 Minden

Phone: +49571 887-0 | Fax: +49571 887-169

Email: info.de@wago.com | Web: www.wago.com

Do you have any questions about our products?

We are always happy to take your call at +49 (571) 887-44222.



WMB marking card; as card; MARKED; 1 ... 50 (2x); not stretchable; Horizontal marking; snap-on type; green

www.wago.com/793-566/000-023



Item no.: 793-566/000-024

WMB marking card; as card; MARKED; 1 ... 50 (2x); not stretchable; Horizontal marking; snap-on type; violet

www.wago.com/793-566/000-024

Downloads

Documentation

Instruction Leaflet

| | | | |
|-----------------------------------------------------------------------------------------------------|--|---------------|----------|
| Relaisbaustein mit steckbarem Kleinschaltrelais 1 Wechsler (1u) Eingangsnennspannung AC/DC 115 V | | pdf 2.4 MB | Download |
|-----------------------------------------------------------------------------------------------------|--|---------------|----------|

| | | | |
|-------------------------------------------------------|-------------------------|---------------|----------|
| Elektromechanical and Solid-State Relays/Optocouplers | V 1.4.0 Oct 15, 2019 | pdf 2.4 MB | Download |
|-------------------------------------------------------|-------------------------|---------------|----------|

Additional Information

| | | | |
|----------------------------------------------------------|---------|-----------------|----------|
| Disposal; Electrical and electronic equipment, Packaging | V 1.0.0 | pdf 265.8 kB | Download |
|----------------------------------------------------------|---------|-----------------|----------|

| | | | |
|---------------------------|---------------------|-----------------|----------|
| Step Datei Serie 857-03xx | 1.0 Jun 20, 2011 | ifc 299.3 kB | Download |
|---------------------------|---------------------|-----------------|----------|

CAD/CAE-Data

CAD data

| | | | |
|----------------------|--|-----|----------|
| 2D/3D Models 857-357 | | URL | Download |
|----------------------|--|-----|----------|

CAE data

| | | | |
|---------------------------|--|-----|----------|
| EPLAN Data Portal 857-357 | | URL | Download |
|---------------------------|--|-----|----------|

| | | | |
|------------------------|--|-----|----------|
| WSCAD Universe 857-357 | | URL | Download |
|------------------------|--|-----|----------|

Installation Notes

Inserting a conductor

Subject to changes. Please also observe the further product documentation!

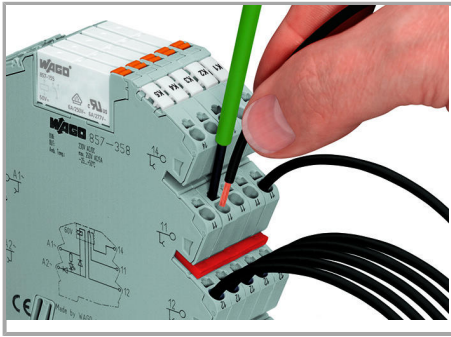

Connection of conductor

Jumpered

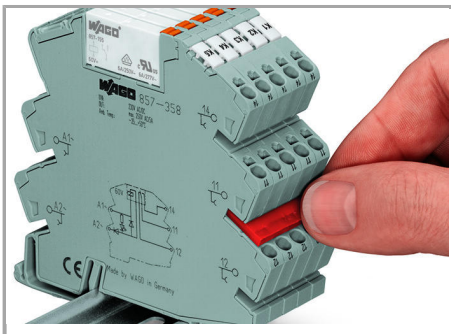

Easy commoning using adjacent jumpers

Marking

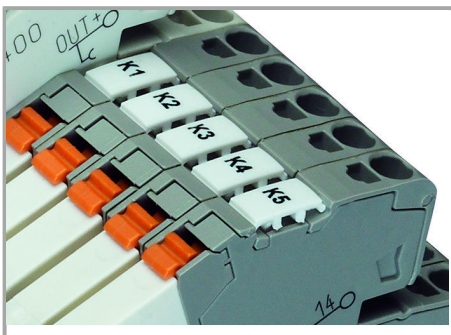

Marking using WMB Multi markers

Installation

Subject to changes. Please also observe the further product documentation!

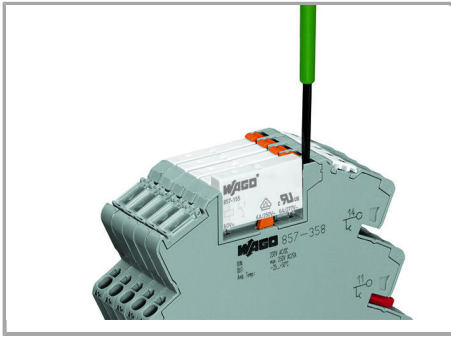

Operation of the relay ejector

Subject to changes. Please also observe the further product documentation!