

Data sheet | Item number: 857-305

Relay module; Nominal input voltage: 48 VDC; 1 changeover contact;
Limiting continuous current: 6 A; Yellow status indicator; Module width: 6 mm

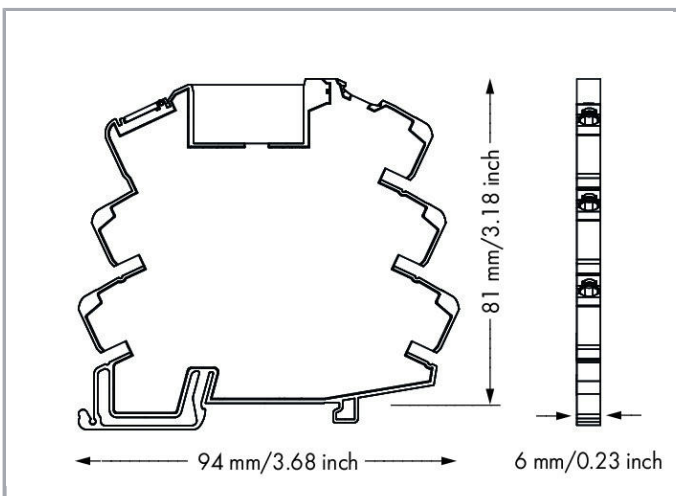

www.wago.com/857-305

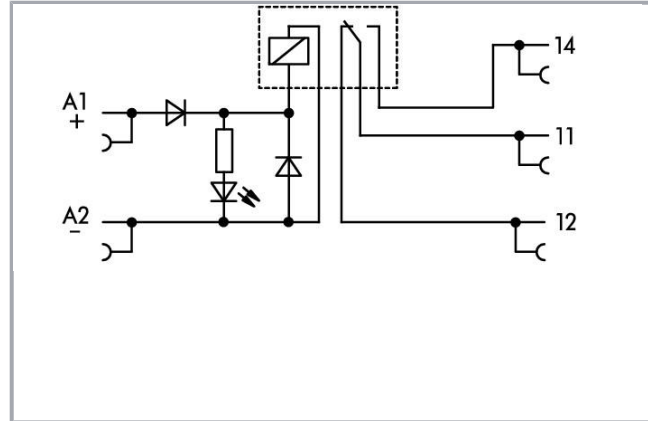
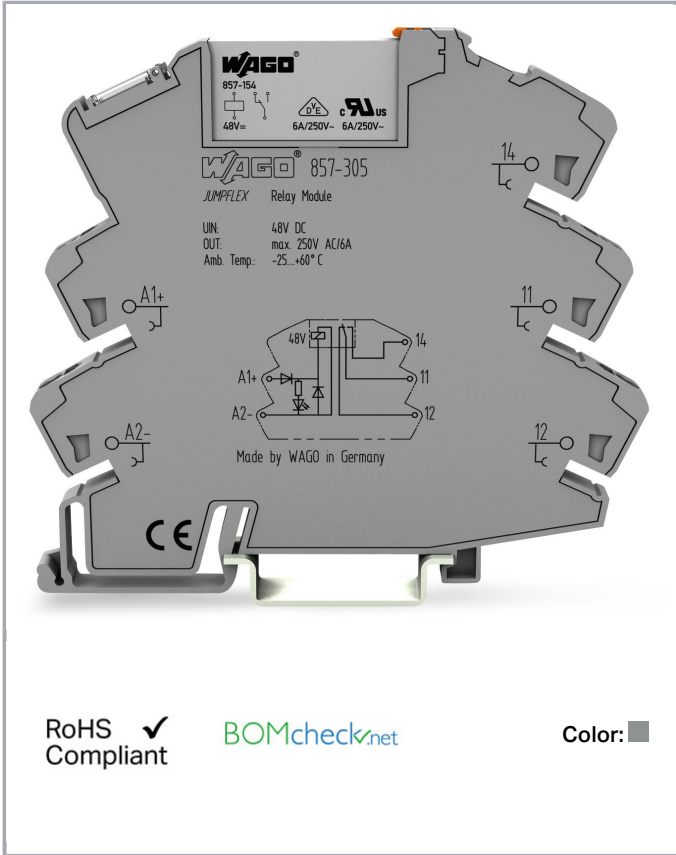

Subject to changes. Please also observe the further product documentation!

WAGO Kontakttechnik GmbH & Co. KG
Hansastr. 27
32423 Minden
Phone: +49571 887-0 | Fax: +49571 887-169
Email: info.de@wago.com | Web: www.wago.com

Do you have any questions about our products?
We are always happy to take your call at +49 (571) 887-44222.

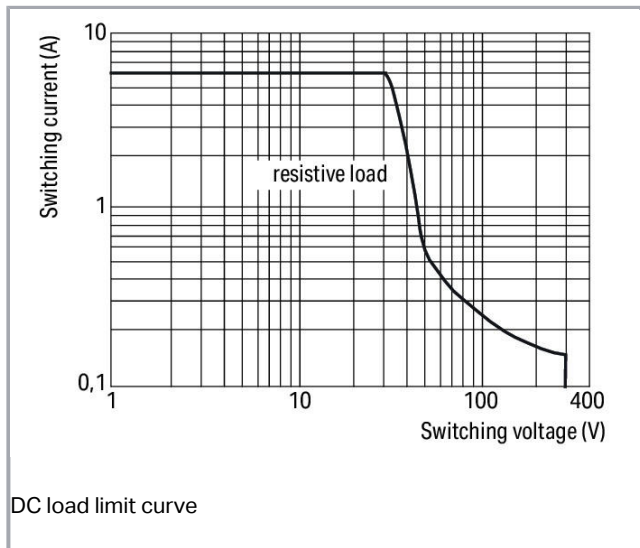

Item description

Note:

Inductive loads have to be attenuated by an appropriate protective circuit in order to protect relay coils and contacts.

Data

Technical Data

Control circuit

Nominal input voltage U_N	DC 48 V
Input voltage range	-15 ... +20 %
Nominal input current at U_N	6.5 mA

Load circuit:

Number of changeover/switchover contacts	1
Contact material (relay)	AgSnO ₂
Limiting continuous current	6 A
Max. make current (resistive)	(AC) 20 A / 0.02 s
Max. switching voltage	AC 250 V
Max. switching power (resistive)	AC 1500 VA; DC see load limit curve
Switching capacity	AC-15: 3 A / AC 250 V; DC-13: 2 A / DC 24 V

Subject to changes. Please also observe the further product documentation!



Recommended minimum load	10 V / 10 mA; 24 V / 1 mA
Pull-in time (typ.)	8 ms
Drop-out time (typ.)	8 ms
Bounce time (typ.)	3.5 ms
Electrical life (N.O.; resistive load; 23 °C)	50 x 10 ³ switching operations
Mechanical life	5 x 10 ⁶ switching operations
Max. switching load with load/without load	6 min ⁻¹ / 180 min ⁻¹

Signaling

Status indication	LED yellow
-------------------	------------

Safety and protection:

Rated voltage	250 V
Rated impulse voltage	4 kV
Pollution degree	2
Dielectric strength, control/load circuit (AC, 1 min)	4 kVrms
Dielectric strength open contact (AC, 1 min)	1 kVrms
Protection class	IP20

Connection data

Connection technology	Push-in CAGE CLAMP®
Solid conductor	0.34 ... 2.5 mm ² / 22 ... 14 AWG
Fine-stranded conductor	0.34 ... 2.5 mm ² / 22 ... 14 AWG
Strip length	9 ... 10 mm / 0.35 ... 0.39 inch

Geometrical Data

Width	6 mm / 0.236 inch
Height from upper-edge of DIN-35 rail	81 mm / 3.189 inch
Depth	94 mm / 3.701 inch

Mechanical data

Type of mounting	DIN-35 rail
------------------	-------------

Material Data

Color	gray
-------	------

Subject to changes. Please also observe the further product documentation!

Fire load	0.011 MJ
Weight	30.6 g

Environmental Requirements

Surrounding air (operating) temperature at U_N	-40 ... 60 °C
Surrounding air (storage) temperature	-40 ... 70 °C
Processing temperature	-25 ... +50 °C

Standards and specifications

Standards/specifications	EN 61010-2-201; EN 61810-1; EN 61373; UL 508
--------------------------	--

Elementary relay

WAGO elementary relay	857-154
-----------------------	---------

Commercial data

Product Group	6 (Interface Electronics)
Packaging type	BOX
Country of origin	DE
GTIN	4045454482442
Customs Tariff No.	85364900990

Approvals / Certificates

Ex-Approvals

Logo	Approval	Additional Approval Text	Certificate name
	UL UL International Germany GmbH (HAZARDOUS LOCATIONS)	ANSI/ISA 12.12.01	E198726 Sec.4

UL-Approvals

Logo	Approval	Additional Approval Text	Certificate name
	UL UL International Netherlands B.V. (ORDINARY LOCATIONS)	UL 508	E175199 Sec.4

Subject to changes. Please also observe the further product documentation!



Counterpart

Compatible products

General accessories

	Item no.: 209-184 Protection cover; transparent	www.wago.com/209-184
	Item no.: 857-154 Basic relay; Nominal input voltage: 48 VDC; 1 changeover contact; Limiting continuous current: 6 A; Module width: 5 mm; Module height: 15 mm	www.wago.com/857-154



ferrule

	Item no.: 216-241 Ferrule; Sleeve for 0.5 mm ² / 20 AWG; insulated; electro-tin plated; electrolytic copper; gastight crimped; acc. to DIN 46228, Part 4/09.90; white	www.wago.com/216-241
	Item no.: 216-242 Ferrule; Sleeve for 0.75 mm ² / 18 AWG; insulated; electro-tin plated; electrolytic copper; gastight crimped; acc. to DIN 46228, Part 4/09.90; gray	www.wago.com/216-242
	Item no.: 216-243 Ferrule; Sleeve for 1 mm ² / AWG 18; insulated; electro-tin plated; electrolytic copper; gastight crimped; acc. to DIN 46228, Part 4/09.90; red	www.wago.com/216-243
	Item no.: 216-244 Ferrule; Sleeve for 1.5 mm ² / AWG 16; insulated; electro-tin plated; electrolytic copper; gastight crimped; acc. to DIN 46228, Part 4/09.90; black	www.wago.com/216-244









tools

	Item no.: 210-720 Operating tool; Blade: 3.5 x 0.5 mm; with a partially insulated shaft	www.wago.com/210-720
--	---	--

Marking accessories

	Item no.: 2009-110 Marking strips; on reel; not stretchable; plain; snap-on type; white	www.wago.com/2009-110
	Item no.: 2009-115 WMB-Inline; for Smart Printer; 1500 pieces on roll; stretchable 5 - 5.2 mm; plain; snap-on type; white	www.wago.com/2009-115
	Item no.: 2009-115/000-002 WMB-Inline; for Smart Printer; 1500 pieces on roll; stretchable 5 - 5.2 mm; plain; snap-on type; yellow	www.wago.com/2009-115/000-002
	Item no.: 2009-115/000-006 WMB-Inline; for Smart Printer; 1500 pieces on roll; stretchable 5 - 5.2 mm; plain; snap-on type; white	www.wago.com/2009-115/000-006

Subject to changes. Please also observe the further product documentation!

	<p>Item no.: 2009-115/000-007 WMB-Inline; for Smart Printer; 1500 pieces on roll; stretchable 5 - 5.2 mm; plain; snap-on type; gray</p>	<p>www.wago.com/2009-115/000-007</p>
	<p>Item no.: 2009-115/000-012 WMB-Inline; for Smart Printer; 1500 pieces on roll; stretchable 5 - 5.2 mm; plain; snap-on type; white</p>	<p>www.wago.com/2009-115/000-012</p>
	<p>Item no.: 2009-115/000-017 WMB-Inline; for Smart Printer; 1500 pieces on roll; stretchable 5 - 5.2 mm; plain; snap-on type; white</p>	<p>www.wago.com/2009-115/000-017</p>
	<p>Item no.: 2009-115/000-023 WMB-Inline; for Smart Printer; 1500 pieces on roll; stretchable 5 - 5.2 mm; plain; snap-on type; green</p>	<p>www.wago.com/2009-115/000-023</p>
	<p>Item no.: 2009-115/000-024 WMB-Inline; for Smart Printer; 1500 pieces on roll; stretchable 5 - 5.2 mm; plain; snap-on type; white</p>	<p>www.wago.com/2009-115/000-024</p>
	<p>Item no.: 209-128 Adaptor; gray</p>	<p>www.wago.com/209-128</p>
	<p>Item no.: 209-183 Marker card; white</p>	<p>www.wago.com/209-183</p>
	<p>Item no.: 210-110 Fiber-tip pen</p>	<p>www.wago.com/210-110</p>
	<p>Item no.: 249-105 Group marker carrier; gray</p>	<p>www.wago.com/249-105</p>
	<p>Item no.: 793-501 WMB marking card; as card; not stretchable; plain; snap-on type; white</p>	<p>www.wago.com/793-501</p>
	<p>Item no.: 793-501/000-002 WMB marking card; as card; not stretchable; plain; snap-on type; yellow</p>	<p>www.wago.com/793-501/000-002</p>
	<p>Item no.: 793-501/000-005 WMB marking card; as card; not stretchable; plain; snap-on type; red</p>	<p>www.wago.com/793-501/000-005</p>
	<p>Item no.: 793-501/000-006 WMB marking card; as card; not stretchable; plain; snap-on type; blue</p>	<p>www.wago.com/793-501/000-006</p>
	<p>Item no.: 793-501/000-007 WMB marking card; as card; not stretchable; plain; snap-on type; gray</p>	<p>www.wago.com/793-501/000-007</p>
	<p>Item no.: 793-501/000-012 WMB marking card; as card; not stretchable; plain; snap-on type; orange</p>	<p>www.wago.com/793-501/000-012</p>

Subject to changes. Please also observe the further product documentation!



Item no.: 793-501/000-017

WMB marking card; as card; not stretchable; plain; snap-on type; light green

www.wago.com/793-501/000-017

Item no.: 793-501/000-023

WMB marking card; as card; not stretchable; plain; snap-on type; green

www.wago.com/793-501/000-023

Item no.: 793-501/000-024

WMB marking card; as card; not stretchable; plain; snap-on type; violet

www.wago.com/793-501/000-024



Item no.: 793-502

WMB marking card; as card; MARKED; 1 ... 10 (10x); not stretchable; Horizontal marking; snap-on type; white

www.wago.com/793-502



Item no.: 793-502/000-002

WMB marking card; as card; MARKED; 1 ... 10 (10x); not stretchable; Horizontal marking; snap-on type; yellow

www.wago.com/793-502/000-002

Item no.: 793-502/000-005

WMB marking card; as card; MARKED; 1 ... 10 (10x); not stretchable; Horizontal marking; snap-on type; red

www.wago.com/793-502/000-005

Item no.: 793-502/000-006

WMB marking card; as card; MARKED; 1 ... 10 (10x); not stretchable; Horizontal marking; snap-on type; blue

www.wago.com/793-502/000-006

Item no.: 793-502/000-007

WMB marking card; as card; MARKED; 1 ... 10 (10x); not stretchable; Horizontal marking; snap-on type; gray

www.wago.com/793-502/000-007



Item no.: 793-502/000-012

WMB marking card; as card; MARKED; 1 ... 10 (10x); not stretchable; Horizontal marking; snap-on type; orange

www.wago.com/793-502/000-012



Item no.: 793-502/000-017

WMB marking card; as card; MARKED; 1 ... 10 (10x); not stretchable; Horizontal marking; snap-on type; light green

www.wago.com/793-502/000-017



Item no.: 793-502/000-023

WMB marking card; as card; MARKED; 1 ... 10 (10x); not stretchable; Horizontal marking; snap-on type; green

www.wago.com/793-502/000-023

Item no.: 793-502/000-024

WMB marking card; as card; MARKED; 1 ... 10 (10x); not stretchable; Horizontal marking; snap-on type; violet

www.wago.com/793-502/000-024

Item no.: 793-503

WMB marking card; as card; MARKED; 11 ... 20 (10x); not stretchable; Horizontal marking; snap-on type; white

www.wago.com/793-503

Item no.: 793-503/000-002

WMB marking card; as card; MARKED; 11 ... 20 (10x); not stretchable; Horizontal marking; snap-on type;

Subject to changes. Please also observe the further product documentation!

yellow

www.wago.com/793-503/000-002
**Item no.: 793-503/000-005**

WMB marking card; as card; MARKED; 11 ... 20 (10x); not stretchable; Horizontal marking; snap-on type; red

www.wago.com/793-503/000-005
Item no.: 793-503/000-006

WMB marking card; as card; MARKED; 11 ... 20 (10x); not stretchable; Horizontal marking; snap-on type; blue

www.wago.com/793-503/000-006
Item no.: 793-503/000-007

WMB marking card; as card; MARKED; 11 ... 20 (10x); not stretchable; Horizontal marking; snap-on type; gray

www.wago.com/793-503/000-007
Item no.: 793-503/000-012

WMB marking card; as card; MARKED; 11 ... 20 (10x); not stretchable; Horizontal marking; snap-on type; orange

www.wago.com/793-503/000-012
Item no.: 793-503/000-017

WMB marking card; as card; MARKED; 11 ... 20 (10x); not stretchable; Horizontal marking; snap-on type; light green

www.wago.com/793-503/000-017
Item no.: 793-503/000-023

WMB marking card; as card; MARKED; 11 ... 20 (10x); not stretchable; Horizontal marking; snap-on type; green

www.wago.com/793-503/000-023
Item no.: 793-503/000-024

WMB marking card; as card; MARKED; 11 ... 20 (10x); not stretchable; Horizontal marking; snap-on type; violet

www.wago.com/793-503/000-024
**Item no.: 793-504**

WMB marking card; as card; MARKED; 21 ... 30 (10x); not stretchable; Horizontal marking; snap-on type; white

www.wago.com/793-504
**Item no.: 793-504/000-002**

WMB marking card; as card; MARKED; 21 ... 30 (10x); not stretchable; Horizontal marking; snap-on type; yellow

www.wago.com/793-504/000-002
**Item no.: 793-504/000-005**

WMB marking card; as card; MARKED; 21 ... 30 (10x); not stretchable; Horizontal marking; snap-on type; red

www.wago.com/793-504/000-005
**Item no.: 793-504/000-006**

WMB marking card; as card; MARKED; 21 ... 30 (10x); not stretchable; Horizontal marking; snap-on type; blue

www.wago.com/793-504/000-006
Item no.: 793-504/000-012

WMB marking card; as card; MARKED; 21 ... 30 (10x); not stretchable; Horizontal marking; snap-on type; orange

www.wago.com/793-504/000-012
Item no.: 793-504/000-017

Subject to changes. Please also observe the further product documentation!

WAGO Kontakttechnik GmbH & Co. KG

Hansastr. 27

32423 Minden

Phone: +49571 887-0 | Fax: +49571 887-169

Email: info.de@wago.com | Web: www.wago.com

Do you have any questions about our products?

We are always happy to take your call at +49 (571) 887-44222.



WMB marking card; as card; MARKED; 21 ... 30 (10x); not stretchable; Horizontal marking; snap-on type; light green

www.wago.com/793-504/000-017

Item no.: 793-504/000-023

WMB marking card; as card; MARKED; 21 ... 30 (10x); not stretchable; Horizontal marking; snap-on type; green

www.wago.com/793-504/000-023



Item no.: 793-505

WMB marking card; as card; MARKED; 31 ... 40 (10x); not stretchable; Horizontal marking; snap-on type; white

www.wago.com/793-505



Item no.: 793-505/000-005

WMB marking card; as card; MARKED; 31 ... 40 (10x); not stretchable; Horizontal marking; snap-on type; red

www.wago.com/793-505/000-005



Item no.: 793-505/000-006

WMB marking card; as card; MARKED; 31 ... 40 (10x); not stretchable; Horizontal marking; snap-on type; blue

www.wago.com/793-505/000-006



Item no.: 793-505/000-007

WMB marking card; as card; MARKED; 31 ... 40 (10x); not stretchable; Horizontal marking; snap-on type; gray

www.wago.com/793-505/000-007



Item no.: 793-505/000-012

WMB marking card; as card; MARKED; 31 ... 40 (10x); not stretchable; Horizontal marking; snap-on type; orange

www.wago.com/793-505/000-012



Item no.: 793-506

WMB marking card; as card; MARKED; 41 ... 50 (10x); not stretchable; Horizontal marking; snap-on type; white

www.wago.com/793-506



Item no.: 793-506/000-005

WMB marking card; as card; MARKED; 41 ... 50 (10x); not stretchable; Horizontal marking; snap-on type; red

www.wago.com/793-506/000-005



Item no.: 793-506/000-006

WMB marking card; as card; MARKED; 41 ... 50 (10x); not stretchable; Horizontal marking; snap-on type; blue

www.wago.com/793-506/000-006



Item no.: 793-506/000-012

WMB marking card; as card; MARKED; 41 ... 50 (10x); not stretchable; Horizontal marking; snap-on type; orange

www.wago.com/793-506/000-012



Item no.: 793-506/000-017

WMB marking card; as card; MARKED; 41 ... 50 (10x); not stretchable; Horizontal marking; snap-on type; light green

www.wago.com/793-506/000-017



Item no.: 793-5501

WMB marking card; as card; for terminal block width 5 - 17.5 mm; stretchable 5 - 5.2 mm; plain; snap-on type; white

www.wago.com/793-5501















Item no.: 793-5501/000-002

WMB marking card; as card; for terminal block width 5 - 17.5 mm; stretchable 5 - 5.2 mm; plain; snap-on type; yellow

www.wago.com/793-5501/000-002

Subject to changes. Please also observe the further product documentation!

	Item no.: 793-5501/000-005 WMB marking card; as card; for terminal block width 5 - 17.5 mm; stretchable 5 - 5.2 mm; plain; snap-on type; red	www.wago.com/793-5501/000-005
	Item no.: 793-5501/000-006 WMB marking card; as card; for terminal block width 5 - 17.5 mm; stretchable 5 - 5.2 mm; plain; snap-on type; blue	www.wago.com/793-5501/000-006
	Item no.: 793-5501/000-007 WMB marking card; as card; for terminal block width 5 - 17.5 mm; stretchable 5 - 5.2 mm; plain; snap-on type; gray	www.wago.com/793-5501/000-007
	Item no.: 793-5501/000-012 WMB marking card; as card; for terminal block width 5 - 17.5 mm; stretchable 5 - 5.2 mm; plain; snap-on type; orange	www.wago.com/793-5501/000-012
	Item no.: 793-5501/000-014 WMB marking card; as card; for terminal block width 5 - 17.5 mm; stretchable 5 - 5.2 mm; plain; snap-on type; brown	www.wago.com/793-5501/000-014
	Item no.: 793-5501/000-017 WMB marking card; as card; for terminal block width 5 - 17.5 mm; stretchable 5 - 5.2 mm; plain; snap-on type; green	www.wago.com/793-5501/000-017
	Item no.: 793-5501/000-023 WMB marking card; as card; for terminal block width 5 - 17.5 mm; stretchable 5 - 5.2 mm; plain; snap-on type; light green	www.wago.com/793-5501/000-023
	Item no.: 793-5501/000-024 WMB marking card; as card; for terminal block width 5 - 17.5 mm; stretchable 5 - 5.2 mm; plain; snap-on type; violet	www.wago.com/793-5501/000-024
	Item no.: 793-566 WMB marking card; as card; MARKED; 1 ... 50 (2x); not stretchable; Horizontal marking; snap-on type; white	www.wago.com/793-566
	Item no.: 793-566/000-002 WMB marking card; as card; MARKED; 1 ... 50 (2x); not stretchable; Horizontal marking; snap-on type; yellow	www.wago.com/793-566/000-002
	Item no.: 793-566/000-005 WMB marking card; as card; MARKED; 1 ... 50 (2x); not stretchable; Horizontal marking; snap-on type; red	www.wago.com/793-566/000-005
	Item no.: 793-566/000-006 WMB marking card; as card; MARKED; 1 ... 50 (2x); not stretchable; Horizontal marking; snap-on type; blue	www.wago.com/793-566/000-006
	Item no.: 793-566/000-007 WMB marking card; as card; MARKED; 1 ... 50 (2x); not stretchable; Horizontal marking; snap-on type; gray	www.wago.com/793-566/000-007

Subject to changes. Please also observe the further product documentation!

**Item no.: 793-566/000-012**

WMB marking card; as card; MARKED; 1 ... 50 (2x); not stretchable; Horizontal marking; snap-on type; orange

www.wago.com/793-566/000-012**Item no.: 793-566/000-017**

WMB marking card; as card; MARKED; 1 ... 50 (2x); not stretchable; Horizontal marking; snap-on type; light green

www.wago.com/793-566/000-017**Item no.: 793-566/000-023**

WMB marking card; as card; MARKED; 1 ... 50 (2x); not stretchable; Horizontal marking; snap-on type; green

www.wago.com/793-566/000-023**Item no.: 793-566/000-024**

WMB marking card; as card; MARKED; 1 ... 50 (2x); not stretchable; Horizontal marking; snap-on type; violet

www.wago.com/793-566/000-024**Jumper****Item no.: 281-482**

Comb-style jumper bar; insulated; 2-way; IN = IN terminal block; gray

www.wago.com/281-482**Item no.: 859-402**

Push-in type jumper bar; 2-way; Nominal current 18 A; insulated; light gray

www.wago.com/859-402**Item no.: 859-402/000-005**

Push-in type jumper bar; 2-way; Nominal current 18 A; insulated; red

www.wago.com/859-402/000-005**Item no.: 859-402/000-006**

Push-in type jumper bar; 2-way; Nominal current 18 A; insulated; blue

www.wago.com/859-402/000-006**Item no.: 859-402/000-029**

Push-in type jumper bar; 2-way; Nominal current 18 A; insulated; yellow

www.wago.com/859-402/000-029**Item no.: 859-403**

Push-in type jumper bar; 3-way; Nominal current 18 A; insulated; light gray

www.wago.com/859-403**Item no.: 859-403/000-005**

Push-in type jumper bar; 3-way; Nominal current 18 A; insulated; red

www.wago.com/859-403/000-005**Item no.: 859-403/000-006**

Push-in type jumper bar; 3-way; Nominal current 18 A; insulated; blue

www.wago.com/859-403/000-006**Item no.: 859-403/000-029**

Push-in type jumper bar; 3-way; Nominal current 18 A; insulated; yellow

www.wago.com/859-403/000-029**Item no.: 859-404**

Push-in type jumper bar; 4-way; Nominal current 18 A; insulated; light gray

www.wago.com/859-404

Subject to changes. Please also observe the further product documentation!

WAGO Kontakttechnik GmbH & Co. KG

Hansastr. 27

32423 Minden

Phone: +49571 887-0 | Fax: +49571 887-169

Email: info.de@wago.com | Web: www.wago.com

Do you have any questions about our products?

We are always happy to take your call at +49 (571) 887-44222.

Item no.: 859-404/000-005

Push-in type jumper bar; 4-way; Nominal current 18 A; insulated; red

www.wago.com/859-404/000-005



Item no.: 859-404/000-006

Push-in type jumper bar; 4-way; Nominal current 18 A; insulated; blue

www.wago.com/859-404/000-006



Item no.: 859-404/000-029

Push-in type jumper bar; 4-way; Nominal current 18 A; insulated; yellow

www.wago.com/859-404/000-029



Item no.: 859-405

Push-in type jumper bar; 5-way; Nominal current 18 A; insulated; light gray

www.wago.com/859-405



Item no.: 859-405/000-005

Push-in type jumper bar; 5-way; Nominal current 18 A; insulated; red

www.wago.com/859-405/000-005



Item no.: 859-405/000-006

Push-in type jumper bar; 5-way; Nominal current 18 A; insulated; blue

www.wago.com/859-405/000-006



Item no.: 859-405/000-029

Push-in type jumper bar; 5-way; Nominal current 18 A; insulated; yellow

www.wago.com/859-405/000-029



Item no.: 859-406

Push-in type jumper bar; 6-way; Nominal current 18 A; insulated; light gray

www.wago.com/859-406

Item no.: 859-406/000-005

Push-in type jumper bar; 6-way; Nominal current 18 A; insulated; red

www.wago.com/859-406/000-005



Item no.: 859-406/000-006

Push-in type jumper bar; 6-way; Nominal current 18 A; insulated; blue

www.wago.com/859-406/000-006



Item no.: 859-406/000-029

Push-in type jumper bar; 6-way; Nominal current 18 A; insulated; yellow

www.wago.com/859-406/000-029



Item no.: 859-407

Push-in type jumper bar; 7-way; Nominal current 18 A; insulated; light gray

www.wago.com/859-407



Item no.: 859-407/000-005

Push-in type jumper bar; 7-way; Nominal current 18 A; insulated; red

www.wago.com/859-407/000-005



Item no.: 859-407/000-006

Push-in type jumper bar; 7-way; Nominal current 18 A; insulated; blue

www.wago.com/859-407/000-006

Subject to changes. Please also observe the further product documentation!

WAGO Kontakttechnik GmbH & Co. KG

Hansastr. 27

32423 Minden

Phone: +49571 887-0 | Fax: +49571 887-169

Email: info.de@wago.com | Web: www.wago.com

Do you have any questions about our products?

We are always happy to take your call at +49 (571) 887-44222.



Item no.: 859-407/000-029
Push-in type jumper bar; 7-way; Nominal current 18 A; insulated; yellow

www.wago.com/859-407/000-029



Item no.: 859-408
Push-in type jumper bar; 8-way; Nominal current 18 A; insulated; light gray

www.wago.com/859-408



Item no.: 859-408/000-005
Push-in type jumper bar; 8-way; Nominal current 18 A; insulated; red

www.wago.com/859-408/000-005



Item no.: 859-408/000-006
Push-in type jumper bar; 8-way; Nominal current 18 A; insulated; blue

www.wago.com/859-408/000-006



Item no.: 859-408/000-029
Push-in type jumper bar; 8-way; Nominal current 18 A; insulated; yellow

www.wago.com/859-408/000-029



Item no.: 859-409
Push-in type jumper bar; 9-way; Nominal current 18 A; insulated; light gray

www.wago.com/859-409

Item no.: 859-409/000-005
Push-in type jumper bar; 9-way; Nominal current 18 A; insulated; red

www.wago.com/859-409/000-005



Item no.: 859-409/000-006
Push-in type jumper bar; 9-way; Nominal current 18 A; insulated; blue

www.wago.com/859-409/000-006



Item no.: 859-409/000-029
Push-in type jumper bar; 9-way; Nominal current 18 A; insulated; yellow

www.wago.com/859-409/000-029



Item no.: 859-410
Push-in type jumper bar; 10-way; Nominal current 18 A; insulated; light gray

www.wago.com/859-410



Item no.: 859-410/000-005
Push-in type jumper bar; 10-way; Nominal current 18 A; insulated; red

www.wago.com/859-410/000-005

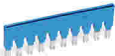

Item no.: 859-410/000-006
Push-in type jumper bar; 10-way; Nominal current 18 A; insulated; blue

www.wago.com/859-410/000-006



Item no.: 859-410/000-029
Push-in type jumper bar; 10-way; Nominal current 18 A; insulated; yellow

www.wago.com/859-410/000-029

Subject to changes. Please also observe the further product documentation!



Downloads

Documentation

Instruction Leaflet

Relaisbaustein mit steckbarem Kleinschaltrelais Eingangsnennspannung DC 48V		pdf 2.4 MB	Download
--	--	---------------	----------

Elektromechanical and Solid-State Relays/Optocouplers	V 1.4.0 Oct 15, 2019	pdf 2.4 MB	Download
---	-------------------------	---------------	----------

Additional Information

Disposal; Electrical and electronic equipment, Packaging	V 1.0.0	pdf 265.8 kB	Download
--	---------	-----------------	----------

Step Datei Serie 857-03xx	1.0 Jun 20, 2011	ifc 299.3 kB	Download
---------------------------	---------------------	-----------------	----------

CAD/CAE-Data

CAD data

2D/3D Models 857-305		URL	Download
----------------------	--	-----	----------

CAE data

EPLAN Data Portal 857-305		URL	Download
---------------------------	--	-----	----------

WSCAD Universe 857-305		URL	Download
------------------------	--	-----	----------

Installation Notes

Inserting a conductor

Subject to changes. Please also observe the further product documentation!

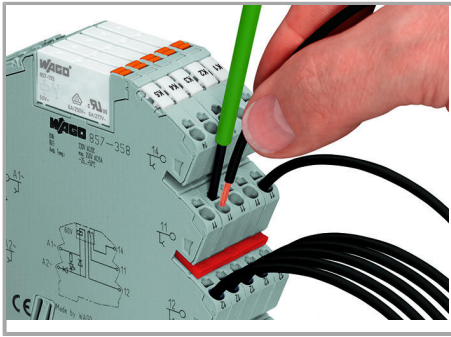

Connection of conductor

Jumpered

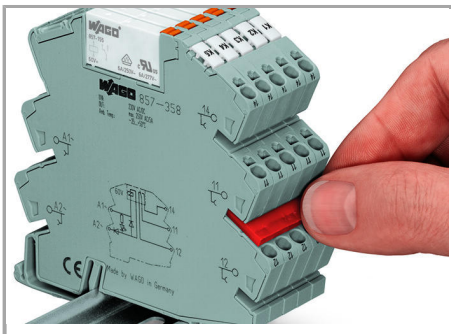

Easy commoning using adjacent jumpers

Marking

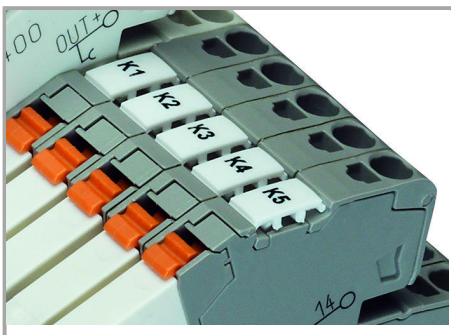

Marking using WMB Multi markers

Installation

Subject to changes. Please also observe the further product documentation!

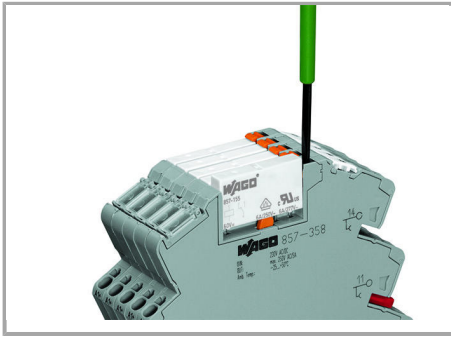

Operation of the relay ejector

Subject to changes. Please also observe the further product documentation!