

Data sheet | Item number: 792-800

Surge suppression module for signal technology; Nominal voltage: 24 VDC;
for 2 signal paths with common surge arrester; for unbalanced interfaces;
Two-stage; Width: 6 mm; 2,50 mm²

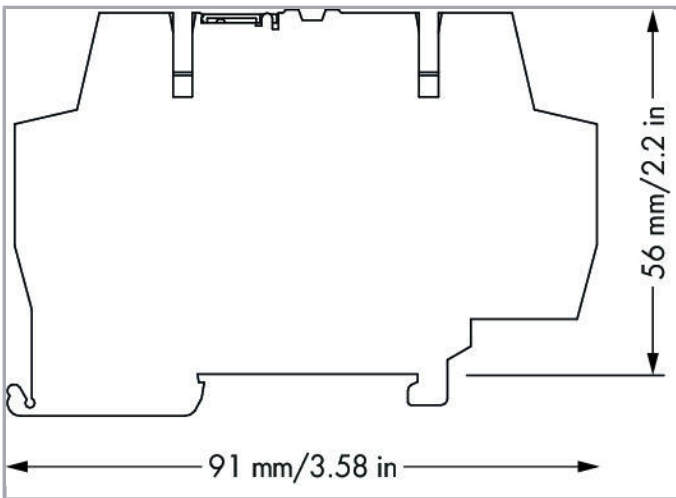

www.wago.com/792-800

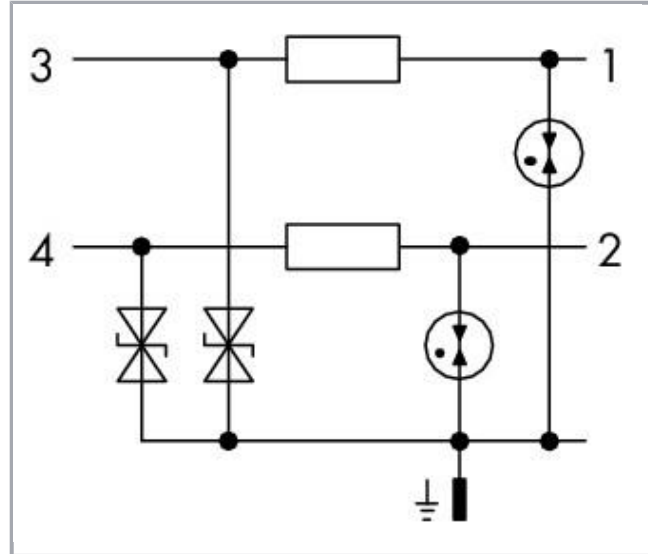
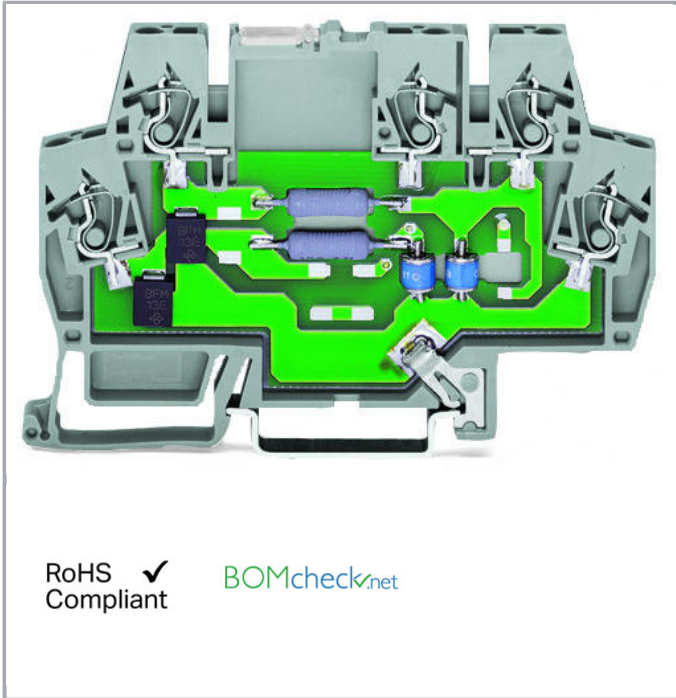

Item description

Short description:

Subject to changes. Please also observe the further product documentation!

WAGO Kontakttechnik GmbH & Co. KG
Hansastr. 27
32423 Minden
Phone: +49571 887-0 | Fax: +49571 887-169
Email: info.de@wago.com | Web: www.wago.com

Do you have any questions about our products?
We are always happy to take your call at +49 (571) 887-44222.



Provides surge protection for IT systems and devices in the voltage range up to 60 V (except custom solutions, e.g., telephone systems with ringing voltage).

Overvoltage protection is also possible for DIN-35 rail-mount terminal blocks. Multi-stage surge arresters in rail-mount terminal blocks (792-80x Series) of just 6 mm width ensure cost-effective protection for control and bus technology (e.g., LON[®] network, PROFIBUS network, binary signals).

Features:

- Protect your system against overvoltage
- Slim, space-saving design
- Control operational costs by preventing expensive, unplanned downtime
- High operational reliability and system uptime

Note:

The coordination characteristics of the surge arrester provide information about its discharge capacity and protection capability.

Data

Electrical data

Nominal operating voltage	DC 24 V
Maximum continuous operating voltage	AC 23 V / DC 33 V
Nominal current	0.5 A
Nominal discharge current (8/20 μ s) per line	5 kA
Nominal discharge current (8/20 μ s) in total	10 kA
Voltage protection level line/line (cat. C2 at I_N)	≤ 65 V
Voltage protection level line/PG (cat. C2 at I_N)	≤ 110 V
Voltage protection level line/line (cat. C3 at I_N)	≤ 90 V
Voltage protection level line/PG (cat. C3 at I_N)	≤ 45 V
Response time line/PG	≤ 1 ns
Limit frequency line/line	6 MHz
Limiting frequency Ader/PG	6 MHz
Impedance	1.8 Ω
Capacity line/line	≤ 5 nF
Capacity line/PG	≤ 1 nF

Safety and protection:

Protection class	IP00
------------------	------

Subject to changes. Please also observe the further product documentation!

WAGO Kontakttechnik GmbH & Co. KG

Hansastr. 27

32423 Minden

Phone: +49571 887-0 | Fax: +49571 887-169

Email: info.de@wago.com | Web: www.wago.com

Do you have any questions about our products?

We are always happy to take your call at +49 (571) 887-44222.



Degree of protection with end and intermediate plate	IP20
--	------

Connection data

Connections (number)	5
Connection technology	CAGE CLAMP®
Solid conductor	0,08 ... 2,5 mm ² / 28 ... 14 AWG
Fine-stranded conductor	0,08 ... 2,5 mm ² / 28 ... 14 AWG
Strip length	5 ... 6 mm / 0.2 ... 0.24 inch

Geometrical Data

Width	6 mm / 0.236 inch
Height from upper-edge of DIN-35 rail	56 mm / 2.205 inch
Depth	91 mm / 3.583 inch

Mechanical data

Type of mounting	DIN-35 rail
------------------	-------------

Material Data

Weight	38.8 g
--------	--------

Environmental Requirements

Surrounding air (operating) temperature	-40 ... 80 °C
Surrounding air (storage) temperature	-40 ... 80 °C

Standards and specifications

Standards/specifications	IEC 61643-21
--------------------------	--------------

Commercial data

Product Group	21 (Special Products Electronic)
Packaging type	BOX
Country of origin	DE
GTIN	4017332780735
Customs Tariff No.	85363010900

Counterpart

Subject to changes. Please also observe the further product documentation!

WAGO Kontakttechnik GmbH & Co. KG
 Hansastr. 27
 32423 Minden
 Phone: +49571 887-0 | Fax: +49571 887-169
 Email: info.de@wago.com | Web: www.wago.com





Do you have any questions about our products?
 We are always happy to take your call at +49 (571) 887-44222.

Compatible products

Marking accessories

	Item no.: 2009-145 Mini-WSB Inline; for Smart Printer; 1700 pieces on roll; stretchable 5 - 5.2 mm; plain; snap-on type; white	www.wago.com/2009-145
	Item no.: 2009-145/000-002 Mini-WSB Inline; for Smart Printer; 1700 pieces on roll; stretchable 5 - 5.2 mm; plain; snap-on type; white	www.wago.com/2009-145/000-002
	Item no.: 2009-145/000-005 Mini-WSB Inline; for Smart Printer; 1700 pieces on roll; stretchable 5 - 5.2 mm; plain; snap-on type; red	www.wago.com/2009-145/000-005
	Item no.: 2009-145/000-006 Mini-WSB Inline; for Smart Printer; 1700 pieces on roll; stretchable 5 - 5.2 mm; plain; snap-on type; blue	www.wago.com/2009-145/000-006
	Item no.: 2009-145/000-007 Mini-WSB Inline; for Smart Printer; 1700 pieces on roll; stretchable 5 - 5.2 mm; plain; snap-on type; white	www.wago.com/2009-145/000-007
	Item no.: 2009-145/000-012 Mini-WSB Inline; for Smart Printer; 1700 pieces on roll; stretchable 5 - 5.2 mm; plain; snap-on type; orange	www.wago.com/2009-145/000-012
	Item no.: 2009-145/000-023 Mini-WSB Inline; for Smart Printer; 1700 pieces on roll; stretchable 5 - 5.2 mm; plain; snap-on type; green	www.wago.com/2009-145/000-023
	Item no.: 2009-145/000-024 Mini-WSB Inline; for Smart Printer; 1700 pieces on roll; stretchable 5 - 5.2 mm; plain; snap-on type; violet	www.wago.com/2009-145/000-024
	Item no.: 210-110 Fiber-tip pen	www.wago.com/210-110
	Item no.: 248-450 Mini-WSB marking card; as card; MARKED; K1 - K10 (10x); not stretchable; Horizontal marking; snap-on type; white	www.wago.com/248-450
	Item no.: 248-451 Mini-WSB marking card; as card; MARKED; K11 - K20 (10x); not stretchable; Horizontal marking; snap-on type; white	www.wago.com/248-451
	Item no.: 248-452 Mini-WSB marking card; as card; MARKED; K (100x); not stretchable; Horizontal marking; snap-on type; white	www.wago.com/248-452

Subject to changes. Please also observe the further product documentation!

Item no.: 248-453	Mini-WSB marking card; as card; MARKED; U1, ... U10 (10x); not stretchable; Horizontal marking; snap-on type; white	www.wago.com/248-453
Item no.: 248-454	Mini-WSB marking card; as card; MARKED; U11 - U20 (10x); not stretchable; Horizontal marking; snap-on type; white	www.wago.com/248-454
Item no.: 248-455	Mini-WSB marking card; as card; MARKED; U 100 (10x); not stretchable; Horizontal marking; snap-on type; white	www.wago.com/248-455
Item no.: 248-501	Miniature WSB Quick marking system; plain; Marker width 5 mm; 10 strips with 10 markers per card	www.wago.com/248-501
Item no.: 248-501/000-002	Mini-WSB marking card; as card; not stretchable; plain; snap-on type; yellow	www.wago.com/248-501/000-002
Item no.: 248-501/000-005	Mini-WSB marking card; as card; not stretchable; plain; snap-on type; red	www.wago.com/248-501/000-005
	Item no.: 248-501/000-006	www.wago.com/248-501/000-006
Mini-WSB marking card; as card; not stretchable; plain; snap-on type; blue		
	Item no.: 248-501/000-007	www.wago.com/248-501/000-007
Mini-WSB marking card; as card; not stretchable; plain; snap-on type; gray		
	Item no.: 248-501/000-012	www.wago.com/248-501/000-012
Mini-WSB marking card; as card; not stretchable; plain; snap-on type; orange		
Item no.: 248-501/000-017	Mini-WSB marking card; as card; not stretchable; plain; snap-on type; light green	www.wago.com/248-501/000-017
Item no.: 248-501/000-023	Mini-WSB marking card; as card; not stretchable; plain; snap-on type; green	www.wago.com/248-501/000-023
Item no.: 248-501/000-024	Mini-WSB marking card; as card; not stretchable; plain; snap-on type; violet	www.wago.com/248-501/000-024
	Item no.: 248-502/000-024	www.wago.com/248-502/000-024
Mini-WSB marking card; as card; MARKED; 1 ... 10 (10x); not stretchable; Horizontal marking; snap-on type; violet		
	Item no.: 248-503/000-024	www.wago.com/248-503/000-024
Mini-WSB marking card; as card; MARKED; 11 ... 20 (10x); not stretchable; Horizontal marking; snap-on type; violet		

Subject to changes. Please also observe the further product documentation!



Item no.: 248-504

Mini-WSB marking card; as card; MARKED; 21 ... 30 (10x); not stretchable; Horizontal marking; snap-on type; white

www.wago.com/248-504

Item no.: 248-504/000-024

Mini-WSB marking card; as card; MARKED; 21 ... 30 (10x); not stretchable; Horizontal marking; snap-on type; violet

www.wago.com/248-504/000-024

Item no.: 248-505/000-024

Mini-WSB marking card; as card; MARKED; 31 ... 40 (10x); not stretchable; Horizontal marking; snap-on type; violet

www.wago.com/248-505/000-024

Item no.: 248-566

Mini-WSB marking card; as card; MARKED; 1 ... 50 (2x); not stretchable; Horizontal marking; snap-on type; white

www.wago.com/248-566

tools



Item no.: 210-720

Operating tool; Blade: 3.5 x 0.5 mm; with a partially insulated shaft

www.wago.com/210-720

End plate

Item no.: 859-525

End and intermediate plate; 1 mm thick; gray

www.wago.com/859-525

Jumper

Item no.: 859-402

Push-in type jumper bar; 2-way; Nominal current 18 A; insulated; light gray

www.wago.com/859-402

Item no.: 859-402/000-005

Push-in type jumper bar; 2-way; Nominal current 18 A; insulated; red

www.wago.com/859-402/000-005

Item no.: 859-402/000-006

Push-in type jumper bar; 2-way; Nominal current 18 A; insulated; blue

www.wago.com/859-402/000-006

Item no.: 859-402/000-029

Push-in type jumper bar; 2-way; Nominal current 18 A; insulated; yellow

www.wago.com/859-402/000-029

Item no.: 859-403

Push-in type jumper bar; 3-way; Nominal current 18 A; insulated; light gray

www.wago.com/859-403

Item no.: 859-403/000-005

Push-in type jumper bar; 3-way; Nominal current 18 A; insulated; red

www.wago.com/859-403/000-005



Item no.: 859-403/000-006

Push-in type jumper bar; 3-way; Nominal current 18 A; insulated; blue

www.wago.com/859-403/000-006



Item no.: 859-403/000-029

Push-in type jumper bar; 3-way; Nominal current 18 A; insulated; yellow

www.wago.com/859-403/000-029

Subject to changes. Please also observe the further product documentation!

WAGO Kontakttechnik GmbH & Co. KG

Hansastr. 27





32423 Minden

Phone: +49571 887-0 | Fax: +49571 887-169

Email: info.de@wago.com | Web: www.wago.com

Do you have any questions about our products?

We are always happy to take your call at +49 (571) 887-44222.

	Item no.: 859-404 Push-in type jumper bar; 4-way; Nominal current 18 A; insulated; light gray	www.wago.com/859-404
	Item no.: 859-404/000-005 Push-in type jumper bar; 4-way; Nominal current 18 A; insulated; red	www.wago.com/859-404/000-005
	Item no.: 859-404/000-006 Push-in type jumper bar; 4-way; Nominal current 18 A; insulated; blue	www.wago.com/859-404/000-006
	Item no.: 859-404/000-029 Push-in type jumper bar; 4-way; Nominal current 18 A; insulated; yellow	www.wago.com/859-404/000-029
	Item no.: 859-405 Push-in type jumper bar; 5-way; Nominal current 18 A; insulated; light gray	www.wago.com/859-405
	Item no.: 859-405/000-005 Push-in type jumper bar; 5-way; Nominal current 18 A; insulated; red	www.wago.com/859-405/000-005
	Item no.: 859-405/000-006 Push-in type jumper bar; 5-way; Nominal current 18 A; insulated; blue	www.wago.com/859-405/000-006
	Item no.: 859-405/000-029 Push-in type jumper bar; 5-way; Nominal current 18 A; insulated; yellow	www.wago.com/859-405/000-029
	Item no.: 859-406 Push-in type jumper bar; 6-way; Nominal current 18 A; insulated; light gray	www.wago.com/859-406
	Item no.: 859-406/000-005 Push-in type jumper bar; 6-way; Nominal current 18 A; insulated; red	www.wago.com/859-406/000-005
	Item no.: 859-406/000-006 Push-in type jumper bar; 6-way; Nominal current 18 A; insulated; blue	www.wago.com/859-406/000-006
	Item no.: 859-406/000-029 Push-in type jumper bar; 6-way; Nominal current 18 A; insulated; yellow	www.wago.com/859-406/000-029
	Item no.: 859-407 Push-in type jumper bar; 7-way; Nominal current 18 A; insulated; light gray	www.wago.com/859-407
	Item no.: 859-407/000-005 Push-in type jumper bar; 7-way; Nominal current 18 A; insulated; red	www.wago.com/859-407/000-005

Subject to changes. Please also observe the further product documentation!



Item no.: 859-407/000-006
Push-in type jumper bar; 7-way; Nominal current 18 A; insulated; blue

www.wago.com/859-407/000-006



Item no.: 859-407/000-029
Push-in type jumper bar; 7-way; Nominal current 18 A; insulated; yellow

www.wago.com/859-407/000-029



Item no.: 859-408
Push-in type jumper bar; 8-way; Nominal current 18 A; insulated; light gray

www.wago.com/859-408



Item no.: 859-408/000-005
Push-in type jumper bar; 8-way; Nominal current 18 A; insulated; red

www.wago.com/859-408/000-005



Item no.: 859-408/000-006
Push-in type jumper bar; 8-way; Nominal current 18 A; insulated; blue

www.wago.com/859-408/000-006

Item no.: 859-408/000-029
Push-in type jumper bar; 8-way; Nominal current 18 A; insulated; yellow

www.wago.com/859-408/000-029

Item no.: 859-409
Push-in type jumper bar; 9-way; Nominal current 18 A; insulated; light gray

www.wago.com/859-409

Item no.: 859-409/000-005
Push-in type jumper bar; 9-way; Nominal current 18 A; insulated; red

www.wago.com/859-409/000-005

Item no.: 859-409/000-006
Push-in type jumper bar; 9-way; Nominal current 18 A; insulated; blue

www.wago.com/859-409/000-006



Item no.: 859-409/000-029
Push-in type jumper bar; 9-way; Nominal current 18 A; insulated; yellow

www.wago.com/859-409/000-029

Item no.: 859-410
Push-in type jumper bar; 10-way; Nominal current 18 A; insulated; light gray

www.wago.com/859-410

Item no.: 859-410/000-005
Push-in type jumper bar; 10-way; Nominal current 18 A; insulated; red

www.wago.com/859-410/000-005

Item no.: 859-410/000-006
Push-in type jumper bar; 10-way; Nominal current 18 A; insulated; blue

www.wago.com/859-410/000-006

Item no.: 859-410/000-029
Push-in type jumper bar; 10-way; Nominal current 18 A; insulated; yellow

www.wago.com/859-410/000-029

Subject to changes. Please also observe the further product documentation!



Downloads

Documentation

Additional Information

Disposal; Electrical and electronic equipment, Packaging	V 1.0.0	pdf 265.8 kB	Download
--	---------	-----------------	----------

CAD/CAE-Data

CAE data

EPLAN Data Portal 792-800	URL	Download
WSCAD Universe 792-800	URL	Download

Installation Notes

Subject to changes. Please also observe the further product documentation!