

**Data sheet | Item number: 789-552**

Relay module; Nominal input voltage: 24 V AC/DC; 4 make contacts; Limiting continuous current: 4 A; Red status indicator; Module width: 18 mm; 2,50 mm<sup>2</sup>; gray

[www.wago.com/789-552](http://www.wago.com/789-552)



BOMcheck.net

Color: ■

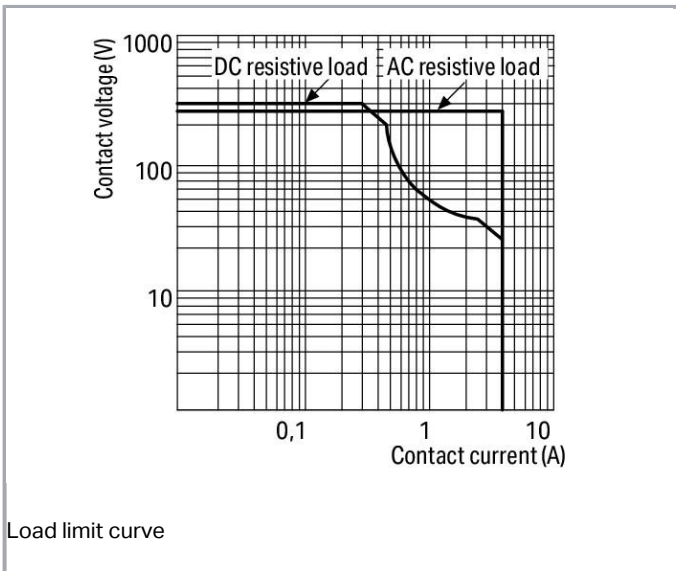
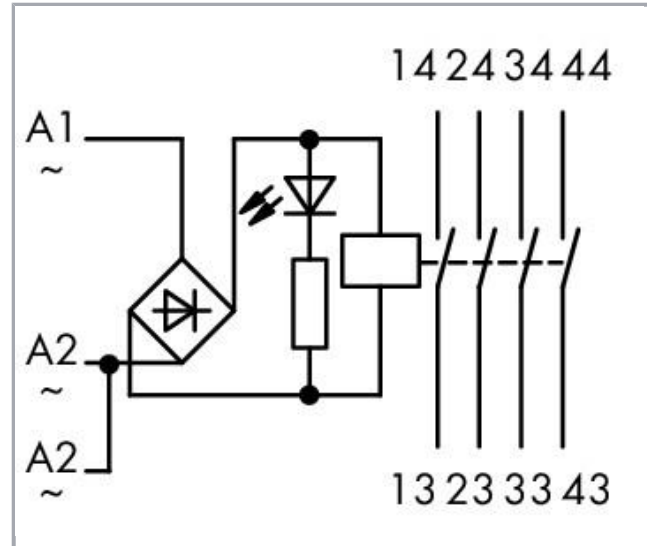

Subject to changes. Please also observe the further product documentation!

WAGO Kontakttechnik GmbH & Co. KG  
 Hansastr. 27  
 32423 Minden  
 Phone: +49571 887-0 | Fax: +49571 887-169  
 Email: [info.de@wago.com](mailto:info.de@wago.com) | Web: [www.wago.com](http://www.wago.com)

Do you have any questions about our products?  
 We are always happy to take your call at +49 (571) 887-44222.



## Item description

### Short description:

WAGO's 789 Series Switching Relays serve a wide variety of applications, from basic lighting control – homes, hotels and commercial structures – to comprehensive industrial control cabinets. Just 17.5 mm (0.689 inch) wide, the compact DIN-rail-mount enclosure is ideal for distribution boards and meter cabinets.

### Note:

To protect the relay coils and contacts, inductive loads must be dampened with an effective protection circuit.

## Data

### Technical Data

#### Control circuit

Nominal input voltage $U_N$	AC/DC 24 V
Input voltage range	-15 ... +10 %
Nominal input current at $U_N$	12 mA

#### Load circuit:

Number of make contacts/switch on contacts	4
Contact material (relay)	AgNi + Au
Limiting continuous current	4 A
Max. switching voltage	AC 250 V
Max. switching power (resistive)	AC 1000 VA; DC (see load limit curve)
Recommended minimum load	0,1 V / 0,1 mA
Pull-in time (typ.)	20 ms
Drop-out time (typ.)	20 ms
Bounce time (typ.)	1 ms
Mechanical life	$10 \times 10^6$ switching operations

#### Signaling

Status indication	Red LED
-------------------	---------

#### Safety and protection:

Rated voltage	230 V
Rated impulse voltage	2.5 kV

Subject to changes. Please also observe the further product documentation!



Pollution degree	2
Dielectric strength, control/load circuit (AC, 1 min)	1,5 kVrms
Dielectric strength open contact (AC, 1 min)	0,75 kVrms
Dielectric strength, load/load circuit (AC, 1 min)	1 kVrms
Protection class	IP20

### Connection data

Connection technology	CAGE CLAMP®
Solid conductor	0,2 ... 2,5 mm <sup>2</sup> / 24 ... 14 AWG
Fine-stranded conductor	0,2 ... 2,5 mm <sup>2</sup> / 24 ... 14 AWG
Strip length	9 ... 10 mm / 0.35 ... 0.39 inch

### Geometrical Data

Width	17,5 mm / 0.689 inch
Height from upper-edge of DIN-35 rail	55 mm / 2.165 inch
Depth	90 mm / 3.543 inch

### Mechanical data

Type of mounting	DIN-35 rail
------------------	-------------

### Material Data

Color	gray
Fire load	1.033 MJ
Weight	51.9 g

### Environmental Requirements

Surrounding air (operating) temperature at U <sub>N</sub>	-25 ... 40 °C
Surrounding air (storage) temperature	-40 ... 85 °C
Processing temperature	-25 ... +50 °C

### Standards and specifications

Standards/specifications	EN 60664-1; EN 61810-1
--------------------------	------------------------

### Commercial data

Product Group	6 (Interface Electronics)
---------------	---------------------------

Subject to changes. Please also observe the further product documentation!

WAGO Kontakttechnik GmbH & Co. KG  
 Hansastr. 27  
 32423 Minden  
 Phone: +49571 887-0 | Fax: +49571 887-169  
 Email: [info.de@wago.com](mailto:info.de@wago.com) | Web: [www.wago.com](http://www.wago.com)

Do you have any questions about our products?  
 We are always happy to take your call at +49 (571) 887-44222.

Packaging type	BOX
Country of origin	DE
GTIN	4017332929738
Customs Tariff No.	85364900990

## Counterpart

## Compatible products

### Jumper

<b>Item no.: 789-112</b> Push-in type jumper bar; 12-way; Nominal current 16 A; unplated; silver-colored	<a href="http://www.wago.com/789-112">www.wago.com/789-112</a>
---	--

### ferrule

<b>Item no.: 216-241</b> Ferrule; Sleeve for 0.5 mm <sup>2</sup> / 20 AWG; insulated; electro-tin plated; electrolytic copper; gastight crimped; acc. to DIN 46228, Part 4/09.90; white	<a href="http://www.wago.com/216-241">www.wago.com/216-241</a>
--	--



<b>Item no.: 216-242</b> Ferrule; Sleeve for 0.75 mm <sup>2</sup> / 18 AWG; insulated; electro-tin plated; electrolytic copper; gastight crimped; acc. to DIN 46228, Part 4/09.90; gray	<a href="http://www.wago.com/216-242">www.wago.com/216-242</a>
--	--



<b>Item no.: 216-243</b> Ferrule; Sleeve for 1 mm <sup>2</sup> / AWG 18; insulated; electro-tin plated; electrolytic copper; gastight crimped; acc. to DIN 46228, Part 4/09.90; red	<a href="http://www.wago.com/216-243">www.wago.com/216-243</a>
--	--

<b>Item no.: 216-244</b> Ferrule; Sleeve for 1.5 mm <sup>2</sup> / AWG 16; insulated; electro-tin plated; electrolytic copper; gastight crimped; acc. to DIN 46228, Part 4/09.90; black	<a href="http://www.wago.com/216-244">www.wago.com/216-244</a>
--	--

### tools



<b>Item no.: 210-720</b> Operating tool; Blade: 3.5 x 0.5 mm; with a partially insulated shaft	<a href="http://www.wago.com/210-720">www.wago.com/210-720</a>
---	--







### Marking accessories

 <b>Item no.: 2009-145</b> Mini-WSB Inline; for Smart Printer; 1700 pieces on roll; stretchable 5 - 5.2 mm; plain; snap-on type; white	<a href="http://www.wago.com/2009-145">www.wago.com/2009-145</a>
---	--











 <b>Item no.: 2009-145/000-002</b> Mini-WSB Inline; for Smart Printer; 1700 pieces on roll; stretchable 5 - 5.2 mm; plain; snap-on type; white /000-002	<a href="http://www.wago.com/2009-145">www.wago.com/2009-145</a>
--	--

 <b>Item no.: 2009-145/000-005</b> Mini-WSB Inline; for Smart Printer; 1700 pieces on roll; stretchable 5 - 5.2 mm; plain; snap-on type; red /000-005	<a href="http://www.wago.com/2009-145">www.wago.com/2009-145</a>
--	--

Subject to changes. Please also observe the further product documentation!

	<b>Item no.: 2009-145/000-006</b> Mini-WSB Inline; for Smart Printer; 1700 pieces on roll; stretchable 5 - 5.2 mm; plain; snap-on type; blue	<a href="http://www.wago.com/2009-145/000-006">www.wago.com/2009-145/000-006</a>
	<b>Item no.: 2009-145/000-007</b> Mini-WSB Inline; for Smart Printer; 1700 pieces on roll; stretchable 5 - 5.2 mm; plain; snap-on type; white	<a href="http://www.wago.com/2009-145/000-007">www.wago.com/2009-145/000-007</a>
	<b>Item no.: 2009-145/000-012</b> Mini-WSB Inline; for Smart Printer; 1700 pieces on roll; stretchable 5 - 5.2 mm; plain; snap-on type; orange	<a href="http://www.wago.com/2009-145/000-012">www.wago.com/2009-145/000-012</a>
	<b>Item no.: 2009-145/000-023</b> Mini-WSB Inline; for Smart Printer; 1700 pieces on roll; stretchable 5 - 5.2 mm; plain; snap-on type; green	<a href="http://www.wago.com/2009-145/000-023">www.wago.com/2009-145/000-023</a>
	<b>Item no.: 2009-145/000-024</b> Mini-WSB Inline; for Smart Printer; 1700 pieces on roll; stretchable 5 - 5.2 mm; plain; snap-on type; violet	<a href="http://www.wago.com/2009-145/000-024">www.wago.com/2009-145/000-024</a>
	<b>Item no.: 210-110</b> Fiber-tip pen	<a href="http://www.wago.com/210-110">www.wago.com/210-110</a>
	<b>Item no.: 248-450</b> Mini-WSB marking card; as card; MARKED; K1 - K10 (10x); not stretchable; Horizontal marking; snap-on type; white	<a href="http://www.wago.com/248-450">www.wago.com/248-450</a>
	<b>Item no.: 248-451</b> Mini-WSB marking card; as card; MARKED; K11 - K20 (10x); not stretchable; Horizontal marking; snap-on type; white	<a href="http://www.wago.com/248-451">www.wago.com/248-451</a>
	<b>Item no.: 248-452</b> Mini-WSB marking card; as card; MARKED; K (100x); not stretchable; Horizontal marking; snap-on type; white	<a href="http://www.wago.com/248-452">www.wago.com/248-452</a>
	<b>Item no.: 248-453</b> Mini-WSB marking card; as card; MARKED; U1, ... U10 (10x); not stretchable; Horizontal marking; snap-on type; white	<a href="http://www.wago.com/248-453">www.wago.com/248-453</a>
	<b>Item no.: 248-454</b> Mini-WSB marking card; as card; MARKED; U11 - U20 (10x); not stretchable; Horizontal marking; snap-on type; white	<a href="http://www.wago.com/248-454">www.wago.com/248-454</a>
	<b>Item no.: 248-455</b> Mini-WSB marking card; as card; MARKED; U 100 (10x); not stretchable; Horizontal marking; snap-on type; white	<a href="http://www.wago.com/248-455">www.wago.com/248-455</a>
	<b>Item no.: 248-501</b> Miniature WSB Quick marking system; plain; Marker width 5 mm; 10 strips with 10 markers per card	<a href="http://www.wago.com/248-501">www.wago.com/248-501</a>
	<b>Item no.: 248-501/000-002</b> Mini-WSB marking card; as card; not stretchable; plain; snap-on type; yellow	<a href="http://www.wago.com/248-501/000-002">www.wago.com/248-501/000-002</a>
	<b>Item no.: 248-501/000-005</b> Mini-WSB marking card; as card; not stretchable; plain; snap-on type; red	<a href="http://www.wago.com/248-501/000-005">www.wago.com/248-501/000-005</a>

Subject to changes. Please also observe the further product documentation!

	<b>Item no.: 248-501/000-006</b> Mini-WSB marking card; as card; not stretchable; plain; snap-on type; blue	<a href="http://www.wago.com/248-501/000-006">www.wago.com/248-501/000-006</a>
	<b>Item no.: 248-501/000-007</b> Mini-WSB marking card; as card; not stretchable; plain; snap-on type; gray	<a href="http://www.wago.com/248-501/000-007">www.wago.com/248-501/000-007</a>
	<b>Item no.: 248-501/000-012</b> Mini-WSB marking card; as card; not stretchable; plain; snap-on type; orange	<a href="http://www.wago.com/248-501/000-012">www.wago.com/248-501/000-012</a>
	<b>Item no.: 248-501/000-017</b> Mini-WSB marking card; as card; not stretchable; plain; snap-on type; light green	<a href="http://www.wago.com/248-501/000-017">www.wago.com/248-501/000-017</a>
	<b>Item no.: 248-501/000-023</b> Mini-WSB marking card; as card; not stretchable; plain; snap-on type; green	<a href="http://www.wago.com/248-501/000-023">www.wago.com/248-501/000-023</a>
	<b>Item no.: 248-501/000-024</b> Mini-WSB marking card; as card; not stretchable; plain; snap-on type; violet	<a href="http://www.wago.com/248-501/000-024">www.wago.com/248-501/000-024</a>
	<b>Item no.: 248-502</b> Mini-WSB marking card; as card; MARKED; 1 ... 10 (10x); not stretchable; Horizontal marking; snap-on type; white	<a href="http://www.wago.com/248-502">www.wago.com/248-502</a>
	<b>Item no.: 248-502/000-024</b> Mini-WSB marking card; as card; MARKED; 1 ... 10 (10x); not stretchable; Horizontal marking; snap-on type; violet	<a href="http://www.wago.com/248-502/000-024">www.wago.com/248-502/000-024</a>
	<b>Item no.: 248-503</b> Mini-WSB marking card; as card; MARKED; 11 ... 20 (10x); not stretchable; Horizontal marking; snap-on type; white	<a href="http://www.wago.com/248-503">www.wago.com/248-503</a>
	<b>Item no.: 248-503/000-024</b> Mini-WSB marking card; as card; MARKED; 11 ... 20 (10x); not stretchable; Horizontal marking; snap-on type; violet	<a href="http://www.wago.com/248-503/000-024">www.wago.com/248-503/000-024</a>
	<b>Item no.: 248-504</b> Mini-WSB marking card; as card; MARKED; 21 ... 30 (10x); not stretchable; Horizontal marking; snap-on type; white	<a href="http://www.wago.com/248-504">www.wago.com/248-504</a>
	<b>Item no.: 248-504/000-024</b> Mini-WSB marking card; as card; MARKED; 21 ... 30 (10x); not stretchable; Horizontal marking; snap-on type; violet	<a href="http://www.wago.com/248-504/000-024">www.wago.com/248-504/000-024</a>
	<b>Item no.: 248-505/000-024</b> Mini-WSB marking card; as card; MARKED; 31 ... 40 (10x); not stretchable; Horizontal marking; snap-on type; violet	<a href="http://www.wago.com/248-505/000-024">www.wago.com/248-505/000-024</a>
	<b>Item no.: 248-506</b> Mini-WSB marking card; as card; MARKED; 41 ... 50 (10x); not stretchable; Horizontal marking; snap-on type; white	<a href="http://www.wago.com/248-506">www.wago.com/248-506</a>

Subject to changes. Please also observe the further product documentation!

Item no.: 248-566

Mini-WSB marking card; as card; MARKED; 1 ... 50 (2x); not stretchable; Horizontal marking; snap-on type; white

[www.wago.com/248-566](http://www.wago.com/248-566)

## Downloads

### Documentation

#### Instruction Leaflet

pdf  
1.3 MB  
[Download](#)

### Additional Information

Disposal; Electrical and electronic equipment, Packaging

V 1.0.0

pdf  
265.8 kB  
[Download](#)

## CAD/CAE-Data

### CAD data

2D/3D Models 789-552

URL  
[Download](#)

### CAE data

EPLAN Data Portal 789-552

URL  
[Download](#)

WSCAD Universe 789-552

URL  
[Download](#)

## Installation Notes

### Inserting a conductor

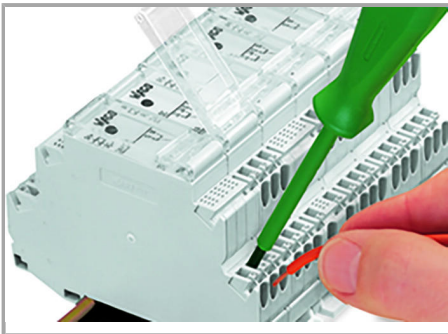

Connection of conductor.

Subject to changes. Please also observe the further product documentation!

WAGO Kontakttechnik GmbH & Co. KG

Hansastr. 27

32423 Minden

Phone: +49571 887-0 | Fax: +49571 887-169

Email: [info.de@wago.com](mailto:info.de@wago.com) | Web: [www.wago.com](http://www.wago.com)

Do you have any questions about our products?

We are always happy to take your call at +49 (571) 887-44222.

### Jumpered

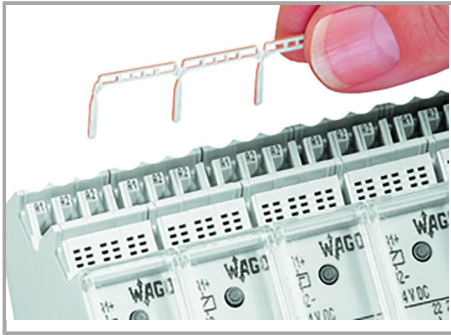

Easy commoning using adjacent jumpers

### Marking

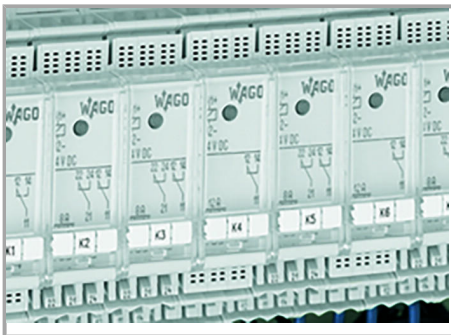

Marking using miniature WSB quick marking card

Subject to changes. Please also observe the further product documentation!