

Data sheet | Item number: 789-304

Relay module; Nominal input voltage: 24 VDC; 1 changeover contact;
Limiting continuous current: 12 A; Red status indicator; Module width: 18
mm; 2,50 mm²; gray

www.wago.com/789-304

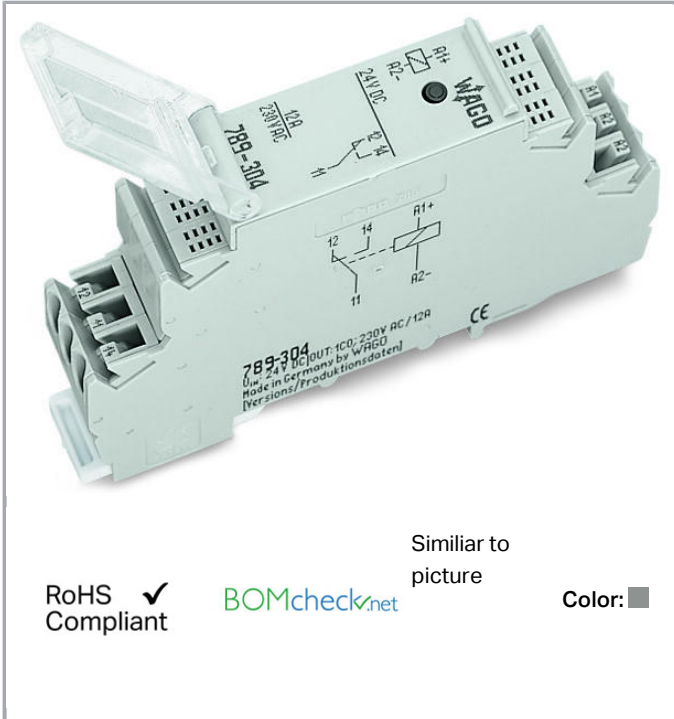

RoHS
Compliant ✓

BOMcheck.net

Similar to
picture

Color: ■

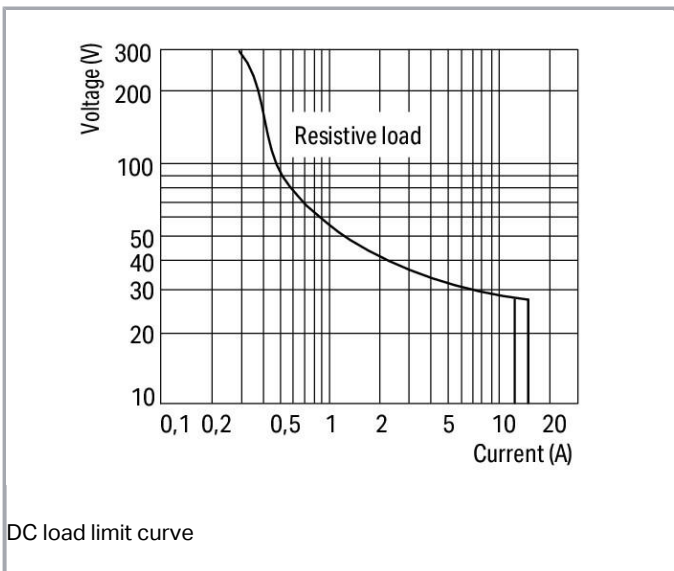
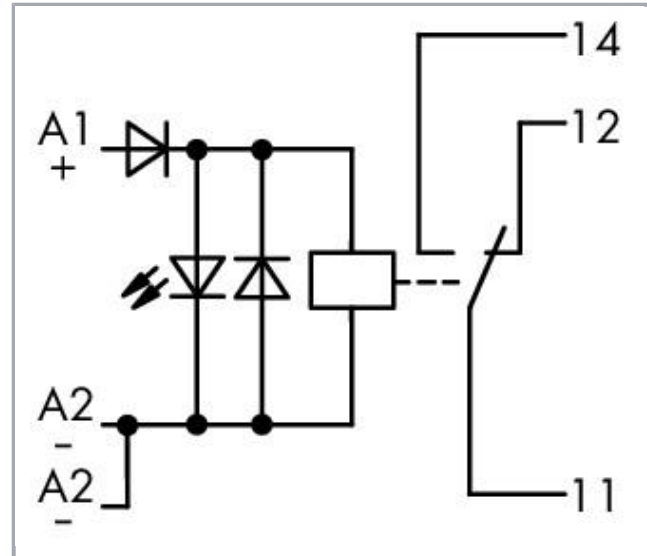

DC load limit curve

Item description

Subject to changes. Please also observe the further product documentation!

WAGO Kontakttechnik GmbH & Co. KG
Hansastr. 27
32423 Minden
Phone: +49571 887-0 | Fax: +49571 887-169
Email: info.de@wago.com | Web: www.wago.com

Do you have any questions about our products?
We are always happy to take your call at +49 (571) 887-44222.

**Short description:**

WAGO's 789 Series Switching Relays serve a wide variety of applications, from basic lighting control – homes, hotels and commercial structures – to comprehensive industrial control cabinets. Just 17.5 mm (0.689 inch) wide, the compact DIN-rail-mount enclosure is ideal for distribution boards and meter cabinets.

Note:

To protect the relay coils and contacts, inductive loads must be dampened with an effective protection circuit.

Data**Technical Data****Control circuit**

Nominal input voltage U_N	DC 24 V
Input voltage range	-15 ... +10 %
Nominal input current at U_N	19 mA

Load circuit:

Number of changeover/switchover contacts	1
Contact material (relay)	AgNi 90/10
Limiting continuous current	12 A
Max. make current (resistive)	(AC) 30 A / 4 s
Max. switching voltage	AC 250 V
Max. switching power (resistive)	AC 3000 VA; DC (see load limit curve)
Recommended minimum load	12 V / 10 mA
Pull-in time (typ.)	8 ms
Drop-out time (typ.)	6 ms
Bounce time (typ.)	6 ms
Mechanical life	3×10^6 switching operations

Signaling

Status indication	Red LED
-------------------	---------

Safety and protection:

Rated voltage	250 V
Rated impulse voltage	4 kV

Subject to changes. Please also observe the further product documentation!



Pollution degree	2
Dielectric strength, control/load circuit (AC, 1 min)	5 kVrms
Dielectric strength open contact (AC, 1 min)	1 kVrms
Protection class	IP20

Connection data

Connection technology	CAGE CLAMP®
Solid conductor	0,2 ... 2,5 mm ² / 24 ... 14 AWG
Fine-stranded conductor	0,2 ... 2,5 mm ² / 24 ... 14 AWG
Strip length	9 ... 10 mm / 0.35 ... 0.39 inch

Geometrical Data

Width	17,5 mm / 0.689 inch
Height from upper-edge of DIN-35 rail	55 mm / 2.165 inch
Depth	90 mm / 3.543 inch

Mechanical data

Type of mounting	DIN-35 rail
------------------	-------------

Material Data

Color	gray
Fire load	0.733 MJ
Weight	50.5 g

Environmental Requirements

Surrounding air (operating) temperature at U _N	-25 ... 40 °C
Surrounding air (storage) temperature	-40 ... 85 °C
Processing temperature	-25 ... +50 °C

Standards and specifications

Standards/specifications	EN 60664-1
--------------------------	------------

Commercial data

Product Group	6 (Interface Electronics)
Packaging type	BOX



Subject to changes. Please also observe the further product documentation!

Country of origin	DE
GTIN	4045454313005
Customs Tariff No.	85364900990

Counterpart

Compatible products





ferrule

	Item no.: 216-241 Ferrule; Sleeve for 0.5 mm ² / 20 AWG; insulated; electro-tin plated; electrolytic copper; gastight crimped; acc. to DIN 46228, Part 4/09.90; white	www.wago.com/216-241
	Item no.: 216-242 Ferrule; Sleeve for 0.75 mm ² / 18 AWG; insulated; electro-tin plated; electrolytic copper; gastight crimped; acc. to DIN 46228, Part 4/09.90; gray	www.wago.com/216-242
	Item no.: 216-243 Ferrule; Sleeve for 1 mm ² / AWG 18; insulated; electro-tin plated; electrolytic copper; gastight crimped; acc. to DIN 46228, Part 4/09.90; red	www.wago.com/216-243
	Item no.: 216-244 Ferrule; Sleeve for 1.5 mm ² / AWG 16; insulated; electro-tin plated; electrolytic copper; gastight crimped; acc. to DIN 46228, Part 4/09.90; black	www.wago.com/216-244















Jumper

	Item no.: 789-112 Push-in type jumper bar; 12-way; Nominal current 16 A; unplated; silver-colored	www.wago.com/789-112
--	---	--

Marking accessories

	Item no.: 2009-145 Mini-WSB Inline; for Smart Printer; 1700 pieces on roll; stretchable 5 - 5.2 mm; plain; snap-on type; white	www.wago.com/2009-145
	Item no.: 2009-145/000-002 Mini-WSB Inline; for Smart Printer; 1700 pieces on roll; stretchable 5 - 5.2 mm; plain; snap-on type; white /000-002	www.wago.com/2009-145
	Item no.: 2009-145/000-005 Mini-WSB Inline; for Smart Printer; 1700 pieces on roll; stretchable 5 - 5.2 mm; plain; snap-on type; red /000-005	www.wago.com/2009-145
	Item no.: 2009-145/000-006 Mini-WSB Inline; for Smart Printer; 1700 pieces on roll; stretchable 5 - 5.2 mm; plain; snap-on type; blue /000-006	www.wago.com/2009-145
	Item no.: 2009-145/000-007 Mini-WSB Inline; for Smart Printer; 1700 pieces on roll; stretchable 5 - 5.2 mm; plain; snap-on type; white /000-007	www.wago.com/2009-145

Subject to changes. Please also observe the further product documentation!

	Item no.: 2009-145/000-012 Mini-WSB Inline; for Smart Printer; 1700 pieces on roll; stretchable 5 - 5.2 mm; plain; snap-on type; orange	www.wago.com/2009-145/000-012
	Item no.: 2009-145/000-023 Mini-WSB Inline; for Smart Printer; 1700 pieces on roll; stretchable 5 - 5.2 mm; plain; snap-on type; green	www.wago.com/2009-145/000-023
	Item no.: 2009-145/000-024 Mini-WSB Inline; for Smart Printer; 1700 pieces on roll; stretchable 5 - 5.2 mm; plain; snap-on type; violet	www.wago.com/2009-145/000-024
	Item no.: 210-110 Fiber-tip pen	www.wago.com/210-110
	Item no.: 248-450 Mini-WSB marking card; as card; MARKED; K1 - K10 (10x); not stretchable; Horizontal marking; snap-on type; white	www.wago.com/248-450
	Item no.: 248-451 Mini-WSB marking card; as card; MARKED; K11 - K20 (10x); not stretchable; Horizontal marking; snap-on type; white	www.wago.com/248-451
	Item no.: 248-452 Mini-WSB marking card; as card; MARKED; K (100x); not stretchable; Horizontal marking; snap-on type; white	www.wago.com/248-452
	Item no.: 248-453 Mini-WSB marking card; as card; MARKED; U1, ... U10 (10x); not stretchable; Horizontal marking; snap-on type; white	www.wago.com/248-453
	Item no.: 248-454 Mini-WSB marking card; as card; MARKED; U11 - U20 (10x); not stretchable; Horizontal marking; snap-on type; white	www.wago.com/248-454
	Item no.: 248-455 Mini-WSB marking card; as card; MARKED; U 100 (10x); not stretchable; Horizontal marking; snap-on type; white	www.wago.com/248-455
	Item no.: 248-501 Miniature WSB Quick marking system; plain; Marker width 5 mm; 10 strips with 10 markers per card	www.wago.com/248-501
	Item no.: 248-501/000-002 Mini-WSB marking card; as card; not stretchable; plain; snap-on type; yellow	www.wago.com/248-501/000-002
	Item no.: 248-501/000-005 Mini-WSB marking card; as card; not stretchable; plain; snap-on type; red	www.wago.com/248-501/000-005
	Item no.: 248-501/000-006 Mini-WSB marking card; as card; not stretchable; plain; snap-on type; blue	www.wago.com/248-501/000-006
	Item no.: 248-501/000-007 Mini-WSB marking card; as card; not stretchable; plain; snap-on type; gray	www.wago.com/248-501/000-007

Subject to changes. Please also observe the further product documentation!



Item no.: 248-501/000-012
 Mini-WSB marking card; as card; not stretchable; plain; snap-on type; orange
 www.wago.com/248-501/000-012

Item no.: 248-501/000-017
 Mini-WSB marking card; as card; not stretchable; plain; snap-on type; light green
 www.wago.com/248-501/000-017



Item no.: 248-501/000-023
 Mini-WSB marking card; as card; not stretchable; plain; snap-on type; green
 www.wago.com/248-501/000-023



Item no.: 248-501/000-024
 Mini-WSB marking card; as card; not stretchable; plain; snap-on type; violet
 www.wago.com/248-501/000-024



Item no.: 248-502
 Mini-WSB marking card; as card; MARKED; 1 ... 10 (10x); not stretchable; Horizontal marking; snap-on type; white
 www.wago.com/248-502



Item no.: 248-502/000-024
 Mini-WSB marking card; as card; MARKED; 1 ... 10 (10x); not stretchable; Horizontal marking; snap-on type; violet
 www.wago.com/248-502/000-024

Item no.: 248-503
 Mini-WSB marking card; as card; MARKED; 11 ... 20 (10x); not stretchable; Horizontal marking; snap-on type; white
 www.wago.com/248-503



Item no.: 248-503/000-024
 Mini-WSB marking card; as card; MARKED; 11 ... 20 (10x); not stretchable; Horizontal marking; snap-on type; violet
 www.wago.com/248-503/000-024

Item no.: 248-504
 Mini-WSB marking card; as card; MARKED; 21 ... 30 (10x); not stretchable; Horizontal marking; snap-on type; white
 www.wago.com/248-504



Item no.: 248-504/000-024
 Mini-WSB marking card; as card; MARKED; 21 ... 30 (10x); not stretchable; Horizontal marking; snap-on type; violet
 www.wago.com/248-504/000-024

Item no.: 248-505/000-024
 Mini-WSB marking card; as card; MARKED; 31 ... 40 (10x); not stretchable; Horizontal marking; snap-on type; violet
 www.wago.com/248-505/000-024

Item no.: 248-506
 Mini-WSB marking card; as card; MARKED; 41 ... 50 (10x); not stretchable; Horizontal marking; snap-on type; white
 www.wago.com/248-506

Item no.: 248-566
 Mini-WSB marking card; as card; MARKED; 1 ... 50 (2x); not stretchable; Horizontal marking; snap-on type; white
 www.wago.com/248-566

tools

Item no.: 210-720
 Operating tool; Blade: 3.5 x 0.5 mm; with a partially insulated shaft
 www.wago.com/210-720

Subject to changes. Please also observe the further product documentation!

Downloads

Documentation

Instruction Leaflet

pdf
1.3 MB

Download

Additional Information

Disposal; Electrical and electronic equipment, Packaging

V 1.0.0

pdf
265.8 kB

Download

CAD/CAE-Data

CAD data

2D/3D Models 789-304

URL

Download

CAE data

EPLAN Data Portal 789-304

URL

Download

WSCAD Universe 789-304

URL

Download

Installation Notes

Inserting a conductor

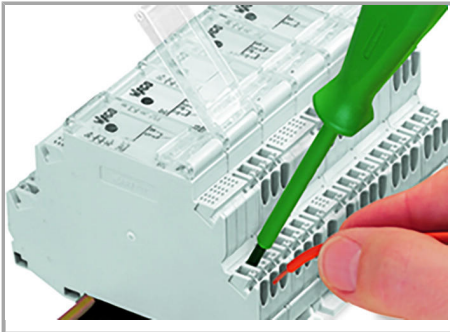

Connection of conductor.

Jumpered

Subject to changes. Please also observe the further product documentation!

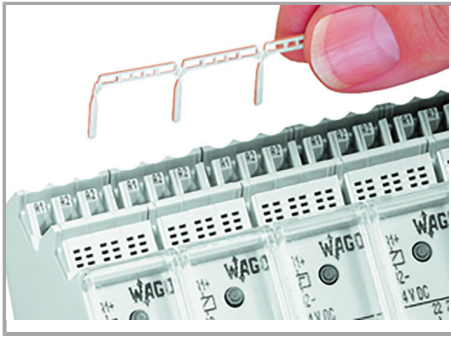

Easy commoning using adjacent jumpers

Marking

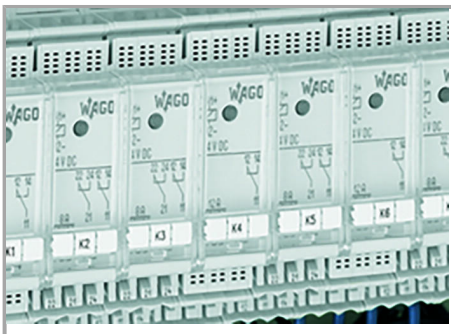

Marking using miniature WSB quick marking card

Subject to changes. Please also observe the further product documentation!