

**Data sheet | Item number: 789-1341**

Relay module; Nominal input voltage: 24 VDC; 1 changeover contact;  
Limiting continuous current: 12 A; with manual operation; Red status  
indicator; Module width: 18 mm; 2,50 mm<sup>2</sup>

[www.wago.com/789-1341](http://www.wago.com/789-1341)

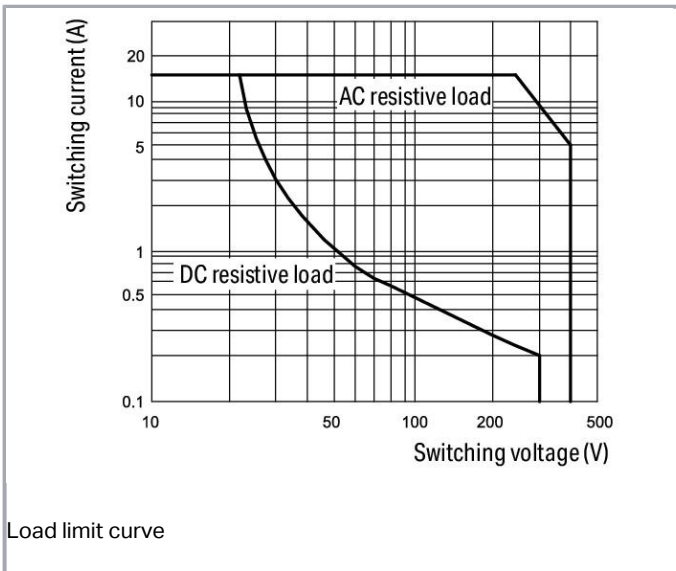
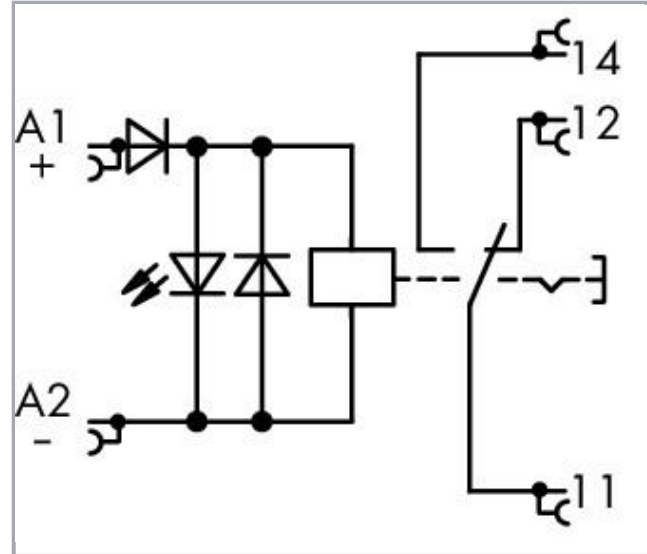

Subject to changes. Please also observe the further product documentation!

WAGO Kontakttechnik GmbH & Co. KG  
Hansastr. 27  
32423 Minden  
Phone: +49571 887-0 | Fax: +49571 887-169  
Email: [info.de@wago.com](mailto:info.de@wago.com) | Web: [www.wago.com](http://www.wago.com)

Do you have any questions about our products?  
We are always happy to take your call at +49 (571) 887-44222.



## Item description

### Note:

Inductive loads have to be attenuated by an appropriate protective circuit in order to protect relay coils and contacts.

## Data

### Technical Data

#### Control circuit

Nominal input voltage $U_N$	DC 24 V
Input voltage range	$\pm 10\%$
Nominal input current at $U_N$	17 mA

#### Load circuit:

Number of changeover/switchover contacts	1
Contact material (relay)	AgNi
Limiting continuous current	12 A
Max. make current (resistive)	(AC) 30 A / 0.02 s; (AC) 24 A / 4 s
Max. switching voltage	AC 250 V
Max. switching power (resistive)	AC 3000 VA; DC see load limit curve
Recommended minimum load	12 V / 10 mA
Pull-in time (typ.)	15 ms
Drop-out time (typ.)	8 ms
Bounce time (typ.)	6 ms
Mechanical life	$5 \times 10^6$ switching operations

#### Signaling

Status indication	LED red
-------------------	---------

#### Safety and protection:

Rated voltage	250 V
Rated impulse voltage	4 kV
Pollution degree	2
Dielectric strength, control/load circuit (AC, 1 min)	3.5 kVrms

Subject to changes. Please also observe the further product documentation!



Dielectric strength open contact (AC, 1 min)	1 kVrms
Protection class	IP20

### Connection data

Connection technology	CAGE CLAMP®
Solid conductor	0.2 ... 2.5 mm <sup>2</sup> / 24 ... 14 AWG
Fine-stranded conductor	0.2 ... 2.5 mm <sup>2</sup> / 24 ... 14 AWG
Strip length	9 ... 10 mm / 0.35 ... 0.39 inch

### Geometrical Data

Width	17.5 mm / 0.689 inch
Height from upper-edge of DIN-35 rail	55 mm / 2.165 inch
Depth	90 mm / 3.543 inch

### Mechanical data

Type of mounting	DIN-35 rail
------------------	-------------

### Material Data

Fire load	0.879 MJ
Weight	50.8 g

### Environmental Requirements

Surrounding air (operating) temperature at U <sub>N</sub>	-25 ... 50 °C
Surrounding air (storage) temperature	-40 ... 70 °C
Processing temperature	-25 ... +50 °C

### Standards and specifications

Standards/specifications	EN 60664-1
--------------------------	------------

### Commercial data









Product Group	6 (Interface Electronics)
Packaging type	BOX
Country of origin	DE
GTIN	4050821386728
Customs Tariff No.	85364900990

Subject to changes. Please also observe the further product documentation!

## Counterpart

## Compatible products

### Marking accessories

	<b>Item no.: 2009-145</b> Mini-WSB Inline; for Smart Printer; 1700 pieces on roll; stretchable 5 - 5.2 mm; plain; snap-on type; white	<a href="http://www.wago.com/2009-145">www.wago.com/2009-145</a>
	<b>Item no.: 2009-145/000-002</b> Mini-WSB Inline; for Smart Printer; 1700 pieces on roll; stretchable 5 - 5.2 mm; plain; snap-on type; white	<a href="http://www.wago.com/2009-145/000-002">www.wago.com/2009-145/000-002</a>
	<b>Item no.: 2009-145/000-005</b> Mini-WSB Inline; for Smart Printer; 1700 pieces on roll; stretchable 5 - 5.2 mm; plain; snap-on type; red	<a href="http://www.wago.com/2009-145/000-005">www.wago.com/2009-145/000-005</a>
	<b>Item no.: 2009-145/000-006</b> Mini-WSB Inline; for Smart Printer; 1700 pieces on roll; stretchable 5 - 5.2 mm; plain; snap-on type; blue	<a href="http://www.wago.com/2009-145/000-006">www.wago.com/2009-145/000-006</a>
	<b>Item no.: 2009-145/000-007</b> Mini-WSB Inline; for Smart Printer; 1700 pieces on roll; stretchable 5 - 5.2 mm; plain; snap-on type; white	<a href="http://www.wago.com/2009-145/000-007">www.wago.com/2009-145/000-007</a>
	<b>Item no.: 2009-145/000-012</b> Mini-WSB Inline; for Smart Printer; 1700 pieces on roll; stretchable 5 - 5.2 mm; plain; snap-on type; orange	<a href="http://www.wago.com/2009-145/000-012">www.wago.com/2009-145/000-012</a>
	<b>Item no.: 2009-145/000-023</b> Mini-WSB Inline; for Smart Printer; 1700 pieces on roll; stretchable 5 - 5.2 mm; plain; snap-on type; green	<a href="http://www.wago.com/2009-145/000-023">www.wago.com/2009-145/000-023</a>
	<b>Item no.: 2009-145/000-024</b> Mini-WSB Inline; for Smart Printer; 1700 pieces on roll; stretchable 5 - 5.2 mm; plain; snap-on type; violet	<a href="http://www.wago.com/2009-145/000-024">www.wago.com/2009-145/000-024</a>
	<b>Item no.: 210-110</b> Fiber-tip pen	<a href="http://www.wago.com/210-110">www.wago.com/210-110</a>
	<b>Item no.: 248-450</b> Mini-WSB marking card; as card; MARKED; K1 - K10 (10x); not stretchable; Horizontal marking; snap-on type; white	<a href="http://www.wago.com/248-450">www.wago.com/248-450</a>
	<b>Item no.: 248-451</b> Mini-WSB marking card; as card; MARKED; K11 - K20 (10x); not stretchable; Horizontal marking; snap-on type; white	<a href="http://www.wago.com/248-451">www.wago.com/248-451</a>
	<b>Item no.: 248-452</b>	

Subject to changes. Please also observe the further product documentation!

Mini-WSB marking card; as card; MARKED; K (100x); not stretchable; Horizontal marking; snap-on type; white [www.wago.com/248-452](http://www.wago.com/248-452)



**Item no.: 248-453**

Mini-WSB marking card; as card; MARKED; U1, ... U10 (10x); not stretchable; Horizontal marking; snap-on type; white [www.wago.com/248-453](http://www.wago.com/248-453)



**Item no.: 248-454**

Mini-WSB marking card; as card; MARKED; U11 - U20 (10x); not stretchable; Horizontal marking; snap-on type; white [www.wago.com/248-454](http://www.wago.com/248-454)

**Item no.: 248-455**

Mini-WSB marking card; as card; MARKED; U 100 (10x); not stretchable; Horizontal marking; snap-on type; white [www.wago.com/248-455](http://www.wago.com/248-455)

**Item no.: 248-501**

Miniature WSB Quick marking system; plain; Marker width 5 mm; 10 strips with 10 markers per card [www.wago.com/248-501](http://www.wago.com/248-501)

**Item no.: 248-501/000-002**

Mini-WSB marking card; as card; not stretchable; plain; snap-on type; yellow [www.wago.com/248-501/000-002](http://www.wago.com/248-501/000-002)

**Item no.: 248-501/000-005**

Mini-WSB marking card; as card; not stretchable; plain; snap-on type; red [www.wago.com/248-501/000-005](http://www.wago.com/248-501/000-005)



**Item no.: 248-501/000-006**

Mini-WSB marking card; as card; not stretchable; plain; snap-on type; blue [www.wago.com/248-501/000-006](http://www.wago.com/248-501/000-006)



**Item no.: 248-501/000-007**

Mini-WSB marking card; as card; not stretchable; plain; snap-on type; gray [www.wago.com/248-501/000-007](http://www.wago.com/248-501/000-007)



**Item no.: 248-501/000-012**

Mini-WSB marking card; as card; not stretchable; plain; snap-on type; orange [www.wago.com/248-501/000-012](http://www.wago.com/248-501/000-012)

**Item no.: 248-501/000-017**

Mini-WSB marking card; as card; not stretchable; plain; snap-on type; light green [www.wago.com/248-501/000-017](http://www.wago.com/248-501/000-017)



**Item no.: 248-501/000-023**

Mini-WSB marking card; as card; not stretchable; plain; snap-on type; green [www.wago.com/248-501/000-023](http://www.wago.com/248-501/000-023)

**Item no.: 248-501/000-024**

Mini-WSB marking card; as card; not stretchable; plain; snap-on type; violet [www.wago.com/248-501/000-024](http://www.wago.com/248-501/000-024)



**Item no.: 248-502**

Mini-WSB marking card; as card; MARKED; 1 ... 10 (10x); not stretchable; Horizontal marking; snap-on type; white [www.wago.com/248-502](http://www.wago.com/248-502)

**Item no.: 248-502/000-024**

Subject to changes. Please also observe the further product documentation!

WAGO Kontakttechnik GmbH & Co. KG

Hansastr. 27

32423 Minden

Phone: +49571 887-0 | Fax: +49571 887-169

Email: [info.de@wago.com](mailto:info.de@wago.com) | Web: [www.wago.com](http://www.wago.com)

Do you have any questions about our products?

We are always happy to take your call at +49 (571) 887-44222.



Mini-WSB marking card; as card; MARKED; 1 ... 10 (10x); not stretchable; Horizontal marking; snap-on type; violet

[www.wago.com/248-502/000-024](http://www.wago.com/248-502/000-024)



**Item no.: 248-503**

Mini-WSB marking card; as card; MARKED; 11 ... 20 (10x); not stretchable; Horizontal marking; snap-on type; white

[www.wago.com/248-503](http://www.wago.com/248-503)



**Item no.: 248-503/000-024**

Mini-WSB marking card; as card; MARKED; 11 ... 20 (10x); not stretchable; Horizontal marking; snap-on type; violet

[www.wago.com/248-503/000-024](http://www.wago.com/248-503/000-024)



**Item no.: 248-504**

Mini-WSB marking card; as card; MARKED; 21 ... 30 (10x); not stretchable; Horizontal marking; snap-on type; white

[www.wago.com/248-504](http://www.wago.com/248-504)

**Item no.: 248-504/000-024**

Mini-WSB marking card; as card; MARKED; 21 ... 30 (10x); not stretchable; Horizontal marking; snap-on type; violet

[www.wago.com/248-504/000-024](http://www.wago.com/248-504/000-024)



**Item no.: 248-505/000-024**

Mini-WSB marking card; as card; MARKED; 31 ... 40 (10x); not stretchable; Horizontal marking; snap-on type; violet

[www.wago.com/248-505/000-024](http://www.wago.com/248-505/000-024)

**Item no.: 248-506**

Mini-WSB marking card; as card; MARKED; 41 ... 50 (10x); not stretchable; Horizontal marking; snap-on type; white

[www.wago.com/248-506](http://www.wago.com/248-506)

**Item no.: 248-566**

Mini-WSB marking card; as card; MARKED; 1 ... 50 (2x); not stretchable; Horizontal marking; snap-on type; white

[www.wago.com/248-566](http://www.wago.com/248-566)

**tools**



**Item no.: 210-720**

Operating tool; Blade: 3.5 x 0.5 mm; with a partially insulated shaft

[www.wago.com/210-720](http://www.wago.com/210-720)

**Jumper**

**Item no.: 789-112**

Push-in type jumper bar; 12-way; Nominal current 16 A; unplated; silver-colored

[www.wago.com/789-112](http://www.wago.com/789-112)

**ferrule**

**Item no.: 216-241**

Ferrule; Sleeve for 0.5 mm<sup>2</sup> / 20 AWG; insulated; electro-tin plated; electrolytic copper; gastight crimped; acc. to DIN 46228, Part 4/09.90; white

[www.wago.com/216-241](http://www.wago.com/216-241)



**Item no.: 216-242**

Ferrule; Sleeve for 0.75 mm<sup>2</sup> / 18 AWG; insulated; electro-tin plated; electrolytic copper; gastight crimped; acc. to DIN 46228, Part 4/09.90; gray

[www.wago.com/216-242](http://www.wago.com/216-242)



**Item no.: 216-243**

Ferrule; Sleeve for 1 mm<sup>2</sup> / AWG 18; insulated; electro-tin plated; electrolytic copper; gastight crimped; acc. to DIN 46228, Part 4/09.90; red

[www.wago.com/216-243](http://www.wago.com/216-243)

**Item no.: 216-244**

Ferrule; Sleeve for 1.5 mm<sup>2</sup> / AWG 16; insulated; electro-tin plated; electrolytic copper; gastight crimped; acc. to DIN 46228, Part 4/09.90; black

[www.wago.com/216-244](http://www.wago.com/216-244)

Subject to changes. Please also observe the further product documentation!

## Downloads

### Documentation

#### Instruction Leaflet

pdf  
1.3 MB

Download

---

### Additional Information

Disposal; Electrical and electronic equipment, Packaging

V 1.0.0

pdf  
265.8 kB

Download

---

## CAD/CAE-Data

### CAE data

EPLAN Data Portal 789-1341

URL

Download

WSCAD Universe 789-1341

URL

Download

---

## Installation Notes

### Inserting a conductor

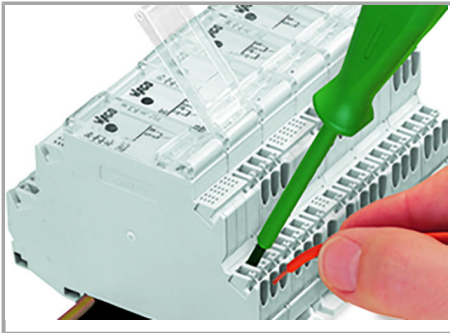

Connection of conductor.

### Jumpered

Subject to changes. Please also observe the further product documentation!

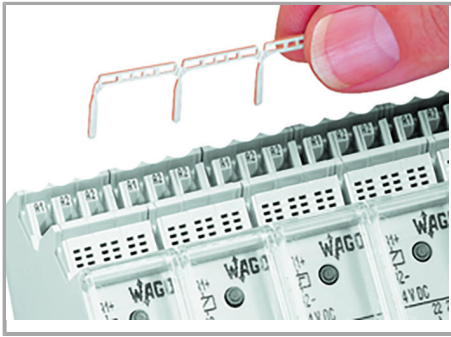

Easy commoning using adjacent jumpers

### Marking

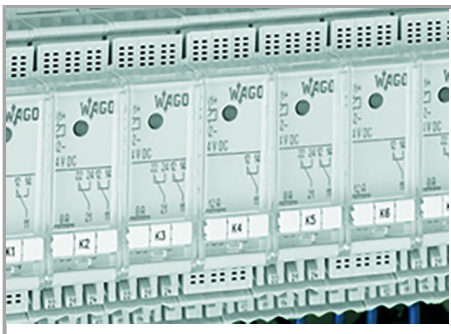

Marking using miniature WSB quick marking card

Subject to changes. Please also observe the further product documentation!