

Data sheet | Item number: 788-701

Solid-state relay module; Nominal input voltage: 24 VDC; Output voltage range: 3 ... 30 VDC; Limiting continuous current: 5 A; 2-wire connection; Red status indicator; Module width: 15 mm; gray

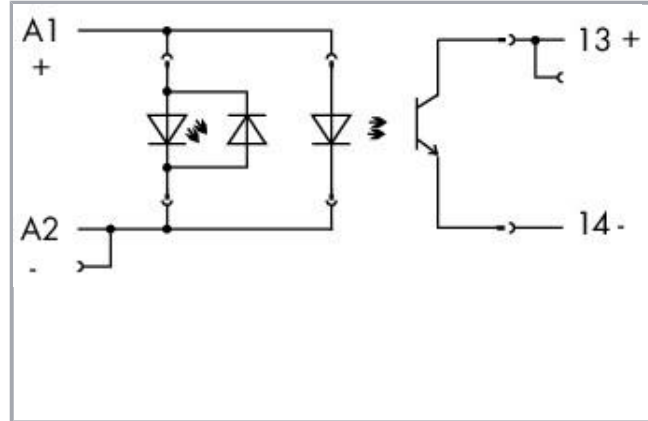

www.wago.com/788-701

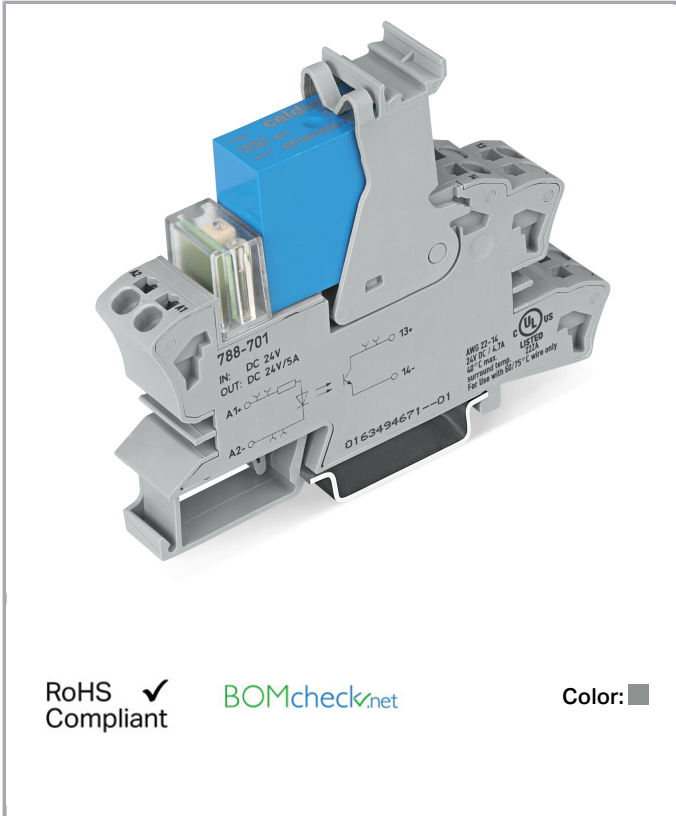

Subject to changes. Please also observe the further product documentation!

WAGO Kontakttechnik GmbH & Co. KG
Hansastr. 27
32423 Minden
Phone: +49571 887-0 | Fax: +49571 887-169
Email: info.de@wago.com | Web: www.wago.com

Do you have any questions about our products?
We are always happy to take your call at +49 (571) 887-44222.

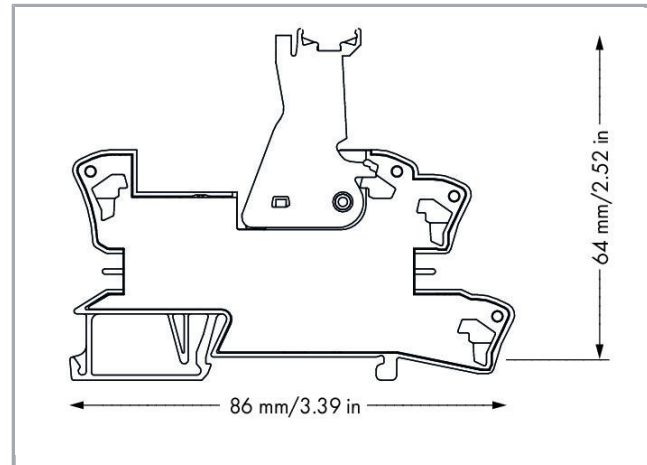
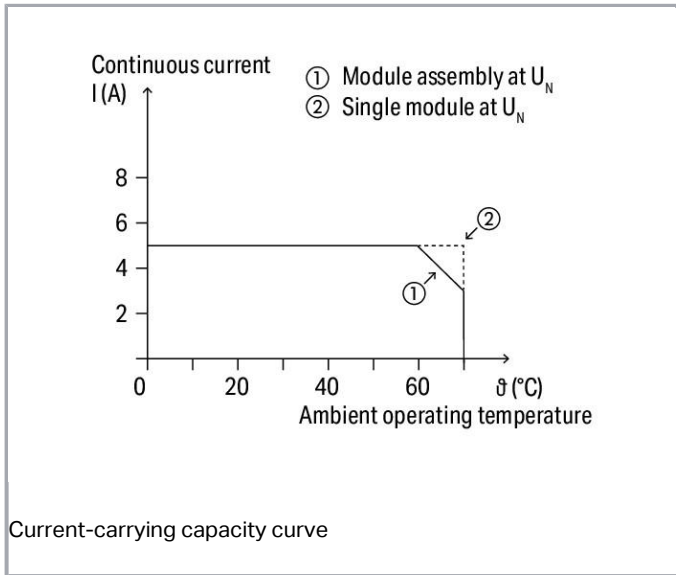

Item description

Note:

Optocouplers and solid state relays are designed for use in signal processing networks, which are not supplied by the low-voltage power supply networks.

Data

Technical Data

Control circuit

Nominal input voltage U_N	DC 24 V
Input voltage range (low level)	DC 0 ... 2,5 V
Input voltage range (high level)	DC 15 ... 30 V
Nominal input current at U_N	9,3 mA

Load circuit:

Circuit type	2-wire connection
Limiting continuous current	5 A
Nominal output voltage	DC 24 V
Output voltage range	DC 0 ... 30 V
Max. voltage drop at output	\leq DC 0,3 V

Subject to changes. Please also observe the further product documentation!



Turn-on time	≤ 50 μs
Drop-out time	≤ 600 μs
Switching frequency	≤ 100 Hz

Signaling

Status indication	Red LED
-------------------	---------

Safety and protection:

Pollution degree	2
Dielectric strength, control/load circuit (AC, 1 min)	2,5 kVrms
Protection class	IP20

Connection data

Connection technology	Push-in CAGE CLAMP®
Solid conductor	0,34 ... 2,5 mm ² / 22 ... 14 AWG
Fine-stranded conductor	0,34 ... 2,5 mm ² / 22 ... 14 AWG
Strip length	9 ... 10 mm / 0.35 ... 0.39 inch

Geometrical Data

Width	15 mm / 0.591 inch
Height from upper-edge of DIN-35 rail	64 mm / 2.52 inch
Depth	86 mm / 3.386 inch

Mechanical data

Type of mounting	DIN-35 rail
------------------	-------------

Material Data

Color	gray
Fire load	0.686 MJ
Weight	47 g

Environmental Requirements

Surrounding air (operating) temperature at U _N	-40 ... 70 °C
Surrounding air (operating) temperature for UL at U _N	-40 ... 40 °C

Subject to changes. Please also observe the further product documentation!

Surrounding air (storage) temperature	-40 ... 70 °C
Processing temperature	-25 ... +50 °C

Standards and specifications

Standards/specifications	EN 61000-6-2; EN 61000-6-3; EN 61373; EN 61010-2-201; UL 508 (max. 40 °C/4.7 A)
--------------------------	---

Commercial data

Product Group	6 (Interface Electronics)
Packaging type	BOX
Country of origin	DE
GTIN	4045454743871
Customs Tariff No.	85365005000

Approvals / Certificates

UL-Approvals

Logo	Approval	Additional Approval Text	Certificate name
	UL UL International Netherlands B.V. (ORDINARY LOCATIONS)	UL 508	E175199 Sec.6











Counterpart

Compatible products













Marking accessories

	Item no.: 2009-110 Marking strips; on reel; not stretchable; plain; snap-on type; white	www.wago.com/2009-110
	Item no.: 2009-115 WMB-Inline; for Smart Printer; 1500 pieces on roll; stretchable 5 - 5.2 mm; plain; snap-on type; white	www.wago.com/2009-115















Subject to changes. Please also observe the further product documentation!

	<p>Item no.: 2009-115/000-002 WMB-Inline; for Smart Printer; 1500 pieces on roll; stretchable 5 - 5.2 mm; plain; snap-on type; yellow</p>	www.wago.com/2009-115/000-002
	<p>Item no.: 2009-115/000-006 WMB-Inline; for Smart Printer; 1500 pieces on roll; stretchable 5 - 5.2 mm; plain; snap-on type; white</p>	www.wago.com/2009-115/000-006
	<p>Item no.: 2009-115/000-007 WMB-Inline; for Smart Printer; 1500 pieces on roll; stretchable 5 - 5.2 mm; plain; snap-on type; gray</p>	www.wago.com/2009-115/000-007
	<p>Item no.: 2009-115/000-012 WMB-Inline; for Smart Printer; 1500 pieces on roll; stretchable 5 - 5.2 mm; plain; snap-on type; white</p>	www.wago.com/2009-115/000-012
	<p>Item no.: 2009-115/000-017 WMB-Inline; for Smart Printer; 1500 pieces on roll; stretchable 5 - 5.2 mm; plain; snap-on type; white</p>	www.wago.com/2009-115/000-017
	<p>Item no.: 2009-115/000-023 WMB-Inline; for Smart Printer; 1500 pieces on roll; stretchable 5 - 5.2 mm; plain; snap-on type; green</p>	www.wago.com/2009-115/000-023
	<p>Item no.: 209-128 Adaptor; gray</p>	www.wago.com/209-128
	<p>Item no.: 209-183 Marker card; white</p>	www.wago.com/209-183
	<p>Item no.: 210-110 Fiber-tip pen</p>	www.wago.com/210-110
	<p>Item no.: 249-105 Group marker carrier; gray</p>	www.wago.com/249-105
	<p>Item no.: 793-501 WMB marking card; as card; not stretchable; plain; snap-on type; white</p>	www.wago.com/793-501
	<p>Item no.: 793-501/000-002 WMB marking card; as card; not stretchable; plain; snap-on type; yellow</p>	www.wago.com/793-501/000-002
	<p>Item no.: 793-501/000-005 WMB marking card; as card; not stretchable; plain; snap-on type; red</p>	www.wago.com/793-501/000-005
	<p>Item no.: 793-501/000-006 WMB marking card; as card; not stretchable; plain; snap-on type; blue</p>	www.wago.com/793-501/000-006
	<p>Item no.: 793-501/000-007 WMB marking card; as card; not stretchable; plain; snap-on type; gray</p>	www.wago.com/793-501/000-007















Subject to changes. Please also observe the further product documentation!

	Item no.: 793-501/000-012 WMB marking card; as card; not stretchable; plain; snap-on type; orange	www.wago.com/793-501/000-012
	Item no.: 793-501/000-017 WMB marking card; as card; not stretchable; plain; snap-on type; light green	www.wago.com/793-501/000-017
	Item no.: 793-501/000-023 WMB marking card; as card; not stretchable; plain; snap-on type; green	www.wago.com/793-501/000-023
	Item no.: 793-501/000-024 WMB marking card; as card; not stretchable; plain; snap-on type; violet	www.wago.com/793-501/000-024
	Item no.: 793-502 WMB marking card; as card; MARKED; 1 ... 10 (10x); not stretchable; Horizontal marking; snap-on type; white	www.wago.com/793-502
	Item no.: 793-502/000-002 WMB marking card; as card; MARKED; 1 ... 10 (10x); not stretchable; Horizontal marking; snap-on type; yellow	www.wago.com/793-502/000-002
	Item no.: 793-502/000-005 WMB marking card; as card; MARKED; 1 ... 10 (10x); not stretchable; Horizontal marking; snap-on type; red	www.wago.com/793-502/000-005
	Item no.: 793-502/000-006 WMB marking card; as card; MARKED; 1 ... 10 (10x); not stretchable; Horizontal marking; snap-on type; blue	www.wago.com/793-502/000-006
	Item no.: 793-502/000-007 WMB marking card; as card; MARKED; 1 ... 10 (10x); not stretchable; Horizontal marking; snap-on type; gray	www.wago.com/793-502/000-007
	Item no.: 793-502/000-012 WMB marking card; as card; MARKED; 1 ... 10 (10x); not stretchable; Horizontal marking; snap-on type; orange	www.wago.com/793-502/000-012
	Item no.: 793-502/000-017 WMB marking card; as card; MARKED; 1 ... 10 (10x); not stretchable; Horizontal marking; snap-on type; light green	www.wago.com/793-502/000-017
	Item no.: 793-502/000-023 WMB marking card; as card; MARKED; 1 ... 10 (10x); not stretchable; Horizontal marking; snap-on type; green	www.wago.com/793-502/000-023
	Item no.: 793-502/000-024 WMB marking card; as card; MARKED; 1 ... 10 (10x); not stretchable; Horizontal marking; snap-on type; violet	www.wago.com/793-502/000-024
	Item no.: 793-503	











Subject to changes. Please also observe the further product documentation!

	WMB marking card; as card; MARKED; 11 ... 20 (10x); not stretchable; Horizontal marking; snap-on type; white	www.wago.com/793-503
	Item no.: 793-503/000-002 WMB marking card; as card; MARKED; 11 ... 20 (10x); not stretchable; Horizontal marking; snap-on type; yellow	www.wago.com/793-503/000-002
	Item no.: 793-503/000-005 WMB marking card; as card; MARKED; 11 ... 20 (10x); not stretchable; Horizontal marking; snap-on type; red	www.wago.com/793-503/000-005
	Item no.: 793-503/000-006 WMB marking card; as card; MARKED; 11 ... 20 (10x); not stretchable; Horizontal marking; snap-on type; blue	www.wago.com/793-503/000-006
	Item no.: 793-503/000-007 WMB marking card; as card; MARKED; 11 ... 20 (10x); not stretchable; Horizontal marking; snap-on type; gray	www.wago.com/793-503/000-007
	Item no.: 793-503/000-012 WMB marking card; as card; MARKED; 11 ... 20 (10x); not stretchable; Horizontal marking; snap-on type; orange	www.wago.com/793-503/000-012
	Item no.: 793-503/000-017 WMB marking card; as card; MARKED; 11 ... 20 (10x); not stretchable; Horizontal marking; snap-on type; light green	www.wago.com/793-503/000-017
	Item no.: 793-503/000-023 WMB marking card; as card; MARKED; 11 ... 20 (10x); not stretchable; Horizontal marking; snap-on type; green	www.wago.com/793-503/000-023
	Item no.: 793-503/000-024 WMB marking card; as card; MARKED; 11 ... 20 (10x); not stretchable; Horizontal marking; snap-on type; violet	www.wago.com/793-503/000-024
	Item no.: 793-504 WMB marking card; as card; MARKED; 21 ... 30 (10x); not stretchable; Horizontal marking; snap-on type; white	www.wago.com/793-504
	Item no.: 793-504/000-002 WMB marking card; as card; MARKED; 21 ... 30 (10x); not stretchable; Horizontal marking; snap-on type; yellow	www.wago.com/793-504/000-002
	Item no.: 793-504/000-005 WMB marking card; as card; MARKED; 21 ... 30 (10x); not stretchable; Horizontal marking; snap-on type; red	www.wago.com/793-504/000-005
	Item no.: 793-504/000-006 WMB marking card; as card; MARKED; 21 ... 30 (10x); not stretchable; Horizontal marking; snap-on type; blue	www.wago.com/793-504/000-006
	Item no.: 793-504/000-012 WMB marking card; as card; MARKED; 21 ... 30 (10x); not stretchable; Horizontal marking; snap-on type; orange	www.wago.com/793-504/000-012

Subject to changes. Please also observe the further product documentation!

	Item no.: 793-504/000-017 WMB marking card; as card; MARKED; 21 ... 30 (10x); not stretchable; Horizontal marking; snap-on type; light green	www.wago.com/793-504/000-017
	Item no.: 793-504/000-023 WMB marking card; as card; MARKED; 21 ... 30 (10x); not stretchable; Horizontal marking; snap-on type; green	www.wago.com/793-504/000-023
	Item no.: 793-505 WMB marking card; as card; MARKED; 31 ... 40 (10x); not stretchable; Horizontal marking; snap-on type; white	www.wago.com/793-505
	Item no.: 793-505/000-005 WMB marking card; as card; MARKED; 31 ... 40 (10x); not stretchable; Horizontal marking; snap-on type; red	www.wago.com/793-505/000-005
	Item no.: 793-505/000-006 WMB marking card; as card; MARKED; 31 ... 40 (10x); not stretchable; Horizontal marking; snap-on type; blue	www.wago.com/793-505/000-006
	Item no.: 793-505/000-007 WMB marking card; as card; MARKED; 31 ... 40 (10x); not stretchable; Horizontal marking; snap-on type; gray	www.wago.com/793-505/000-007
	Item no.: 793-505/000-012 WMB marking card; as card; MARKED; 31 ... 40 (10x); not stretchable; Horizontal marking; snap-on type; orange	www.wago.com/793-505/000-012
	Item no.: 793-506 WMB marking card; as card; MARKED; 41 ... 50 (10x); not stretchable; Horizontal marking; snap-on type; white	www.wago.com/793-506
	Item no.: 793-506/000-005 WMB marking card; as card; MARKED; 41 ... 50 (10x); not stretchable; Horizontal marking; snap-on type; red	www.wago.com/793-506/000-005
	Item no.: 793-506/000-006 WMB marking card; as card; MARKED; 41 ... 50 (10x); not stretchable; Horizontal marking; snap-on type; blue	www.wago.com/793-506/000-006
	Item no.: 793-506/000-012 WMB marking card; as card; MARKED; 41 ... 50 (10x); not stretchable; Horizontal marking; snap-on type; orange	www.wago.com/793-506/000-012
	Item no.: 793-506/000-017 WMB marking card; as card; MARKED; 41 ... 50 (10x); not stretchable; Horizontal marking; snap-on type; light green	www.wago.com/793-506/000-017
	Item no.: 793-5501 WMB marking card; as card; for terminal block width 5 - 17.5 mm; stretchable 5 - 5.2 mm; plain; snap-on type; white	www.wago.com/793-5501
	Item no.: 793-5501/000-002 WMB marking card; as card; for terminal block width 5 - 17.5 mm; stretchable 5 - 5.2 mm; plain; snap-on type; yellow	www.wago.com/793-5501/000-002

Subject to changes. Please also observe the further product documentation!

	Item no.: 793-5501/000-005 WMB marking card; as card; for terminal block width 5 - 17.5 mm; stretchable 5 - 5.2 mm; plain; snap-on type; red	www.wago.com/793-5501/000-005
	Item no.: 793-5501/000-006 WMB marking card; as card; for terminal block width 5 - 17.5 mm; stretchable 5 - 5.2 mm; plain; snap-on type; blue	www.wago.com/793-5501/000-006
	Item no.: 793-5501/000-007 WMB marking card; as card; for terminal block width 5 - 17.5 mm; stretchable 5 - 5.2 mm; plain; snap-on type; gray	www.wago.com/793-5501/000-007
	Item no.: 793-5501/000-012 WMB marking card; as card; for terminal block width 5 - 17.5 mm; stretchable 5 - 5.2 mm; plain; snap-on type; orange	www.wago.com/793-5501/000-012
	Item no.: 793-5501/000-014 WMB marking card; as card; for terminal block width 5 - 17.5 mm; stretchable 5 - 5.2 mm; plain; snap-on type; brown	www.wago.com/793-5501/000-014
	Item no.: 793-5501/000-017 WMB marking card; as card; for terminal block width 5 - 17.5 mm; stretchable 5 - 5.2 mm; plain; snap-on type; green	www.wago.com/793-5501/000-017
	Item no.: 793-5501/000-023 WMB marking card; as card; for terminal block width 5 - 17.5 mm; stretchable 5 - 5.2 mm; plain; snap-on type; light green	www.wago.com/793-5501/000-023
	Item no.: 793-5501/000-024 WMB marking card; as card; for terminal block width 5 - 17.5 mm; stretchable 5 - 5.2 mm; plain; snap-on type; violet	www.wago.com/793-5501/000-024
	Item no.: 793-566 WMB marking card; as card; MARKED; 1 ... 50 (2x); not stretchable; Horizontal marking; snap-on type; white	www.wago.com/793-566
	Item no.: 793-566/000-002 WMB marking card; as card; MARKED; 1 ... 50 (2x); not stretchable; Horizontal marking; snap-on type; yellow	www.wago.com/793-566/000-002
	Item no.: 793-566/000-005 WMB marking card; as card; MARKED; 1 ... 50 (2x); not stretchable; Horizontal marking; snap-on type; red	www.wago.com/793-566/000-005
	Item no.: 793-566/000-006 WMB marking card; as card; MARKED; 1 ... 50 (2x); not stretchable; Horizontal marking; snap-on type; blue	www.wago.com/793-566/000-006
	Item no.: 793-566/000-007 WMB marking card; as card; MARKED; 1 ... 50 (2x); not stretchable; Horizontal marking; snap-on type; gray	www.wago.com/793-566/000-007
	Item no.: 793-566/000-012	

Subject to changes. Please also observe the further product documentation!



WMB marking card; as card; MARKED; 1 ... 50 (2x); not stretchable; Horizontal marking; snap-on type; orange

www.wago.com/793-566/000-012



Item no.: 793-566/000-017

WMB marking card; as card; MARKED; 1 ... 50 (2x); not stretchable; Horizontal marking; snap-on type; light green

www.wago.com/793-566/000-017



Item no.: 793-566/000-023

WMB marking card; as card; MARKED; 1 ... 50 (2x); not stretchable; Horizontal marking; snap-on type; green

www.wago.com/793-566/000-023



Item no.: 793-566/000-024

WMB marking card; as card; MARKED; 1 ... 50 (2x); not stretchable; Horizontal marking; snap-on type; violet

www.wago.com/793-566/000-024

General accessories

Item no.: 209-145

Group marker carrier; white

www.wago.com/209-145

Item no.: 209-184

Protection cover; transparent

www.wago.com/209-184

Item no.: 788-120

Accessories for relay modules; Operation status indicator: red

www.wago.com/788-120

ferrule

Item no.: 216-241

Ferrule; Sleeve for 0.5 mm² / 20 AWG; insulated; electro-tin plated; electrolytic copper; gastight crimped; acc. to DIN 46228, Part 4/09.90; white

www.wago.com/216-241



Item no.: 216-242

Ferrule; Sleeve for 0.75 mm² / 18 AWG; insulated; electro-tin plated; electrolytic copper; gastight crimped; acc. to DIN 46228, Part 4/09.90; gray

www.wago.com/216-242



Item no.: 216-243

Ferrule; Sleeve for 1 mm² / AWG 18; insulated; electro-tin plated; electrolytic copper; gastight crimped; acc. to DIN 46228, Part 4/09.90; red

www.wago.com/216-243

Item no.: 216-244

Ferrule; Sleeve for 1.5 mm² / AWG 16; insulated; electro-tin plated; electrolytic copper; gastight crimped; acc. to DIN 46228, Part 4/09.90; black

www.wago.com/216-244



Item no.: 216-542

Twin ferrule; Sleeve for 2 x 1 mm² / AWG 2 x 18; red, insulated; 12 mm long; red

www.wago.com/216-542

tools



Item no.: 210-720

Operating tool; Blade: 3.5 x 0.5 mm; with a partially insulated shaft

www.wago.com/210-720

Jumper



Item no.: 788-113

Comb-style jumper bar; 2-way; insulated

www.wago.com/788-113

Subject to changes. Please also observe the further product documentation!

WAGO Kontakttechnik GmbH & Co. KG

Hansastr. 27





32423 Minden

Phone: +49571 887-0 | Fax: +49571 887-169

Email: info.de@wago.com | Web: www.wago.com

Do you have any questions about our products?

We are always happy to take your call at +49 (571) 887-44222.

	Item no.: 788-114 Comb-style jumper bar; 3-way; insulated	www.wago.com/788-114
	Item no.: 788-115 Comb-style jumper bar; 4-way; insulated	www.wago.com/788-115
	Item no.: 788-116 Comb-style jumper bar; 6-way; insulated	www.wago.com/788-116
	Item no.: 788-117 Comb-style jumper bar; 8-way; insulated	www.wago.com/788-117
	Item no.: 788-118 Comb-style jumper bar; 2-way (1-3); insulated	www.wago.com/788-118
	Item no.: 859-402 Push-in type jumper bar; 2-way; Nominal current 18 A; insulated; light gray	www.wago.com/859-402
	Item no.: 859-402/000-005 Push-in type jumper bar; 2-way; Nominal current 18 A; insulated; red	www.wago.com/859-402/000-005
	Item no.: 859-402/000-006 Push-in type jumper bar; 2-way; Nominal current 18 A; insulated; blue	www.wago.com/859-402/000-006
	Item no.: 859-402/000-029 Push-in type jumper bar; 2-way; Nominal current 18 A; insulated; yellow	www.wago.com/859-402/000-029

Downloads

Documentation

Instruction Leaflet

Sockets with Elementary Relay/ SSR	V 1.0.0	pdf 2.4 MB	Download
------------------------------------	---------	---------------	----------

Additional Information

Disposal; Electrical and electronic equipment, Packaging	V 1.0.0	pdf 265.8 kB	Download
--	---------	-----------------	----------

CAD/CAE-Data

CAD data

2D/3D Models 788-701	URL	Download
----------------------	-----	----------

Subject to changes. Please also observe the further product documentation!

CAE data

EPLAN Data Portal 788-701

URL

Download

WSCAD Universe 788-701

URL

Download

Installation Notes

Conductor termination

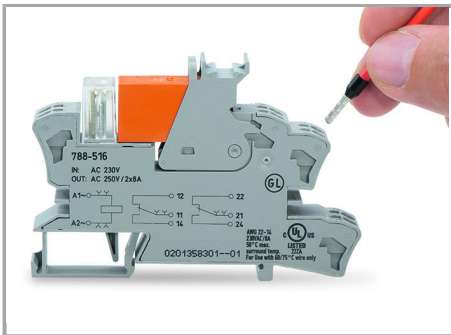

Leiter anschließen

Commoning

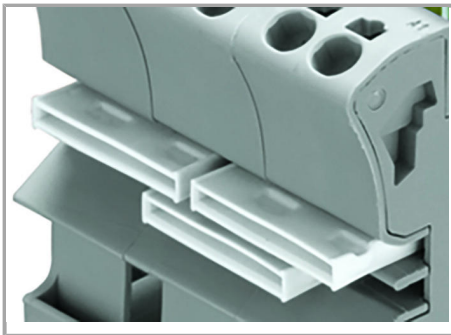

Easy commoning using adjacent jumpers

Marking

Subject to changes. Please also observe the further product documentation!

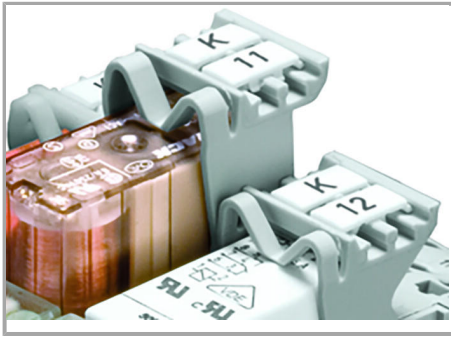

Marking using WMB Multi markers and group marker carriers

Subject to changes. Please also observe the further product documentation!