

**Data sheet | Item number: 788-391**

Relay module; Nominal input voltage: 24 VDC; 1 changeover contact;  
Limiting continuous current: 16 A; with manual operation; Path; Red status  
indicator; Module width: 15 mm

[www.wago.com/788-391](http://www.wago.com/788-391)

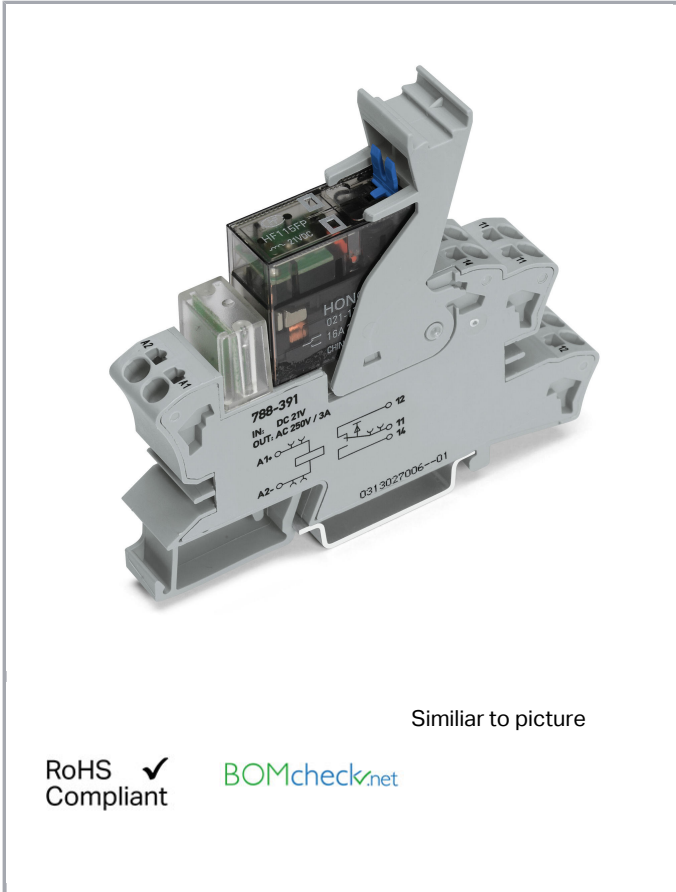

Similar to picture

RoHS  
Compliant

BOMcheck.net

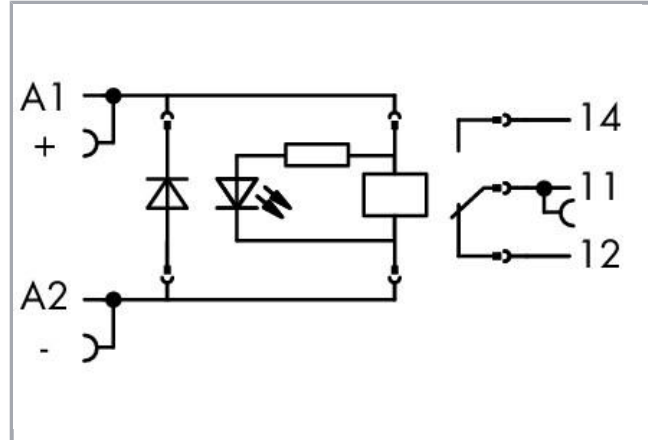

Subject to changes. Please also observe the further product documentation!

WAGO Kontakttechnik GmbH & Co. KG  
Hansastr. 27  
32423 Minden  
Phone: +49571 887-0 | Fax: +49571 887-169  
Email: [info.de@wago.com](mailto:info.de@wago.com) | Web: [www.wago.com](http://www.wago.com)

Do you have any questions about our products?  
We are always happy to take your call at +49 (571) 887-44222.

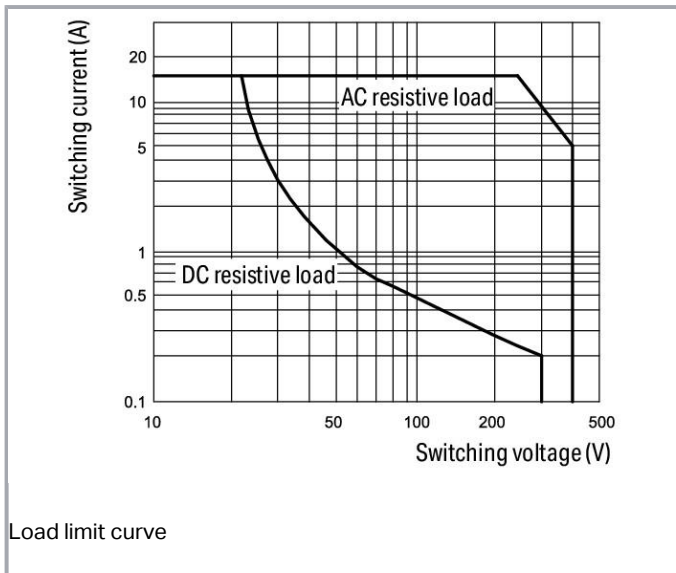
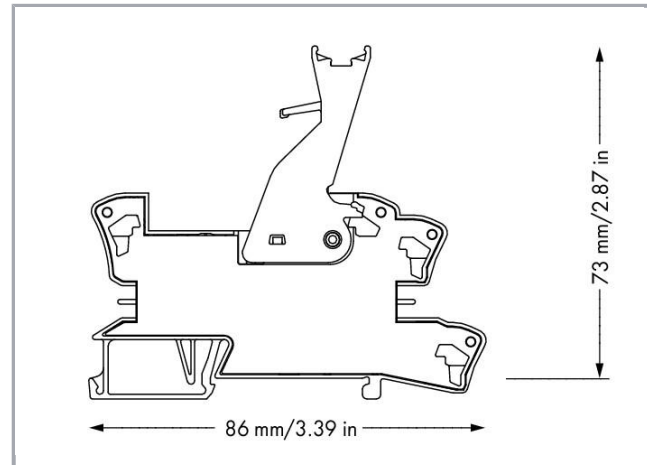
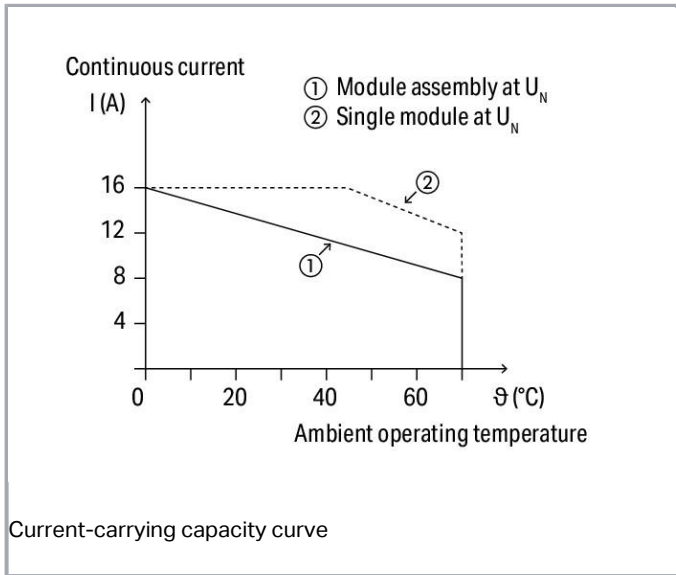

## Item description

### Note:

- Reinforced insulation between coil and contacts
- A separator plate (e.g., 209-191) must be used for voltages greater than 250 V between adjacent relay modules and for compliance with the reinforced insulation requirements.
- To protect the relay coils and contacts, inductive loads must be dampened with an effective protection circuit.

Subject to changes. Please also observe the further product documentation!

**Data****Technical Data****Control circuit**

Nominal input voltage $U_N$	DC 24 V
Input voltage range	-30 ... +25 %
Nominal input current at $U_N$	19.1 mA

**Load circuit:**

Number of changeover/switchover contacts	1
Contact material (relay)	AgNi
Limiting continuous current	16 A
Max. make current (resistive)	(AC) 32 A / 0.02 s; (AC) 24 A / 4 s
Max. switching voltage	AC 250 V
Max. switching power (resistive)	AC 4000 VA; DC see load limit curve
Switching capacity	AC-15: 3 A / AC 240 V; DC-13: 2 A / DC 24 V
Recommended minimum load	12 V / 10 mA
Pull-in time (typ.)	15 ms
Drop-out time (typ.)	8 ms
Bounce time (typ.)	6 ms
Electrical life (N.O.; resistive load; 23 °C)	$10 \times 10^3$ switching operations
Mechanical life	$5 \times 10^6$ switching operations
Max. switching load with load/without load	$6 \text{ min}^{-1} / 300 \text{ min}^{-1}$

**Signaling**

Status indication	LED red
-------------------	---------

**Safety and protection:**

Rated voltage	250 V
Rated impulse voltage	4 kV
Pollution degree	3
Dielectric strength, control/load circuit (AC, 1 min)	5 kVrms
Dielectric strength open contact (AC, 1 min)	1 kVrms
Protection class	IP20

Subject to changes. Please also observe the further product documentation!

## Connection data

Connection technology	Push-in CAGE CLAMP®
Solid conductor	0.34 ... 2.5 mm <sup>2</sup> / 22 ... 14 AWG
Fine-stranded conductor	0.34 ... 2.5 mm <sup>2</sup> / 22 ... 14 AWG
Strip length	9 ... 10 mm / 0.35 ... 0.39 inch

## Geometrical Data

Width	15 mm / 0.591 inch
Height from upper-edge of DIN-35 rail	73 mm / 2.874 inch
Depth	86 mm / 3.386 inch

## Mechanical data

Type of mounting	DIN-35 rail
------------------	-------------

## Material Data

Fire load	0.662 MJ
Weight	45 g

## Environmental Requirements

Surrounding air (operating) temperature at U <sub>N</sub>	-40 ... 70 °C
Surrounding air (storage) temperature	-40 ... 70 °C
Processing temperature	-25 ... +50 °C

## Standards and specifications

Standards/specifications	EN 61010-2-201; EN 61810-1; EN 61373
--------------------------	--------------------------------------

## Commercial data

Product Group	6 (Interface Electronics)
Packaging type	BOX
Country of origin	DE
GTIN	4050821128731
Customs Tariff No.	85364900990

## Counterpart









Subject to changes. Please also observe the further product documentation!

WAGO Kontakttechnik GmbH & Co. KG  
 Hansastr. 27  
 32423 Minden  
 Phone: +49571 887-0 | Fax: +49571 887-169  
 Email: [info.de@wago.com](mailto:info.de@wago.com) | Web: [www.wago.com](http://www.wago.com)

Do you have any questions about our products?  
 We are always happy to take your call at +49 (571) 887-44222.

## Compatible products

### Jumper

	<b>Item no.: 788-113</b> Comb-style jumper bar; 2-way; insulated	<a href="http://www.wago.com/788-113">www.wago.com/788-113</a>
	<b>Item no.: 788-114</b> Comb-style jumper bar; 3-way; insulated	<a href="http://www.wago.com/788-114">www.wago.com/788-114</a>
	<b>Item no.: 788-115</b> Comb-style jumper bar; 4-way; insulated	<a href="http://www.wago.com/788-115">www.wago.com/788-115</a>
	<b>Item no.: 788-116</b> Comb-style jumper bar; 6-way; insulated	<a href="http://www.wago.com/788-116">www.wago.com/788-116</a>
	<b>Item no.: 788-117</b> Comb-style jumper bar; 8-way; insulated	<a href="http://www.wago.com/788-117">www.wago.com/788-117</a>
	<b>Item no.: 788-118</b> Comb-style jumper bar; 2-way (1-3); insulated	<a href="http://www.wago.com/788-118">www.wago.com/788-118</a>
	<b>Item no.: 859-402</b> Push-in type jumper bar; 2-way; Nominal current 18 A; insulated; light gray	<a href="http://www.wago.com/859-402">www.wago.com/859-402</a>
	<b>Item no.: 859-402/000-005</b> Push-in type jumper bar; 2-way; Nominal current 18 A; insulated; red	<a href="http://www.wago.com/859-402/000-005">www.wago.com/859-402/000-005</a>
	<b>Item no.: 859-402/000-006</b> Push-in type jumper bar; 2-way; Nominal current 18 A; insulated; blue	<a href="http://www.wago.com/859-402/000-006">www.wago.com/859-402/000-006</a>
	<b>Item no.: 859-402/000-029</b> Push-in type jumper bar; 2-way; Nominal current 18 A; insulated; yellow	<a href="http://www.wago.com/859-402/000-029">www.wago.com/859-402/000-029</a>

### tools

	<b>Item no.: 210-720</b> Operating tool; Blade: 3.5 x 0.5 mm; with a partially insulated shaft	<a href="http://www.wago.com/210-720">www.wago.com/210-720</a>
------------------------------------------------------------------------------------	---------------------------------------------------------------------------------------------------	----------------------------------------------------------------

### General accessories

	<b>Item no.: 209-145</b> Group marker carrier; white	<a href="http://www.wago.com/209-145">www.wago.com/209-145</a>
	<b>Item no.: 209-184</b> Protection cover; transparent	<a href="http://www.wago.com/209-184">www.wago.com/209-184</a>

Subject to changes. Please also observe the further product documentation!

Item no.: 788-120

Accessories for relay modules; Operation status indicator: red

[www.wago.com/788-120](http://www.wago.com/788-120)

---

**Marking accessories**

Item no.: 2009-110

Marking strips; on reel; not stretchable; plain; snap-on type; white

[www.wago.com/2009-110](http://www.wago.com/2009-110)

Item no.: 2009-115

WMB-Inline; for Smart Printer; 1500 pieces on roll; stretchable 5 - 5.2 mm; plain; snap-on type; white

[www.wago.com/2009-115](http://www.wago.com/2009-115)

Item no.: 2009-115/000-002

WMB-Inline; for Smart Printer; 1500 pieces on roll; stretchable 5 - 5.2 mm; plain; snap-on type; yellow

[www.wago.com/2009-115/000-002](http://www.wago.com/2009-115/000-002)

Item no.: 2009-115/000-006

WMB-Inline; for Smart Printer; 1500 pieces on roll; stretchable 5 - 5.2 mm; plain; snap-on type; white

[www.wago.com/2009-115/000-006](http://www.wago.com/2009-115/000-006)

Item no.: 2009-115/000-007

WMB-Inline; for Smart Printer; 1500 pieces on roll; stretchable 5 - 5.2 mm; plain; snap-on type; gray

[www.wago.com/2009-115/000-007](http://www.wago.com/2009-115/000-007)

Item no.: 2009-115/000-012

WMB-Inline; for Smart Printer; 1500 pieces on roll; stretchable 5 - 5.2 mm; plain; snap-on type; white

[www.wago.com/2009-115/000-012](http://www.wago.com/2009-115/000-012)

Item no.: 2009-115/000-017

WMB-Inline; for Smart Printer; 1500 pieces on roll; stretchable 5 - 5.2 mm; plain; snap-on type; white

[www.wago.com/2009-115/000-017](http://www.wago.com/2009-115/000-017)

Item no.: 2009-115/000-023

WMB-Inline; for Smart Printer; 1500 pieces on roll; stretchable 5 - 5.2 mm; plain; snap-on type; green

[www.wago.com/2009-115/000-023](http://www.wago.com/2009-115/000-023)

Item no.: 209-128

Adaptor; gray

[www.wago.com/209-128](http://www.wago.com/209-128)

Item no.: 209-183

Marker card; white

[www.wago.com/209-183](http://www.wago.com/209-183)

Item no.: 210-110

Fiber-tip pen

[www.wago.com/210-110](http://www.wago.com/210-110)

Item no.: 249-105

Group marker carrier; gray

[www.wago.com/249-105](http://www.wago.com/249-105)

Item no.: 793-501

WMB marking card; as card; not stretchable; plain; snap-on type; white

[www.wago.com/793-501](http://www.wago.com/793-501)

Item no.: 793-501/000-002

WMB marking card; as card; not stretchable; plain; snap-on type; yellow

[www.wago.com/793-501/000-002](http://www.wago.com/793-501/000-002)

---

 Subject to changes. Please also observe the further product documentation!

WAGO Kontakttechnik GmbH &amp; Co. KG

Hansastr. 27







32423 Minden

Phone: +49571 887-0 | Fax: +49571 887-169

Email: [info.de@wago.com](mailto:info.de@wago.com) | Web: [www.wago.com](http://www.wago.com)

Do you have any questions about our products?

We are always happy to take your call at +49 (571) 887-44222.

	<p><b>Item no.: 793-501/000-005</b> WMB marking card; as card; not stretchable; plain; snap-on type; red</p>	<p><a href="http://www.wago.com/793-501/000-005">www.wago.com/793-501/000-005</a></p>
	<p><b>Item no.: 793-501/000-006</b> WMB marking card; as card; not stretchable; plain; snap-on type; blue</p>	<p><a href="http://www.wago.com/793-501/000-006">www.wago.com/793-501/000-006</a></p>
	<p><b>Item no.: 793-501/000-007</b> WMB marking card; as card; not stretchable; plain; snap-on type; gray</p>	<p><a href="http://www.wago.com/793-501/000-007">www.wago.com/793-501/000-007</a></p>
	<p><b>Item no.: 793-501/000-012</b> WMB marking card; as card; not stretchable; plain; snap-on type; orange</p>	<p><a href="http://www.wago.com/793-501/000-012">www.wago.com/793-501/000-012</a></p>
	<p><b>Item no.: 793-501/000-017</b> WMB marking card; as card; not stretchable; plain; snap-on type; light green</p>	<p><a href="http://www.wago.com/793-501/000-017">www.wago.com/793-501/000-017</a></p>
	<p><b>Item no.: 793-501/000-023</b> WMB marking card; as card; not stretchable; plain; snap-on type; green</p>	<p><a href="http://www.wago.com/793-501/000-023">www.wago.com/793-501/000-023</a></p>
	<p><b>Item no.: 793-501/000-024</b> WMB marking card; as card; not stretchable; plain; snap-on type; violet</p>	<p><a href="http://www.wago.com/793-501/000-024">www.wago.com/793-501/000-024</a></p>
	<p><b>Item no.: 793-502</b> WMB marking card; as card; MARKED; 1 ... 10 (10x); not stretchable; Horizontal marking; snap-on type; white</p>	<p><a href="http://www.wago.com/793-502">www.wago.com/793-502</a></p>
	<p><b>Item no.: 793-502/000-002</b> WMB marking card; as card; MARKED; 1 ... 10 (10x); not stretchable; Horizontal marking; snap-on type; yellow</p>	<p><a href="http://www.wago.com/793-502/000-002">www.wago.com/793-502/000-002</a></p>
	<p><b>Item no.: 793-502/000-005</b> WMB marking card; as card; MARKED; 1 ... 10 (10x); not stretchable; Horizontal marking; snap-on type; red</p>	<p><a href="http://www.wago.com/793-502/000-005">www.wago.com/793-502/000-005</a></p>
	<p><b>Item no.: 793-502/000-006</b> WMB marking card; as card; MARKED; 1 ... 10 (10x); not stretchable; Horizontal marking; snap-on type; blue</p>	<p><a href="http://www.wago.com/793-502/000-006">www.wago.com/793-502/000-006</a></p>
	<p><b>Item no.: 793-502/000-007</b> WMB marking card; as card; MARKED; 1 ... 10 (10x); not stretchable; Horizontal marking; snap-on type; gray</p>	<p><a href="http://www.wago.com/793-502/000-007">www.wago.com/793-502/000-007</a></p>
	<p><b>Item no.: 793-502/000-012</b> WMB marking card; as card; MARKED; 1 ... 10 (10x); not stretchable; Horizontal marking; snap-on type; orange</p>	<p><a href="http://www.wago.com/793-502/000-012">www.wago.com/793-502/000-012</a></p>
	<p><b>Item no.: 793-502/000-017</b> WMB marking card; as card; MARKED; 1 ... 10 (10x); not stretchable; Horizontal marking; snap-on type;</p>	<p><a href="http://www.wago.com/793-502/000-017">www.wago.com/793-502/000-017</a></p>

Subject to changes. Please also observe the further product documentation!

light green

**Item no.: 793-502/000-023**

WMB marking card; as card; MARKED; 1 ... 10 (10x); not stretchable; Horizontal marking; snap-on type; green

[www.wago.com/793-502/000-023](http://www.wago.com/793-502/000-023)**Item no.: 793-502/000-024**

WMB marking card; as card; MARKED; 1 ... 10 (10x); not stretchable; Horizontal marking; snap-on type; violet

[www.wago.com/793-502/000-024](http://www.wago.com/793-502/000-024)**Item no.: 793-503**WMB marking card; as card; MARKED; 11 ... 20 (10x); not stretchable; Horizontal marking; snap-on type; white [www.wago.com/793-503](http://www.wago.com/793-503)**Item no.: 793-503/000-002**

WMB marking card; as card; MARKED; 11 ... 20 (10x); not stretchable; Horizontal marking; snap-on type; yellow

[www.wago.com/793-503/000-002](http://www.wago.com/793-503/000-002)**Item no.: 793-503/000-005**

WMB marking card; as card; MARKED; 11 ... 20 (10x); not stretchable; Horizontal marking; snap-on type; red

[www.wago.com/793-503/000-005](http://www.wago.com/793-503/000-005)**Item no.: 793-503/000-006**

WMB marking card; as card; MARKED; 11 ... 20 (10x); not stretchable; Horizontal marking; snap-on type; blue

[www.wago.com/793-503/000-006](http://www.wago.com/793-503/000-006)**Item no.: 793-503/000-007**

WMB marking card; as card; MARKED; 11 ... 20 (10x); not stretchable; Horizontal marking; snap-on type; gray

[www.wago.com/793-503/000-007](http://www.wago.com/793-503/000-007)**Item no.: 793-503/000-012**

WMB marking card; as card; MARKED; 11 ... 20 (10x); not stretchable; Horizontal marking; snap-on type; orange

[www.wago.com/793-503/000-012](http://www.wago.com/793-503/000-012)**Item no.: 793-503/000-017**

WMB marking card; as card; MARKED; 11 ... 20 (10x); not stretchable; Horizontal marking; snap-on type; light green

[www.wago.com/793-503/000-017](http://www.wago.com/793-503/000-017)**Item no.: 793-503/000-023**

WMB marking card; as card; MARKED; 11 ... 20 (10x); not stretchable; Horizontal marking; snap-on type; green

[www.wago.com/793-503/000-023](http://www.wago.com/793-503/000-023)**Item no.: 793-503/000-024**

WMB marking card; as card; MARKED; 11 ... 20 (10x); not stretchable; Horizontal marking; snap-on type; violet

[www.wago.com/793-503/000-024](http://www.wago.com/793-503/000-024)**Item no.: 793-504**WMB marking card; as card; MARKED; 21 ... 30 (10x); not stretchable; Horizontal marking; snap-on type; white [www.wago.com/793-504](http://www.wago.com/793-504)**Item no.: 793-504/000-002**

WMB marking card; as card; MARKED; 21 ... 30 (10x); not stretchable; Horizontal marking; snap-on type; yellow

[www.wago.com/793-504/000-002](http://www.wago.com/793-504/000-002)**Item no.: 793-504/000-005**

Subject to changes. Please also observe the further product documentation!

WAGO Kontakttechnik GmbH &amp; Co. KG

Hansastr. 27

32423 Minden

Phone: +49571 887-0 | Fax: +49571 887-169

Email: [info.de@wago.com](mailto:info.de@wago.com) | Web: [www.wago.com](http://www.wago.com)

Do you have any questions about our products?

We are always happy to take your call at +49 (571) 887-44222.





WMB marking card; as card; MARKED; 21 ... 30 (10x); not stretchable; Horizontal marking; snap-on type; [www.wago.com/793-504/000-005](http://www.wago.com/793-504/000-005)  
red



**Item no.: 793-504/000-006**  
WMB marking card; as card; MARKED; 21 ... 30 (10x); not stretchable; Horizontal marking; snap-on type; [www.wago.com/793-504/000-006](http://www.wago.com/793-504/000-006)  
blue

**Item no.: 793-504/000-012**  
WMB marking card; as card; MARKED; 21 ... 30 (10x); not stretchable; Horizontal marking; snap-on type; [www.wago.com/793-504/000-012](http://www.wago.com/793-504/000-012)  
orange

**Item no.: 793-504/000-017**  
WMB marking card; as card; MARKED; 21 ... 30 (10x); not stretchable; Horizontal marking; snap-on type; [www.wago.com/793-504/000-017](http://www.wago.com/793-504/000-017)  
light green



**Item no.: 793-504/000-023**  
WMB marking card; as card; MARKED; 21 ... 30 (10x); not stretchable; Horizontal marking; snap-on type; [www.wago.com/793-504/000-023](http://www.wago.com/793-504/000-023)  
green

**Item no.: 793-505**  
WMB marking card; as card; MARKED; 31 ... 40 (10x); not stretchable; Horizontal marking; snap-on type; [www.wago.com/793-505](http://www.wago.com/793-505)  
white

**Item no.: 793-505/000-005**  
WMB marking card; as card; MARKED; 31 ... 40 (10x); not stretchable; Horizontal marking; snap-on type; [www.wago.com/793-505/000-005](http://www.wago.com/793-505/000-005)  
red



**Item no.: 793-505/000-006**  
WMB marking card; as card; MARKED; 31 ... 40 (10x); not stretchable; Horizontal marking; snap-on type; [www.wago.com/793-505/000-006](http://www.wago.com/793-505/000-006)  
blue



**Item no.: 793-505/000-007**  
WMB marking card; as card; MARKED; 31 ... 40 (10x); not stretchable; Horizontal marking; snap-on type; [www.wago.com/793-505/000-007](http://www.wago.com/793-505/000-007)  
gray



**Item no.: 793-505/000-012**  
WMB marking card; as card; MARKED; 31 ... 40 (10x); not stretchable; Horizontal marking; snap-on type; [www.wago.com/793-505/000-012](http://www.wago.com/793-505/000-012)  
orange



**Item no.: 793-506**  
WMB marking card; as card; MARKED; 41 ... 50 (10x); not stretchable; Horizontal marking; snap-on type; [www.wago.com/793-506](http://www.wago.com/793-506)  
white



**Item no.: 793-506/000-005**  
WMB marking card; as card; MARKED; 41 ... 50 (10x); not stretchable; Horizontal marking; snap-on type; [www.wago.com/793-506/000-005](http://www.wago.com/793-506/000-005)  
red















**Item no.: 793-506/000-006**  
WMB marking card; as card; MARKED; 41 ... 50 (10x); not stretchable; Horizontal marking; snap-on type; [www.wago.com/793-506/000-006](http://www.wago.com/793-506/000-006)  
blue













**Item no.: 793-506/000-012**  
WMB marking card; as card; MARKED; 41 ... 50 (10x); not stretchable; Horizontal marking; snap-on type; [www.wago.com/793-506/000-012](http://www.wago.com/793-506/000-012)  
orange

Subject to changes. Please also observe the further product documentation!

	<p><b>Item no.: 793-506/000-017</b>                  WMB marking card; as card; MARKED; 41 ... 50 (10x); not stretchable; Horizontal marking; snap-on type; light green</p>	<a href="http://www.wago.com/793-506/000-017">www.wago.com/793-506/000-017</a>
	<p><b>Item no.: 793-5501</b>                  WMB marking card; as card; for terminal block width 5 - 17.5 mm; stretchable 5 - 5.2 mm; plain; snap-on type; white</p>	<a href="http://www.wago.com/793-5501">www.wago.com/793-5501</a>
	<p><b>Item no.: 793-5501/000-002</b>                  WMB marking card; as card; for terminal block width 5 - 17.5 mm; stretchable 5 - 5.2 mm; plain; snap-on type; yellow</p>	<a href="http://www.wago.com/793-5501/000-002">www.wago.com/793-5501/000-002</a>
	<p><b>Item no.: 793-5501/000-005</b>                  WMB marking card; as card; for terminal block width 5 - 17.5 mm; stretchable 5 - 5.2 mm; plain; snap-on type; red</p>	<a href="http://www.wago.com/793-5501/000-005">www.wago.com/793-5501/000-005</a>
	<p><b>Item no.: 793-5501/000-006</b>                  WMB marking card; as card; for terminal block width 5 - 17.5 mm; stretchable 5 - 5.2 mm; plain; snap-on type; blue</p>	<a href="http://www.wago.com/793-5501/000-006">www.wago.com/793-5501/000-006</a>
	<p><b>Item no.: 793-5501/000-007</b>                  WMB marking card; as card; for terminal block width 5 - 17.5 mm; stretchable 5 - 5.2 mm; plain; snap-on type; gray</p>	<a href="http://www.wago.com/793-5501/000-007">www.wago.com/793-5501/000-007</a>
	<p><b>Item no.: 793-5501/000-012</b>                  WMB marking card; as card; for terminal block width 5 - 17.5 mm; stretchable 5 - 5.2 mm; plain; snap-on type; orange</p>	<a href="http://www.wago.com/793-5501/000-012">www.wago.com/793-5501/000-012</a>
	<p><b>Item no.: 793-5501/000-014</b>                  WMB marking card; as card; for terminal block width 5 - 17.5 mm; stretchable 5 - 5.2 mm; plain; snap-on type; brown</p>	<a href="http://www.wago.com/793-5501/000-014">www.wago.com/793-5501/000-014</a>
	<p><b>Item no.: 793-5501/000-017</b>                  WMB marking card; as card; for terminal block width 5 - 17.5 mm; stretchable 5 - 5.2 mm; plain; snap-on type; green</p>	<a href="http://www.wago.com/793-5501/000-017">www.wago.com/793-5501/000-017</a>
	<p><b>Item no.: 793-5501/000-023</b>                  WMB marking card; as card; for terminal block width 5 - 17.5 mm; stretchable 5 - 5.2 mm; plain; snap-on type; light green</p>	<a href="http://www.wago.com/793-5501/000-023">www.wago.com/793-5501/000-023</a>
	<p><b>Item no.: 793-5501/000-024</b>                  WMB marking card; as card; for terminal block width 5 - 17.5 mm; stretchable 5 - 5.2 mm; plain; snap-on type; violet</p>	<a href="http://www.wago.com/793-5501/000-024">www.wago.com/793-5501/000-024</a>
	<p><b>Item no.: 793-566</b>                  WMB marking card; as card; MARKED; 1 ... 50 (2x); not stretchable; Horizontal marking; snap-on type; white</p>	<a href="http://www.wago.com/793-566">www.wago.com/793-566</a>
	<p><b>Item no.: 793-566/000-002</b>                  WMB marking card; as card; MARKED; 1 ... 50 (2x); not stretchable; Horizontal marking; snap-on type; yellow</p>	<a href="http://www.wago.com/793-566/000-002">www.wago.com/793-566/000-002</a>
	<p><b>Item no.: 793-566/000-005</b>                  WMB marking card; as card; MARKED; 1 ... 50 (2x); not stretchable; Horizontal marking; snap-on type;</p>	

Subject to changes. Please also observe the further product documentation!

	red	<a href="http://www.wago.com/793-566/000-005">www.wago.com/793-566/000-005</a>
	<b>Item no.: 793-566/000-006</b> WMB marking card; as card; MARKED; 1 ... 50 (2x); not stretchable; Horizontal marking; snap-on type; blue	<a href="http://www.wago.com/793-566/000-006">www.wago.com/793-566/000-006</a>
	<b>Item no.: 793-566/000-007</b> WMB marking card; as card; MARKED; 1 ... 50 (2x); not stretchable; Horizontal marking; snap-on type; gray	<a href="http://www.wago.com/793-566/000-007">www.wago.com/793-566/000-007</a>
	<b>Item no.: 793-566/000-012</b> WMB marking card; as card; MARKED; 1 ... 50 (2x); not stretchable; Horizontal marking; snap-on type; orange	<a href="http://www.wago.com/793-566/000-012">www.wago.com/793-566/000-012</a>
	<b>Item no.: 793-566/000-017</b> WMB marking card; as card; MARKED; 1 ... 50 (2x); not stretchable; Horizontal marking; snap-on type; light green	<a href="http://www.wago.com/793-566/000-017">www.wago.com/793-566/000-017</a>
	<b>Item no.: 793-566/000-023</b> WMB marking card; as card; MARKED; 1 ... 50 (2x); not stretchable; Horizontal marking; snap-on type; green	<a href="http://www.wago.com/793-566/000-023">www.wago.com/793-566/000-023</a>
	<b>Item no.: 793-566/000-024</b> WMB marking card; as card; MARKED; 1 ... 50 (2x); not stretchable; Horizontal marking; snap-on type; violet	<a href="http://www.wago.com/793-566/000-024">www.wago.com/793-566/000-024</a>
<b>ferrule</b>		
	<b>Item no.: 216-241</b> Ferrule; Sleeve for 0.5 mm <sup>2</sup> / 20 AWG; insulated; electro-tin plated; electrolytic copper; gastight crimped; acc. to DIN 46228, Part 4/09.90; white	<a href="http://www.wago.com/216-241">www.wago.com/216-241</a>
	<b>Item no.: 216-242</b> Ferrule; Sleeve for 0.75 mm <sup>2</sup> / 18 AWG; insulated; electro-tin plated; electrolytic copper; gastight crimped; acc. to DIN 46228, Part 4/09.90; gray	<a href="http://www.wago.com/216-242">www.wago.com/216-242</a>
	<b>Item no.: 216-243</b> Ferrule; Sleeve for 1 mm <sup>2</sup> / AWG 18; insulated; electro-tin plated; electrolytic copper; gastight crimped; acc. to DIN 46228, Part 4/09.90; red	<a href="http://www.wago.com/216-243">www.wago.com/216-243</a>
	<b>Item no.: 216-244</b> Ferrule; Sleeve for 1.5 mm <sup>2</sup> / AWG 16; insulated; electro-tin plated; electrolytic copper; gastight crimped; acc. to DIN 46228, Part 4/09.90; black	<a href="http://www.wago.com/216-244">www.wago.com/216-244</a>
	<b>Item no.: 216-542</b> Twin ferrule; Sleeve for 2 x 1 mm <sup>2</sup> / AWG 2 x 18; red, insulated; 12 mm long; red	<a href="http://www.wago.com/216-542">www.wago.com/216-542</a>

## Downloads

### Documentation

#### Instruction Leaflet

Sockets with Elementary Relay/ SSR

Subject to changes. Please also observe the further product documentation!

WAGO Kontakttechnik GmbH & Co. KG

Hansastr. 27

32423 Minden

Phone: +49571 887-0 | Fax: +49571 887-169

Email: [info.de@wago.com](mailto:info.de@wago.com) | Web: [www.wago.com](http://www.wago.com)

Do you have any questions about our products?

We are always happy to take your call at +49 (571) 887-44222.

V 1.0.0

pdf  
2.4 MB

Download

### Additional Information

Disposal; Electrical and electronic equipment, Packaging

V 1.0.0

pdf  
265.8 kB

Download

### CAD/CAE-Data

#### CAD data

2D/3D Models 788-391

URL

Download

#### CAE data

EPLAN Data Portal 788-391

URL

Download

WSCAD Universe 788-391

URL

Download

### Installation Notes

#### Conductor termination

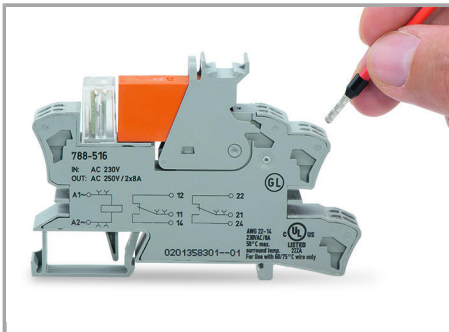

Leiter anschließen

#### Commoning

Subject to changes. Please also observe the further product documentation!

WAGO Kontakttechnik GmbH & Co. KG

Hansastr. 27

32423 Minden

Phone: +49571 887-0 | Fax: +49571 887-169

Email: [info.de@wago.com](mailto:info.de@wago.com) | Web: [www.wago.com](http://www.wago.com)

Do you have any questions about our products?

We are always happy to take your call at +49 (571) 887-44222.

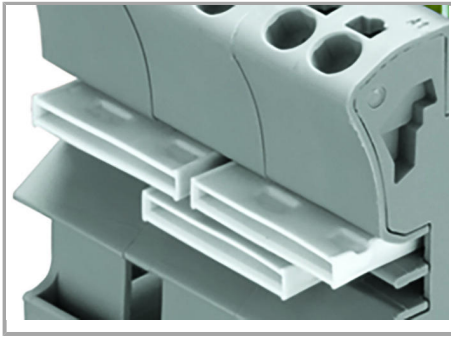

Easy commoning using adjacent jumpers

### Marking

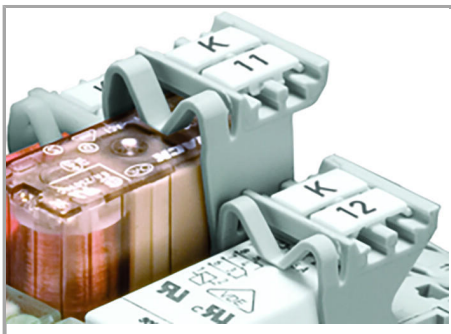

Marking using WMB Multi markers and group marker carriers

Subject to changes. Please also observe the further product documentation!