

Data sheet | Item number: 788-305

Relay module; Nominal input voltage: 48 VDC; 1 changeover contact;
Limiting continuous current: 16 A; Red status indicator; Module width: 15 mm; 2,50 mm²; gray

www.wago.com/788-305

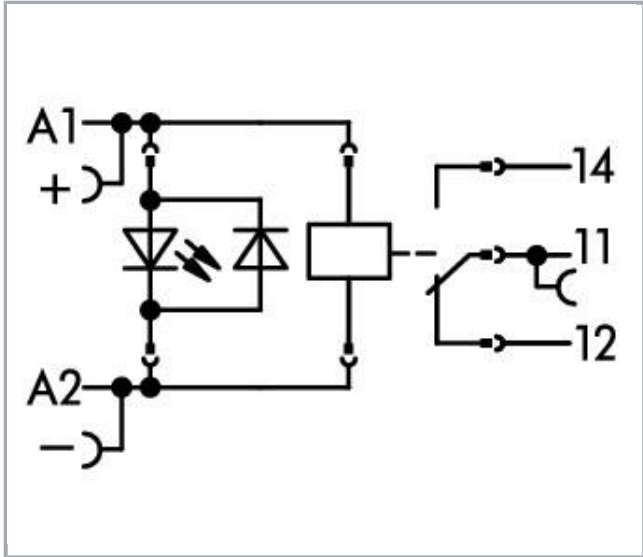
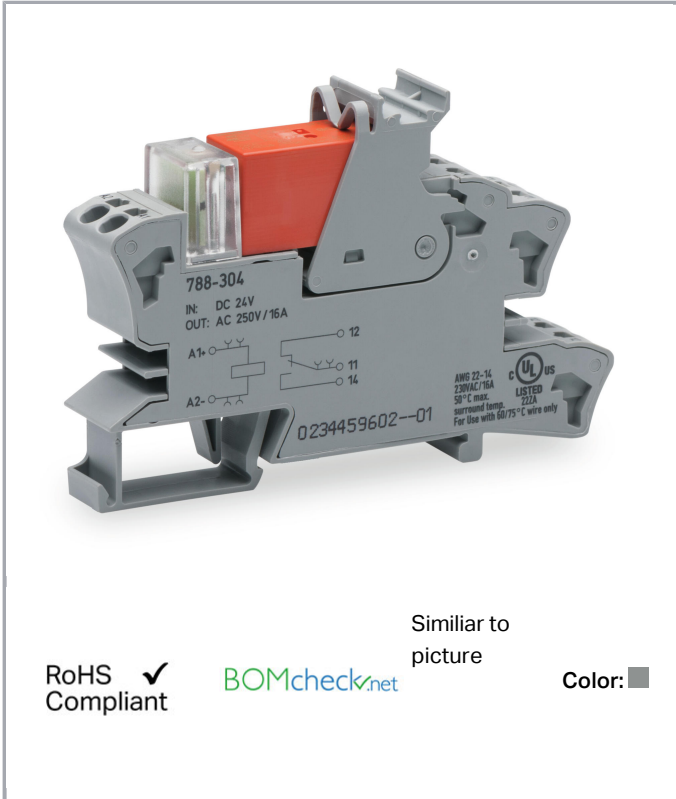

Similar to picture

RoHS Compliant ✓

BOMcheck.net

Color: ■

Subject to changes. Please also observe the further product documentation!

WAGO Kontakttechnik GmbH & Co. KG
Hansastr. 27
32423 Minden
Phone: +49571 887-0 | Fax: +49571 887-169
Email: info.de@wago.com | Web: www.wago.com

Do you have any questions about our products?
We are always happy to take your call at +49 (571) 887-44222.

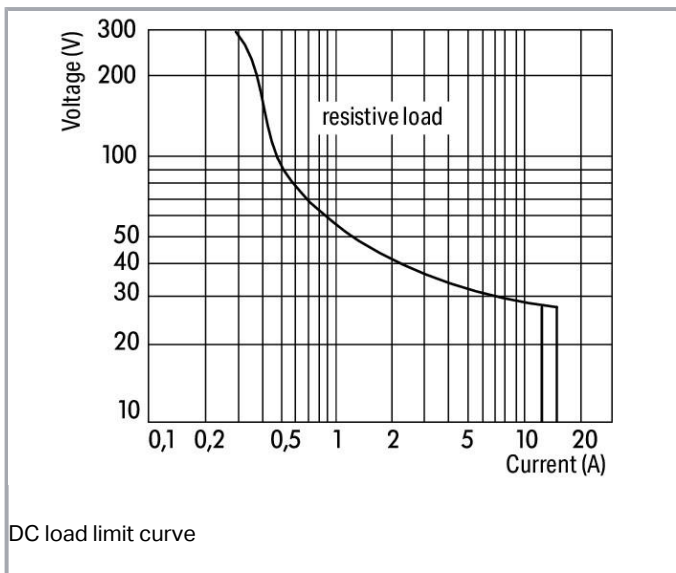
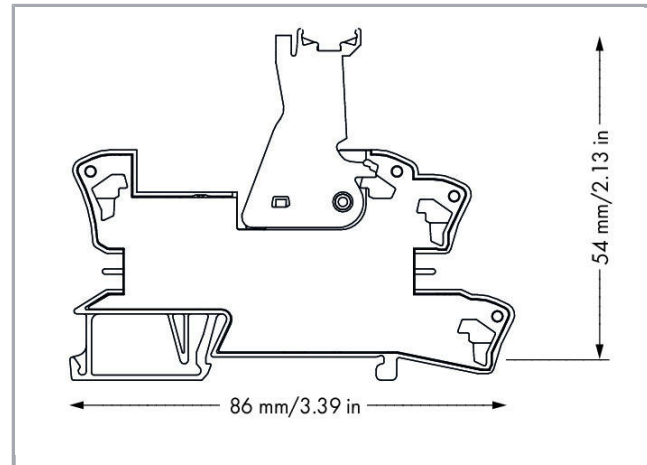
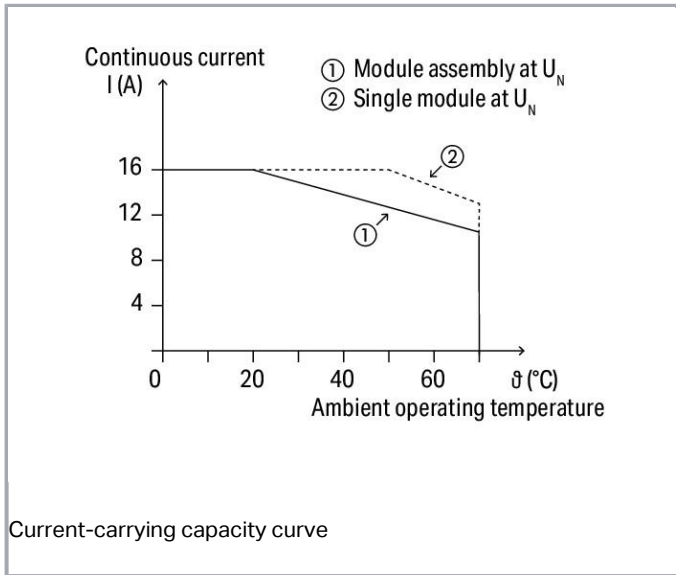

Item description

Note:

- Reinforced insulation between coil and contacts
- A separator plate (e.g., 209-191) must be used for voltages greater than 250 V between adjacent relay modules and for compliance with the reinforced insulation requirements.
- To protect the relay coils and contacts, inductive loads must be dampened with an effective protection circuit.

Subject to changes. Please also observe the further product documentation!

Data**Technical Data****Control circuit**

Nominal input voltage U_N	DC 48 V
Input voltage range	$\pm 10\%$
Nominal input current at U_N	11 mA

Load circuit:

Number of changeover/switchover contacts	1
Contact material (relay)	AgNi 90/10
Limiting continuous current	16 A
Max. make current (resistive)	(AC) 30 A / 4 s
Max. switching voltage	AC 250 V
Max. switching power (resistive)	AC 4000 VA; DC (see load limit curve)
Switching capacity	AC-15: 6 A / AC 250 V; DC-13: 2 A / DC 24 V
Recommended minimum load	12 V / 10 mA
Pull-in time (typ.)	8 ms
Drop-out time (typ.)	6 ms
Bounce time (typ.)	6 ms
Electrical life (N.O.; resistive load; 23 °C)	30×10^3 switching operations
Mechanical life	30×10^6 switching operations
Max. switching load with load/without load	6 min^{-1} / 1200 min^{-1}

Signaling

Status indication	Red LED
-------------------	---------

Safety and protection:

Rated voltage	250 V
Rated impulse voltage	4 kV
Pollution degree	3
Dielectric strength, control/load circuit (AC, 1 min)	5 kVrms
Dielectric strength open contact (AC, 1 min)	1 kVrms
Protection class	IP20

Subject to changes. Please also observe the further product documentation!



Connection data

Connection technology	Push-in CAGE CLAMP®
Solid conductor	0,34 ... 2,5 mm ² / 22 ... 14 AWG
Fine-stranded conductor	0,34 ... 2,5 mm ² / 22 ... 14 AWG
Strip length	9 ... 10 mm / 0.35 ... 0.39 inch

Geometrical Data

Width	15 mm / 0.591 inch
Height from upper-edge of DIN-35 rail	54 mm / 2.126 inch
Depth	86 mm / 3.386 inch

Mechanical data

Type of mounting	DIN-35 rail
------------------	-------------

Material Data

Color	gray
Fire load	0.633 MJ
Weight	45.9 g

Environmental Requirements

Surrounding air (operating) temperature at U _N	-40 ... 70 °C
Surrounding air (storage) temperature	-40 ... 70 °C
Processing temperature	-25 ... +50 °C

Standards and specifications

Standards/specifications	EN 61010-2-201; EN 61810-1; EN 61373; UL 508 (max. 10 A)
--------------------------	--

Elementary relay

WAGO elementary relay	788-158
-----------------------	---------

Commercial data

Product Group	6 (Interface Electronics)
Packaging type	BOX
Country of origin	DE

Subject to changes. Please also observe the further product documentation!

WAGO Kontakttechnik GmbH & Co. KG
 Hansastr. 27
 32423 Minden
 Phone: +49571 887-0 | Fax: +49571 887-169
 Email: info.de@wago.com | Web: www.wago.com

Do you have any questions about our products?
 We are always happy to take your call at +49 (571) 887-44222.

GTIN	4045454550356
Customs Tariff No.	85364900990

Approvals / Certificates

UL-Approvals

Logo	Approval	Additional Approval Text	Certificate name
	UL UL International Netherlands B.V. (ORDINARY LOCATIONS)	UL 508	E175199 Sec.6

Counterpart

Compatible products

General accessories

	Item no.: 209-145 Group marker carrier; white	www.wago.com/209-145
	Item no.: 209-184 Protection cover; transparent	www.wago.com/209-184
	Item no.: 788-121 Accessories for relay modules; Operation status indicator: red	www.wago.com/788-121
	Item no.: 788-158 Basic relay; Nominal input voltage: 48 VDC; 1 changeover contact; Limiting continuous current: 16 A; Module width: 13 mm; Module height: 15 mm	www.wago.com/788-158







tools

	Item no.: 210-720 Operating tool; Blade: 3.5 x 0.5 mm; with a partially insulated shaft	www.wago.com/210-720
--	---	--













Jumper

	Item no.: 788-113 Comb-style jumper bar; 2-way; insulated	www.wago.com/788-113
	Item no.: 788-114 Comb-style jumper bar; 3-way; insulated	www.wago.com/788-114













Subject to changes. Please also observe the further product documentation!

	Item no.: 788-115 Comb-style jumper bar; 4-way; insulated	www.wago.com/788-115
	Item no.: 788-116 Comb-style jumper bar; 6-way; insulated	www.wago.com/788-116
	Item no.: 788-117 Comb-style jumper bar; 8-way; insulated	www.wago.com/788-117
	Item no.: 788-118 Comb-style jumper bar; 2-way (1-3); insulated	www.wago.com/788-118
	Item no.: 859-402 Push-in type jumper bar; 2-way; Nominal current 18 A; insulated; light gray	www.wago.com/859-402
	Item no.: 859-402/000-005 Push-in type jumper bar; 2-way; Nominal current 18 A; insulated; red	www.wago.com/859-402/000-005
	Item no.: 859-402/000-006 Push-in type jumper bar; 2-way; Nominal current 18 A; insulated; blue	www.wago.com/859-402/000-006
	Item no.: 859-402/000-029 Push-in type jumper bar; 2-way; Nominal current 18 A; insulated; yellow	www.wago.com/859-402/000-029
Marking accessories		
	Item no.: 2009-110 Marking strips; on reel; not stretchable; plain; snap-on type; white	www.wago.com/2009-110
	Item no.: 2009-115 WMB-Inline; for Smart Printer; 1500 pieces on roll; stretchable 5 - 5.2 mm; plain; snap-on type; white	www.wago.com/2009-115
	Item no.: 2009-115/000-002 WMB-Inline; for Smart Printer; 1500 pieces on roll; stretchable 5 - 5.2 mm; plain; snap-on type; yellow	www.wago.com/2009-115/000-002
	Item no.: 2009-115/000-006 WMB-Inline; for Smart Printer; 1500 pieces on roll; stretchable 5 - 5.2 mm; plain; snap-on type; white	www.wago.com/2009-115/000-006
	Item no.: 2009-115/000-007 WMB-Inline; for Smart Printer; 1500 pieces on roll; stretchable 5 - 5.2 mm; plain; snap-on type; gray	www.wago.com/2009-115/000-007
	Item no.: 2009-115/000-012 WMB-Inline; for Smart Printer; 1500 pieces on roll; stretchable 5 - 5.2 mm; plain; snap-on type; white	www.wago.com/2009-115/000-012
	Item no.: 2009-115/000-017 WMB-Inline; for Smart Printer; 1500 pieces on roll; stretchable 5 - 5.2 mm; plain; snap-on type; white	www.wago.com/2009-115/000-017

Subject to changes. Please also observe the further product documentation!

	Item no.: 2009-115/000-023 WMB-Inline; for Smart Printer; 1500 pieces on roll; stretchable 5 - 5.2 mm; plain; snap-on type; green	www.wago.com/2009-115/000-023
	Item no.: 209-128 Adaptor; gray	www.wago.com/209-128
	Item no.: 209-183 Marker card; white	www.wago.com/209-183
	Item no.: 210-110 Fiber-tip pen	www.wago.com/210-110
	Item no.: 249-105 Group marker carrier; gray	www.wago.com/249-105
	Item no.: 793-501 WMB marking card; as card; not stretchable; plain; snap-on type; white	www.wago.com/793-501
	Item no.: 793-501/000-002 WMB marking card; as card; not stretchable; plain; snap-on type; yellow	www.wago.com/793-501/000-002
	Item no.: 793-501/000-005 WMB marking card; as card; not stretchable; plain; snap-on type; red	www.wago.com/793-501/000-005
	Item no.: 793-501/000-006 WMB marking card; as card; not stretchable; plain; snap-on type; blue	www.wago.com/793-501/000-006
	Item no.: 793-501/000-007 WMB marking card; as card; not stretchable; plain; snap-on type; gray	www.wago.com/793-501/000-007
	Item no.: 793-501/000-012 WMB marking card; as card; not stretchable; plain; snap-on type; orange	www.wago.com/793-501/000-012
	Item no.: 793-501/000-017 WMB marking card; as card; not stretchable; plain; snap-on type; light green	www.wago.com/793-501/000-017
	Item no.: 793-501/000-023 WMB marking card; as card; not stretchable; plain; snap-on type; green	www.wago.com/793-501/000-023
	Item no.: 793-501/000-024 WMB marking card; as card; not stretchable; plain; snap-on type; violet	www.wago.com/793-501/000-024
	Item no.: 793-502 WMB marking card; as card; MARKED; 1 ... 10 (10x); not stretchable; Horizontal marking; snap-on type; white	www.wago.com/793-502

Subject to changes. Please also observe the further product documentation!

	<p>Item no.: 793-502/000-002 WMB marking card; as card; MARKED; 1 ... 10 (10x); not stretchable; Horizontal marking; snap-on type; yellow</p>	www.wago.com/793-502/000-002
	<p>Item no.: 793-502/000-005 WMB marking card; as card; MARKED; 1 ... 10 (10x); not stretchable; Horizontal marking; snap-on type; red</p>	www.wago.com/793-502/000-005
	<p>Item no.: 793-502/000-006 WMB marking card; as card; MARKED; 1 ... 10 (10x); not stretchable; Horizontal marking; snap-on type; blue</p>	www.wago.com/793-502/000-006
	<p>Item no.: 793-502/000-007 WMB marking card; as card; MARKED; 1 ... 10 (10x); not stretchable; Horizontal marking; snap-on type; gray</p>	www.wago.com/793-502/000-007
	<p>Item no.: 793-502/000-012 WMB marking card; as card; MARKED; 1 ... 10 (10x); not stretchable; Horizontal marking; snap-on type; orange</p>	www.wago.com/793-502/000-012
	<p>Item no.: 793-502/000-017 WMB marking card; as card; MARKED; 1 ... 10 (10x); not stretchable; Horizontal marking; snap-on type; light green</p>	www.wago.com/793-502/000-017
	<p>Item no.: 793-502/000-023 WMB marking card; as card; MARKED; 1 ... 10 (10x); not stretchable; Horizontal marking; snap-on type; green</p>	www.wago.com/793-502/000-023
	<p>Item no.: 793-502/000-024 WMB marking card; as card; MARKED; 1 ... 10 (10x); not stretchable; Horizontal marking; snap-on type; violet</p>	www.wago.com/793-502/000-024
	<p>Item no.: 793-503 WMB marking card; as card; MARKED; 11 ... 20 (10x); not stretchable; Horizontal marking; snap-on type; white</p>	www.wago.com/793-503
	<p>Item no.: 793-503/000-002 WMB marking card; as card; MARKED; 11 ... 20 (10x); not stretchable; Horizontal marking; snap-on type; yellow</p>	www.wago.com/793-503/000-002
	<p>Item no.: 793-503/000-005 WMB marking card; as card; MARKED; 11 ... 20 (10x); not stretchable; Horizontal marking; snap-on type; red</p>	www.wago.com/793-503/000-005
	<p>Item no.: 793-503/000-006 WMB marking card; as card; MARKED; 11 ... 20 (10x); not stretchable; Horizontal marking; snap-on type; blue</p>	www.wago.com/793-503/000-006
	<p>Item no.: 793-503/000-007 WMB marking card; as card; MARKED; 11 ... 20 (10x); not stretchable; Horizontal marking; snap-on type; gray</p>	www.wago.com/793-503/000-007
	<p>Item no.: 793-503/000-012</p>	

Subject to changes. Please also observe the further product documentation!



WMB marking card; as card; MARKED; 11 ... 20 (10x); not stretchable; Horizontal marking; snap-on type; orange

www.wago.com/793-503/000-012



Item no.: 793-503/000-017

WMB marking card; as card; MARKED; 11 ... 20 (10x); not stretchable; Horizontal marking; snap-on type; light green

www.wago.com/793-503/000-017

Item no.: 793-503/000-023

WMB marking card; as card; MARKED; 11 ... 20 (10x); not stretchable; Horizontal marking; snap-on type; green

www.wago.com/793-503/000-023



Item no.: 793-503/000-024

WMB marking card; as card; MARKED; 11 ... 20 (10x); not stretchable; Horizontal marking; snap-on type; violet

www.wago.com/793-503/000-024



Item no.: 793-504

WMB marking card; as card; MARKED; 21 ... 30 (10x); not stretchable; Horizontal marking; snap-on type; white

www.wago.com/793-504



Item no.: 793-504/000-002

WMB marking card; as card; MARKED; 21 ... 30 (10x); not stretchable; Horizontal marking; snap-on type; yellow

www.wago.com/793-504/000-002



Item no.: 793-504/000-005

WMB marking card; as card; MARKED; 21 ... 30 (10x); not stretchable; Horizontal marking; snap-on type; red

www.wago.com/793-504/000-005



Item no.: 793-504/000-006

WMB marking card; as card; MARKED; 21 ... 30 (10x); not stretchable; Horizontal marking; snap-on type; blue

www.wago.com/793-504/000-006



Item no.: 793-504/000-012

WMB marking card; as card; MARKED; 21 ... 30 (10x); not stretchable; Horizontal marking; snap-on type; orange

www.wago.com/793-504/000-012



Item no.: 793-504/000-017

WMB marking card; as card; MARKED; 21 ... 30 (10x); not stretchable; Horizontal marking; snap-on type; light green

www.wago.com/793-504/000-017



Item no.: 793-504/000-023

WMB marking card; as card; MARKED; 21 ... 30 (10x); not stretchable; Horizontal marking; snap-on type; green

www.wago.com/793-504/000-023



Item no.: 793-505

WMB marking card; as card; MARKED; 31 ... 40 (10x); not stretchable; Horizontal marking; snap-on type; white

www.wago.com/793-505



Item no.: 793-505/000-005

WMB marking card; as card; MARKED; 31 ... 40 (10x); not stretchable; Horizontal marking; snap-on type; red

www.wago.com/793-505/000-005

Item no.: 793-505/000-006

WMB marking card; as card; MARKED; 31 ... 40 (10x); not stretchable; Horizontal marking; snap-on type;

Subject to changes. Please also observe the further product documentation!



blue

www.wago.com/793-505/000-006



Item no.: 793-505/000-007

WMB marking card; as card; MARKED; 31 ... 40 (10x); not stretchable; Horizontal marking; snap-on type; gray

www.wago.com/793-505/000-007



Item no.: 793-505/000-012

WMB marking card; as card; MARKED; 31 ... 40 (10x); not stretchable; Horizontal marking; snap-on type; orange

www.wago.com/793-505/000-012



Item no.: 793-506

WMB marking card; as card; MARKED; 41 ... 50 (10x); not stretchable; Horizontal marking; snap-on type; white

www.wago.com/793-506



Item no.: 793-506/000-005

WMB marking card; as card; MARKED; 41 ... 50 (10x); not stretchable; Horizontal marking; snap-on type; red

www.wago.com/793-506/000-005



Item no.: 793-506/000-006

WMB marking card; as card; MARKED; 41 ... 50 (10x); not stretchable; Horizontal marking; snap-on type; blue

www.wago.com/793-506/000-006



Item no.: 793-506/000-012

WMB marking card; as card; MARKED; 41 ... 50 (10x); not stretchable; Horizontal marking; snap-on type; orange

www.wago.com/793-506/000-012



Item no.: 793-506/000-017

WMB marking card; as card; MARKED; 41 ... 50 (10x); not stretchable; Horizontal marking; snap-on type; light green

www.wago.com/793-506/000-017



Item no.: 793-5501

WMB marking card; as card; for terminal block width 5 - 17.5 mm; stretchable 5 - 5.2 mm; plain; snap-on type; white

www.wago.com/793-5501



Item no.: 793-5501/000-002

WMB marking card; as card; for terminal block width 5 - 17.5 mm; stretchable 5 - 5.2 mm; plain; snap-on type; yellow

www.wago.com/793-5501/000-002



Item no.: 793-5501/000-005

WMB marking card; as card; for terminal block width 5 - 17.5 mm; stretchable 5 - 5.2 mm; plain; snap-on type; red

www.wago.com/793-5501/000-005



Item no.: 793-5501/000-006

WMB marking card; as card; for terminal block width 5 - 17.5 mm; stretchable 5 - 5.2 mm; plain; snap-on type; blue

www.wago.com/793-5501/000-006



Item no.: 793-5501/000-007

WMB marking card; as card; for terminal block width 5 - 17.5 mm; stretchable 5 - 5.2 mm; plain; snap-on type; gray

www.wago.com/793-5501/000-007

Item no.: 793-5501/000-012

WMB marking card; as card; for terminal block width 5 - 17.5 mm; stretchable 5 - 5.2 mm; plain; snap-on

Subject to changes. Please also observe the further product documentation!



type; orange

www.wago.com/793-5501/000-012



Item no.: 793-5501/000-014

WMB marking card; as card; for terminal block width 5 - 17.5 mm; stretchable 5 - 5.2 mm; plain; snap-on type; brown

www.wago.com/793-5501/000-014



Item no.: 793-5501/000-017

WMB marking card; as card; for terminal block width 5 - 17.5 mm; stretchable 5 - 5.2 mm; plain; snap-on type; green

www.wago.com/793-5501/000-017



Item no.: 793-5501/000-023

WMB marking card; as card; for terminal block width 5 - 17.5 mm; stretchable 5 - 5.2 mm; plain; snap-on type; light green

www.wago.com/793-5501/000-023



Item no.: 793-5501/000-024

WMB marking card; as card; for terminal block width 5 - 17.5 mm; stretchable 5 - 5.2 mm; plain; snap-on type; violet

www.wago.com/793-5501/000-024



Item no.: 793-566

WMB marking card; as card; MARKED; 1 ... 50 (2x); not stretchable; Horizontal marking; snap-on type; white

www.wago.com/793-566



Item no.: 793-566/000-002

WMB marking card; as card; MARKED; 1 ... 50 (2x); not stretchable; Horizontal marking; snap-on type; yellow

www.wago.com/793-566/000-002



Item no.: 793-566/000-005

WMB marking card; as card; MARKED; 1 ... 50 (2x); not stretchable; Horizontal marking; snap-on type; red

www.wago.com/793-566/000-005



Item no.: 793-566/000-006

WMB marking card; as card; MARKED; 1 ... 50 (2x); not stretchable; Horizontal marking; snap-on type; blue

www.wago.com/793-566/000-006



Item no.: 793-566/000-007

WMB marking card; as card; MARKED; 1 ... 50 (2x); not stretchable; Horizontal marking; snap-on type; gray

www.wago.com/793-566/000-007



Item no.: 793-566/000-012

WMB marking card; as card; MARKED; 1 ... 50 (2x); not stretchable; Horizontal marking; snap-on type; orange

www.wago.com/793-566/000-012



Item no.: 793-566/000-017

WMB marking card; as card; MARKED; 1 ... 50 (2x); not stretchable; Horizontal marking; snap-on type; light green

www.wago.com/793-566/000-017



Item no.: 793-566/000-023

WMB marking card; as card; MARKED; 1 ... 50 (2x); not stretchable; Horizontal marking; snap-on type; green

www.wago.com/793-566/000-023

Item no.: 793-566/000-024

Subject to changes. Please also observe the further product documentation!



WMB marking card; as card; MARKED; 1 ... 50 (2x); not stretchable; Horizontal marking; snap-on type; violet

www.wago.com/793-566/000-024

ferrule



Item no.: 216-241

Ferrule; Sleeve for 0.5 mm² / 20 AWG; insulated; electro-tin plated; electrolytic copper; gastight crimped; acc. to DIN 46228, Part 4/09.90; white

www.wago.com/216-241

Item no.: 216-242

Ferrule; Sleeve for 0.75 mm² / 18 AWG; insulated; electro-tin plated; electrolytic copper; gastight crimped; acc. to DIN 46228, Part 4/09.90; gray

www.wago.com/216-242



Item no.: 216-243

Ferrule; Sleeve for 1 mm² / AWG 18; insulated; electro-tin plated; electrolytic copper; gastight crimped; acc. to DIN 46228, Part 4/09.90; red

www.wago.com/216-243

Item no.: 216-244

Ferrule; Sleeve for 1.5 mm² / AWG 16; insulated; electro-tin plated; electrolytic copper; gastight crimped; acc. to DIN 46228, Part 4/09.90; black

www.wago.com/216-244



Item no.: 216-542

Twin ferrule; Sleeve for 2 x 1 mm² / AWG 2 x 18; red, insulated; 12 mm long; red

www.wago.com/216-542

Downloads

Documentation

Instruction Leaflet

Sockets with Elementary Relay/ SSR	V 1.0.0	pdf 2.4 MB	Download
------------------------------------	---------	---------------	----------

Additional Information

Disposal; Electrical and electronic equipment, Packaging	V 1.0.0	pdf 265.8 kB	Download
--	---------	-----------------	----------

CAD/CAE-Data

CAD data

2D/3D Models 788-305	URL	Download
----------------------	-----	----------

CAE data

EPLAN Data Portal 788-305	URL	Download
---------------------------	-----	----------

WSCAD Universe 788-305	URL	Download
------------------------	-----	----------

Subject to changes. Please also observe the further product documentation!

WAGO Kontakttechnik GmbH & Co. KG
Hansastr. 27
32423 Minden
Phone: +49571 887-0 | Fax: +49571 887-169
Email: info.de@wago.com | Web: www.wago.com

Do you have any questions about our products?
We are always happy to take your call at +49 (571) 887-44222.

Installation Notes

Conductor termination

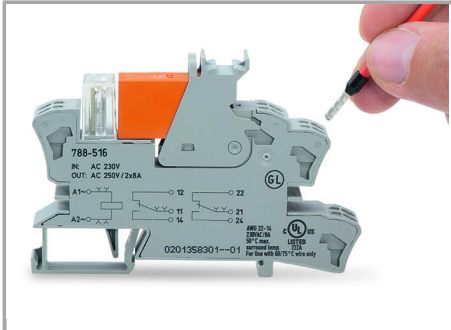

Leiter anschließen

Commoning

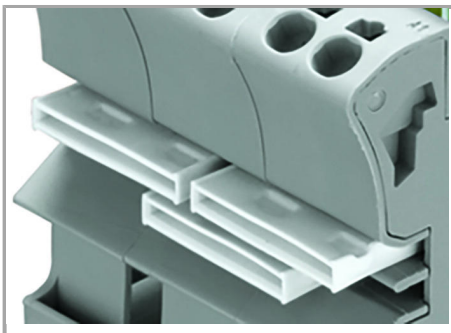

Easy commoning using adjacent jumpers

Marking

Subject to changes. Please also observe the further product documentation!

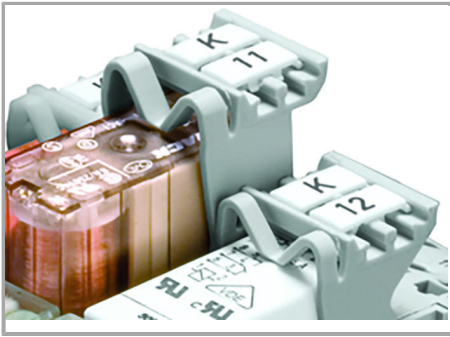

Marking using WMB Multi markers and group marker carriers

Subject to changes. Please also observe the further product documentation!