

Data sheet | Item number: 787-2861/100-000

electronic circuit breaker; 1-channel; 24 VDC input voltage; 1 A;
communication capability

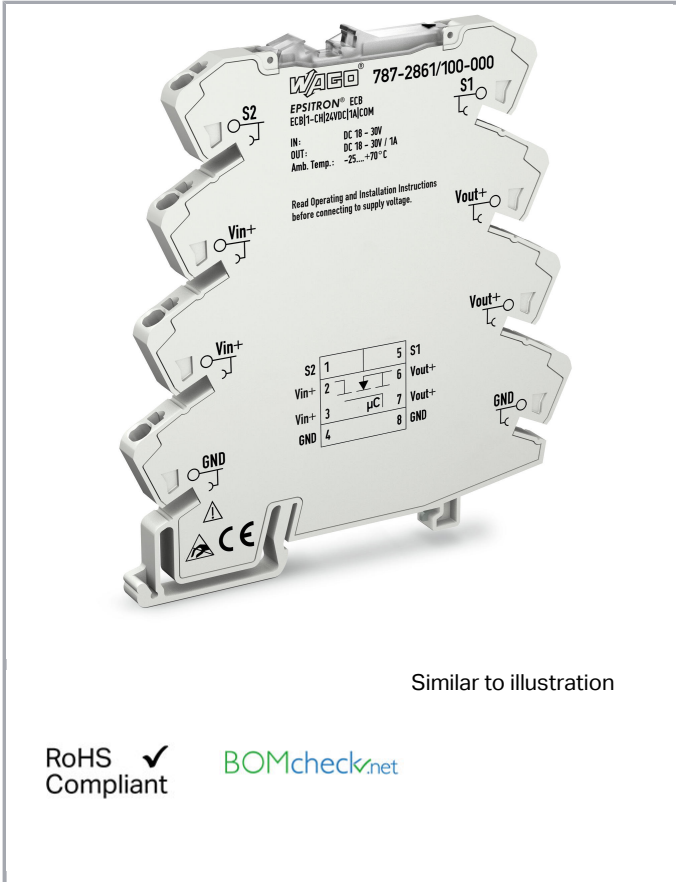

www.wago.com/787-2861/100-000



Similar to illustration

RoHS Compliant

BOMcheck.net

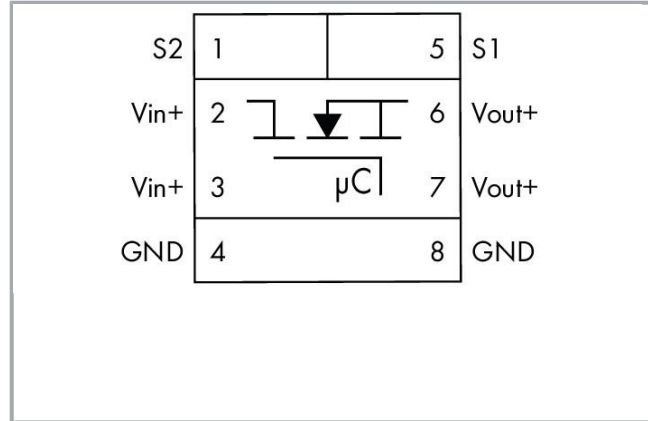

Subject to changes. Please also observe the further product documentation!

WAGO Kontakttechnik GmbH & Co. KG
Hansastr. 27
32423 Minden
Phone: +49571 887-0 | Fax: +49571 887-169
Email: info.de@wago.com | Web: www.wago.com

Do you have any questions about our products?
We are always happy to take your call at +49 (571) 887-44222.

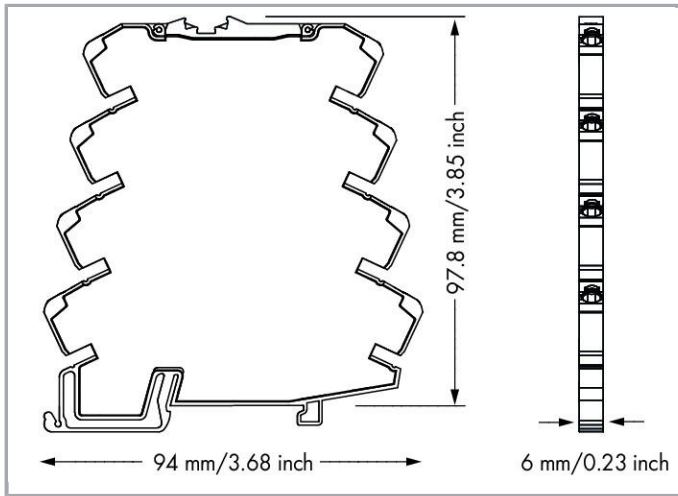

Item description

Features:

- Space-saving ECB with one channel
- Reliably and safely trips in the event of an overload and short circuit on the secondary side
- Switch-on capacity > 50,000 μF
- Enables the use of an economical, standard power supply
- Minimizes wiring via two voltage outputs and maximizes commoning options on both input and output sides (e.g., commoning of the output voltage on 857 and 2857 Series devices)
- Status signal – adjustable as single or group message
- Reset, switch on/off via remote input or local switch
- Prevents power supply overload due to total inrush current thanks to time-delayed switching on during interconnected operation

Data

Technical Data

Input

Nominal input voltage $U_{i \text{ nom}}$	DC 24 V
Input voltage range	DC 18 ... 30 V

Output

Total number of channels (module)	1
Nominal output voltage $U_{o \text{ nom}}$	1 x DC 24 V
Output voltage range	DC 18 ... 30 V (U_e – voltage drop)
Voltage drop	$\leq 50 \text{ mV}$

Subject to changes. Please also observe the further product documentation!



Nominal output current $I_{o\ nom}$	1 x 1 A (fixed setting)
Trip time	4 ms ... 100 s (Load-dependent)
Switch-on capacity	> 50000 μ F per channel
Switch-on behavior	Time-delayed channel switching (load-dependent, min. 170 ms/max. 500 ms)
Active Current Limitation	no

Signaling and communication

Signaling	1 x Status LED (green/yellow/red/blue) 1 x Control input 1 x active signal output (U_i , max. 4 mA)
Operation status indicator	Green LED (channel OK) Red LED (tripped channel)
Remote input	18 ... 30 VDC signal, switches on/off and resets the channel

Efficiency/Power losses:

Power loss P_l	$\leq 0,3$ W (No load)
Efficiency (typ.)	99 %

Fuse protection:

Internal fuse	T 15 A
---------------	--------

Safety and protection:

Insulation voltage (connectors-housing)	DC 0,5 kV
Protection class	III
Protection class	IP20 (per EN 60529)
Reverse voltage protection	No
Transient protection, primary	Suppressor diode (33 V)
Parallel operation of single channels	Not permitted
Series connection	No
MTBF	1,263,074 h (per MIL-HDBK-217F2)

Connection data

Number of jumper slots	8
Connection technology	Push-in CAGE CLAMP®

Subject to changes. Please also observe the further product documentation!



WAGO terminal	WAGO 857 Series
Solid conductor	0,08 ... 2,5 mm ² / 28 ... 14 AWG
Fine-stranded conductor	0,34 ... 2,5 mm ² / 22 ... 14 AWG
Strip length	9 ... 10 mm / 0.35 ... 0.39 inch

Geometrical Data

Width	6 mm / 0.236 inch
Height from upper-edge of DIN-35 rail	97,8 mm / 3.85 inch
Depth	94 mm / 3.701 inch

Mechanical data

Type of mounting	DIN-35 rail (EN 60715)
------------------	------------------------

Material Data

Fire load	0.405 MJ
Weight	37.9 g

Environmental Requirements

Surrounding air (operating) temperature	-25 ... 70 °C
Surrounding air (storage) temperature	-40 ... 85 °C
Relative humidity	10 ... 95 % (no condensation permissible)
Derating	No derating
Pollution degree	2

Standards and specifications

Conformity marking	CE
Standards/specifications	EN 61000-6-2; EN 61000-6-3; UL 61010-2-201; DNV GL* (*pending)

Commercial data

Packaging type	bag
Country of origin	DE
GTIN	4055143533249
Customs Tariff No.	85363010900

Approvals / Certificates

UL-Approvals

Subject to changes. Please also observe the further product documentation!



WAGO Kontakttechnik GmbH & Co. KG
 Hansastr. 27
 32423 Minden
 Phone: +49571 887-0 | Fax: +49571 887-169
 Email: info.de@wago.com | Web: www.wago.com

Do you have any questions about our products?
 We are always happy to take your call at +49 (571) 887-44222.











Logo	Approval	Additional Approval Text	Certificate name
	UL Underwriters Laboratories Inc. (ORDINARY LOCATIONS)	UL 2367	E175199 Vol.3 Sec. 2 Series 0787 ECB

Counterpart











Compatible products

ferrule		
	Item no.: 216-241 Ferrule; Sleeve for 0.5 mm ² / 20 AWG; insulated; electro-tin plated; electrolytic copper; gastight crimped; acc. to DIN 46228, Part 4/09.90; white	www.wago.com/216-241
	Item no.: 216-242 Ferrule; Sleeve for 0.75 mm ² / 18 AWG; insulated; electro-tin plated; electrolytic copper; gastight crimped; acc. to DIN 46228, Part 4/09.90; gray	www.wago.com/216-242
	Item no.: 216-243 Ferrule; Sleeve for 1 mm ² / AWG 18; insulated; electro-tin plated; electrolytic copper; gastight crimped; acc. to DIN 46228, Part 4/09.90; red	www.wago.com/216-243
	Item no.: 216-244 Ferrule; Sleeve for 1.5 mm ² / AWG 16; insulated; electro-tin plated; electrolytic copper; gastight crimped; acc. to DIN 46228, Part 4/09.90; black	www.wago.com/216-244
tools		
	Item no.: 210-720 Operating tool; Blade: 3.5 x 0.5 mm; with a partially insulated shaft	www.wago.com/210-720
Marking accessories		
	Item no.: 2009-110 Marking strips; on reel; not stretchable; plain; snap-on type; white	www.wago.com/2009-110
	Item no.: 2009-115 WMB-Inline; for Smart Printer; 1500 pieces on roll; stretchable 5 - 5.2 mm; plain; snap-on type; white	www.wago.com/2009-115
	Item no.: 2009-115/000-002 WMB-Inline; for Smart Printer; 1500 pieces on roll; stretchable 5 - 5.2 mm; plain; snap-on type; yellow	www.wago.com/2009-115/000-002
	Item no.: 2009-115/000-006 WMB-Inline; for Smart Printer; 1500 pieces on roll; stretchable 5 - 5.2 mm; plain; snap-on type; white	www.wago.com/2009-115/000-006

Subject to changes. Please also observe the further product documentation!

	Item no.: 2009-115/000-007 WMB-Inline; for Smart Printer; 1500 pieces on roll; stretchable 5 - 5.2 mm; plain; snap-on type; gray	www.wago.com/2009-115/000-007
	Item no.: 2009-115/000-012 WMB-Inline; for Smart Printer; 1500 pieces on roll; stretchable 5 - 5.2 mm; plain; snap-on type; white	www.wago.com/2009-115/000-012
	Item no.: 2009-115/000-017 WMB-Inline; for Smart Printer; 1500 pieces on roll; stretchable 5 - 5.2 mm; plain; snap-on type; white	www.wago.com/2009-115/000-017
	Item no.: 2009-115/000-023 WMB-Inline; for Smart Printer; 1500 pieces on roll; stretchable 5 - 5.2 mm; plain; snap-on type; green	www.wago.com/2009-115/000-023
	Item no.: 2009-115/000-024 WMB-Inline; for Smart Printer; 1500 pieces on roll; stretchable 5 - 5.2 mm; plain; snap-on type; white	www.wago.com/2009-115/000-024
	Item no.: 793-501 WMB marking card; as card; not stretchable; plain; snap-on type; white	www.wago.com/793-501
	Item no.: 793-501/000-002 WMB marking card; as card; not stretchable; plain; snap-on type; yellow	www.wago.com/793-501/000-002
	Item no.: 793-501/000-005 WMB marking card; as card; not stretchable; plain; snap-on type; red	www.wago.com/793-501/000-005
	Item no.: 793-501/000-006 WMB marking card; as card; not stretchable; plain; snap-on type; blue	www.wago.com/793-501/000-006
	Item no.: 793-501/000-007 WMB marking card; as card; not stretchable; plain; snap-on type; gray	www.wago.com/793-501/000-007
	Item no.: 793-501/000-012 WMB marking card; as card; not stretchable; plain; snap-on type; orange	www.wago.com/793-501/000-012
	Item no.: 793-501/000-017 WMB marking card; as card; not stretchable; plain; snap-on type; light green	www.wago.com/793-501/000-017
	Item no.: 793-501/000-023 WMB marking card; as card; not stretchable; plain; snap-on type; green	www.wago.com/793-501/000-023
	Item no.: 793-501/000-024 WMB marking card; as card; not stretchable; plain; snap-on type; violet	www.wago.com/793-501/000-024

Subject to changes. Please also observe the further product documentation!

	Item no.: 793-502 WMB marking card; as card; MARKED; 1 ... 10 (10x); not stretchable; Horizontal marking; snap-on type; white	www.wago.com/793-502
	Item no.: 793-502/000-002 WMB marking card; as card; MARKED; 1 ... 10 (10x); not stretchable; Horizontal marking; snap-on type; yellow	www.wago.com/793-502/000-002
	Item no.: 793-502/000-005 WMB marking card; as card; MARKED; 1 ... 10 (10x); not stretchable; Horizontal marking; snap-on type; red	www.wago.com/793-502/000-005
	Item no.: 793-502/000-006 WMB marking card; as card; MARKED; 1 ... 10 (10x); not stretchable; Horizontal marking; snap-on type; blue	www.wago.com/793-502/000-006
	Item no.: 793-502/000-007 WMB marking card; as card; MARKED; 1 ... 10 (10x); not stretchable; Horizontal marking; snap-on type; gray	www.wago.com/793-502/000-007
	Item no.: 793-502/000-012 WMB marking card; as card; MARKED; 1 ... 10 (10x); not stretchable; Horizontal marking; snap-on type; orange	www.wago.com/793-502/000-012
	Item no.: 793-502/000-017 WMB marking card; as card; MARKED; 1 ... 10 (10x); not stretchable; Horizontal marking; snap-on type; light green	www.wago.com/793-502/000-017
	Item no.: 793-502/000-023 WMB marking card; as card; MARKED; 1 ... 10 (10x); not stretchable; Horizontal marking; snap-on type; green	www.wago.com/793-502/000-023
	Item no.: 793-502/000-024 WMB marking card; as card; MARKED; 1 ... 10 (10x); not stretchable; Horizontal marking; snap-on type; violet	www.wago.com/793-502/000-024
	Item no.: 793-503 WMB marking card; as card; MARKED; 11 ... 20 (10x); not stretchable; Horizontal marking; snap-on type; white	www.wago.com/793-503
	Item no.: 793-503/000-002 WMB marking card; as card; MARKED; 11 ... 20 (10x); not stretchable; Horizontal marking; snap-on type; yellow	www.wago.com/793-503/000-002
	Item no.: 793-503/000-005 WMB marking card; as card; MARKED; 11 ... 20 (10x); not stretchable; Horizontal marking; snap-on type; red	www.wago.com/793-503/000-005
	Item no.: 793-503/000-006 WMB marking card; as card; MARKED; 11 ... 20 (10x); not stretchable; Horizontal marking; snap-on type; blue	www.wago.com/793-503/000-006

Subject to changes. Please also observe the further product documentation!



Item no.: 793-503/000-007

WMB marking card; as card; MARKED; 11 ... 20 (10x); not stretchable; Horizontal marking; snap-on type; gray www.wago.com/793-503/000-007



Item no.: 793-503/000-012

WMB marking card; as card; MARKED; 11 ... 20 (10x); not stretchable; Horizontal marking; snap-on type; orange www.wago.com/793-503/000-012



Item no.: 793-503/000-017

WMB marking card; as card; MARKED; 11 ... 20 (10x); not stretchable; Horizontal marking; snap-on type; light green www.wago.com/793-503/000-017

Item no.: 793-503/000-023

WMB marking card; as card; MARKED; 11 ... 20 (10x); not stretchable; Horizontal marking; snap-on type; green www.wago.com/793-503/000-023



Item no.: 793-503/000-024

WMB marking card; as card; MARKED; 11 ... 20 (10x); not stretchable; Horizontal marking; snap-on type; violet www.wago.com/793-503/000-024

Item no.: 793-504

WMB marking card; as card; MARKED; 21 ... 30 (10x); not stretchable; Horizontal marking; snap-on type; white www.wago.com/793-504

Item no.: 793-504/000-002

WMB marking card; as card; MARKED; 21 ... 30 (10x); not stretchable; Horizontal marking; snap-on type; yellow www.wago.com/793-504/000-002



Item no.: 793-504/000-005

WMB marking card; as card; MARKED; 21 ... 30 (10x); not stretchable; Horizontal marking; snap-on type; red www.wago.com/793-504/000-005

Item no.: 793-504/000-006

WMB marking card; as card; MARKED; 21 ... 30 (10x); not stretchable; Horizontal marking; snap-on type; blue www.wago.com/793-504/000-006

Item no.: 793-504/000-012

WMB marking card; as card; MARKED; 21 ... 30 (10x); not stretchable; Horizontal marking; snap-on type; orange www.wago.com/793-504/000-012



Item no.: 793-504/000-017

WMB marking card; as card; MARKED; 21 ... 30 (10x); not stretchable; Horizontal marking; snap-on type; light green www.wago.com/793-504/000-017



Item no.: 793-504/000-023

WMB marking card; as card; MARKED; 21 ... 30 (10x); not stretchable; Horizontal marking; snap-on type; green www.wago.com/793-504/000-023



Item no.: 793-505

WMB marking card; as card; MARKED; 31 ... 40 (10x); not stretchable; Horizontal marking; snap-on type; white www.wago.com/793-505

Item no.: 793-505/000-005

WMB marking card; as card; MARKED; 31 ... 40 (10x); not stretchable; Horizontal marking; snap-on type;

Subject to changes. Please also observe the further product documentation!



red

www.wago.com/793-505/000-005

Item no.: 793-505/000-006

WMB marking card; as card; MARKED; 31 ... 40 (10x); not stretchable; Horizontal marking; snap-on type; blue

www.wago.com/793-505/000-006



Item no.: 793-505/000-007

WMB marking card; as card; MARKED; 31 ... 40 (10x); not stretchable; Horizontal marking; snap-on type; gray

www.wago.com/793-505/000-007

Item no.: 793-505/000-012

WMB marking card; as card; MARKED; 31 ... 40 (10x); not stretchable; Horizontal marking; snap-on type; orange

www.wago.com/793-505/000-012



Item no.: 793-506

WMB marking card; as card; MARKED; 41 ... 50 (10x); not stretchable; Horizontal marking; snap-on type; white

www.wago.com/793-506



Item no.: 793-506/000-005

WMB marking card; as card; MARKED; 41 ... 50 (10x); not stretchable; Horizontal marking; snap-on type; red

www.wago.com/793-506/000-005



Item no.: 793-506/000-006

WMB marking card; as card; MARKED; 41 ... 50 (10x); not stretchable; Horizontal marking; snap-on type; blue

www.wago.com/793-506/000-006



Item no.: 793-506/000-012

WMB marking card; as card; MARKED; 41 ... 50 (10x); not stretchable; Horizontal marking; snap-on type; orange

www.wago.com/793-506/000-012



Item no.: 793-506/000-017

WMB marking card; as card; MARKED; 41 ... 50 (10x); not stretchable; Horizontal marking; snap-on type; light green

www.wago.com/793-506/000-017



Item no.: 793-5501

WMB marking card; as card; for terminal block width 5 - 17.5 mm; stretchable 5 - 5.2 mm; plain; snap-on type; white

www.wago.com/793-5501



Item no.: 793-5501/000-002

WMB marking card; as card; for terminal block width 5 - 17.5 mm; stretchable 5 - 5.2 mm; plain; snap-on type; yellow

www.wago.com/793-5501/000-002



Item no.: 793-5501/000-005

WMB marking card; as card; for terminal block width 5 - 17.5 mm; stretchable 5 - 5.2 mm; plain; snap-on type; red

www.wago.com/793-5501/000-005



Item no.: 793-5501/000-006

WMB marking card; as card; for terminal block width 5 - 17.5 mm; stretchable 5 - 5.2 mm; plain; snap-on type; blue

www.wago.com/793-5501/000-006

Item no.: 793-5501/000-007

WMB marking card; as card; for terminal block width 5 - 17.5 mm; stretchable 5 - 5.2 mm; plain; snap-on

Subject to changes. Please also observe the further product documentation!



type; gray

www.wago.com/793-5501/000-007



Item no.: 793-5501/000-012

WMB marking card; as card; for terminal block width 5 - 17.5 mm; stretchable 5 - 5.2 mm; plain; snap-on type; orange

www.wago.com/793-5501/000-012



Item no.: 793-5501/000-014

WMB marking card; as card; for terminal block width 5 - 17.5 mm; stretchable 5 - 5.2 mm; plain; snap-on type; brown

www.wago.com/793-5501/000-014



Item no.: 793-5501/000-017

WMB marking card; as card; for terminal block width 5 - 17.5 mm; stretchable 5 - 5.2 mm; plain; snap-on type; green

www.wago.com/793-5501/000-017



Item no.: 793-5501/000-023

WMB marking card; as card; for terminal block width 5 - 17.5 mm; stretchable 5 - 5.2 mm; plain; snap-on type; light green

www.wago.com/793-5501/000-023



Item no.: 793-5501/000-024

WMB marking card; as card; for terminal block width 5 - 17.5 mm; stretchable 5 - 5.2 mm; plain; snap-on type; violet

www.wago.com/793-5501/000-024



Item no.: 793-566

WMB marking card; as card; MARKED; 1 ... 50 (2x); not stretchable; Horizontal marking; snap-on type; white

www.wago.com/793-566



Item no.: 793-566/000-002

WMB marking card; as card; MARKED; 1 ... 50 (2x); not stretchable; Horizontal marking; snap-on type; yellow

www.wago.com/793-566/000-002



Item no.: 793-566/000-005

WMB marking card; as card; MARKED; 1 ... 50 (2x); not stretchable; Horizontal marking; snap-on type; red

www.wago.com/793-566/000-005



Item no.: 793-566/000-006

WMB marking card; as card; MARKED; 1 ... 50 (2x); not stretchable; Horizontal marking; snap-on type; blue

www.wago.com/793-566/000-006



Item no.: 793-566/000-007

WMB marking card; as card; MARKED; 1 ... 50 (2x); not stretchable; Horizontal marking; snap-on type; gray

www.wago.com/793-566/000-007



Item no.: 793-566/000-012

WMB marking card; as card; MARKED; 1 ... 50 (2x); not stretchable; Horizontal marking; snap-on type; orange

www.wago.com/793-566/000-012



Item no.: 793-566/000-017

WMB marking card; as card; MARKED; 1 ... 50 (2x); not stretchable; Horizontal marking; snap-on type; light green

www.wago.com/793-566/000-017

Item no.: 793-566/000-023

Subject to changes. Please also observe the further product documentation!



WMB marking card; as card; MARKED; 1 ... 50 (2x); not stretchable; Horizontal marking; snap-on type; green

www.wago.com/793-566/000-023



Item no.: 793-566/000-024

WMB marking card; as card; MARKED; 1 ... 50 (2x); not stretchable; Horizontal marking; snap-on type; violet

www.wago.com/793-566/000-024

Jumper

Item no.: 281-482

Comb-style jumper bar; insulated; 2-way; IN = IN terminal block; gray

www.wago.com/281-482

Item no.: 859-402

Push-in type jumper bar; 2-way; Nominal current 18 A; insulated; light gray

www.wago.com/859-402

Item no.: 859-402/000-005

Push-in type jumper bar; 2-way; Nominal current 18 A; insulated; red

www.wago.com/859-402/000-005

Item no.: 859-402/000-006

Push-in type jumper bar; 2-way; Nominal current 18 A; insulated; blue

www.wago.com/859-402/000-006

Item no.: 859-402/000-029

Push-in type jumper bar; 2-way; Nominal current 18 A; insulated; yellow

www.wago.com/859-402/000-029

Item no.: 859-403

Push-in type jumper bar; 3-way; Nominal current 18 A; insulated; light gray

www.wago.com/859-403

Item no.: 859-403/000-005

Push-in type jumper bar; 3-way; Nominal current 18 A; insulated; red

www.wago.com/859-403/000-005

Item no.: 859-403/000-006

Push-in type jumper bar; 3-way; Nominal current 18 A; insulated; blue

www.wago.com/859-403/000-006

Item no.: 859-403/000-029

Push-in type jumper bar; 3-way; Nominal current 18 A; insulated; yellow

www.wago.com/859-403/000-029

Item no.: 859-404

Push-in type jumper bar; 4-way; Nominal current 18 A; insulated; light gray

www.wago.com/859-404

Item no.: 859-404/000-005

Push-in type jumper bar; 4-way; Nominal current 18 A; insulated; red

www.wago.com/859-404/000-005

Item no.: 859-404/000-006

Push-in type jumper bar; 4-way; Nominal current 18 A; insulated; blue

www.wago.com/859-404/000-006

Subject to changes. Please also observe the further product documentation!

WAGO Kontakttechnik GmbH & Co. KG

Hansastr. 27

32423 Minden

Phone: +49571 887-0 | Fax: +49571 887-169

Email: info.de@wago.com | Web: www.wago.com

Do you have any questions about our products?

We are always happy to take your call at +49 (571) 887-44222.



Item no.: 859-404/000-029 Push-in type jumper bar; 4-way; Nominal current 18 A; insulated; yellow	www.wago.com/859-404/000-029
Item no.: 859-405 Push-in type jumper bar; 5-way; Nominal current 18 A; insulated; light gray	www.wago.com/859-405
Item no.: 859-405/000-005 Push-in type jumper bar; 5-way; Nominal current 18 A; insulated; red	www.wago.com/859-405/000-005
Item no.: 859-405/000-006 Push-in type jumper bar; 5-way; Nominal current 18 A; insulated; blue	www.wago.com/859-405/000-006
Item no.: 859-405/000-029 Push-in type jumper bar; 5-way; Nominal current 18 A; insulated; yellow	www.wago.com/859-405/000-029
Item no.: 859-406 Push-in type jumper bar; 6-way; Nominal current 18 A; insulated; light gray	www.wago.com/859-406
Item no.: 859-406/000-005 Push-in type jumper bar; 6-way; Nominal current 18 A; insulated; red	www.wago.com/859-406/000-005
Item no.: 859-406/000-006 Push-in type jumper bar; 6-way; Nominal current 18 A; insulated; blue	www.wago.com/859-406/000-006
Item no.: 859-406/000-029 Push-in type jumper bar; 6-way; Nominal current 18 A; insulated; yellow	www.wago.com/859-406/000-029
Item no.: 859-407 Push-in type jumper bar; 7-way; Nominal current 18 A; insulated; light gray	www.wago.com/859-407
Item no.: 859-407/000-005 Push-in type jumper bar; 7-way; Nominal current 18 A; insulated; red	www.wago.com/859-407/000-005
Item no.: 859-407/000-006 Push-in type jumper bar; 7-way; Nominal current 18 A; insulated; blue	www.wago.com/859-407/000-006
Item no.: 859-407/000-029 Push-in type jumper bar; 7-way; Nominal current 18 A; insulated; yellow	www.wago.com/859-407/000-029
Item no.: 859-408 Push-in type jumper bar; 8-way; Nominal current 18 A; insulated; light gray	www.wago.com/859-408
Item no.: 859-408/000-005 Push-in type jumper bar; 8-way; Nominal current 18 A; insulated; red	www.wago.com/859-408/000-005

Subject to changes. Please also observe the further product documentation!



Item no.: 859-408/000-006 Push-in type jumper bar; 8-way; Nominal current 18 A; insulated; blue	www.wago.com/859-408/000-006
Item no.: 859-408/000-029 Push-in type jumper bar; 8-way; Nominal current 18 A; insulated; yellow	www.wago.com/859-408/000-029
Item no.: 859-409 Push-in type jumper bar; 9-way; Nominal current 18 A; insulated; light gray	www.wago.com/859-409
Item no.: 859-409/000-005 Push-in type jumper bar; 9-way; Nominal current 18 A; insulated; red	www.wago.com/859-409/000-005
Item no.: 859-409/000-006 Push-in type jumper bar; 9-way; Nominal current 18 A; insulated; blue	www.wago.com/859-409/000-006
Item no.: 859-409/000-029 Push-in type jumper bar; 9-way; Nominal current 18 A; insulated; yellow	www.wago.com/859-409/000-029
Item no.: 859-410 Push-in type jumper bar; 10-way; Nominal current 18 A; insulated; light gray	www.wago.com/859-410
Item no.: 859-410/000-005 Push-in type jumper bar; 10-way; Nominal current 18 A; insulated; red	www.wago.com/859-410/000-005
Item no.: 859-410/000-006 Push-in type jumper bar; 10-way; Nominal current 18 A; insulated; blue	www.wago.com/859-410/000-006
Item no.: 859-410/000-029 Push-in type jumper bar; 10-way; Nominal current 18 A; insulated; yellow	www.wago.com/859-410/000-029

Downloads

Documentation

Manual

Electronic Circuit Breaker 24 VDC / 1...8 A	V 1.3.1 Dec 16, 2019	pdf 3.0 MB	Download
------------------------------------------------	-------------------------	---------------	--------------------------

Instruction Leaflet

Subject to changes. Please also observe the further product documentation!

WAGO Kontakttechnik GmbH & Co. KG
Hansastr. 27
32423 Minden
Phone: +49571 887-0 | Fax: +49571 887-169
Email: info.de@wago.com | Web: www.wago.com

Do you have any questions about our products?
We are always happy to take your call at +49 (571) 887-44222.



Electronic Circuit Breaker	V 1.3.0	pdf 3.8 MB	Download
----------------------------	---------	---------------	----------

Additional Information

Disposal; Electrical and electronic equipment, Packaging	V 1.0.0	pdf 265.8 kB	Download
----------------------------------------------------------	---------	-----------------	----------

CAD/CAE-Data

CAD data

2D/3D Models 787-2861/100-000		URL	Download
-------------------------------	--	-----	----------

CAE data

EPLAN Data Portal 787-2861/100-000		URL	Download
------------------------------------	--	-----	----------

Installation Notes

Subject to changes. Please also observe the further product documentation!