

Data sheet | Item number: 771-8985/117-803

pre-assembled connecting cable; Eca; Socket/open-ended; 5-pole; Cod. L;
H05Z1Z1-F 5G 2.5 mm²; 8 m; 2,50 mm²; dark gray

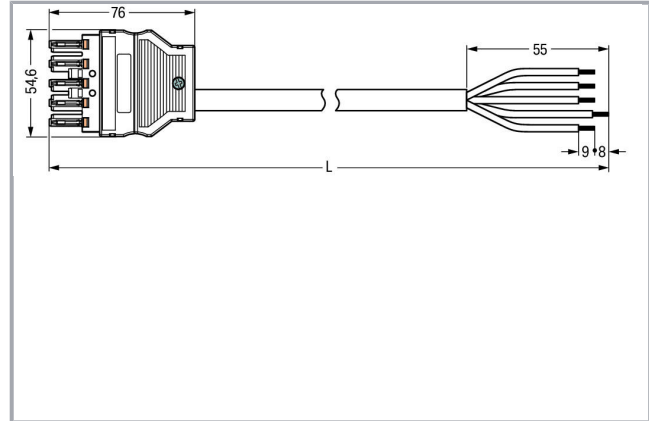

www.wago.com/771-8985/117-803

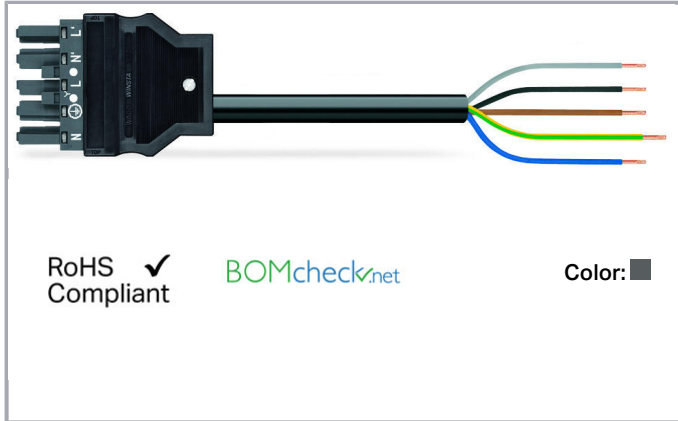

Item description

- Protected against mismatching and maintenance-free

Note:

Cables with a different fire class can be found in the eShop.

Note on mismatching protection:

All WINSTA[®] components are 100% protected against mismatching when:

- plugging different numbers of poles
- plugging while rotated 180
- plugging while laterally staggered
- plugging one pole

Safety information 1:

Application note for the U.S. market (USR): Some versions may also be used for current interruption in accordance with the UL certificate in select applications with currents below 16 A and voltages up to 600 V. For further information, please contact your local sales office.

Data

Electrical data

Note on Contact Resistance

approx. 1 mΩ of contact resistance approx. 0.25 mΩ contact transition plug/socket

Subject to changes. Please also observe the further product documentation!

WAGO Kontakttechnik GmbH & Co. KG
Hansastr. 27
32423 Minden
Phone: +49571 887-0 | Fax: +49571 887-169
Email: info.de@wago.com | Web: www.wago.com

Do you have any questions about our products?
We are always happy to take your call at +49 (571) 887-44222.

Ratings per IEC/EN 60664-1

Ratings per	IEC/EN 60664-1
Rated voltage (III / 3)	400 V
Rated impulse voltage (III / 3)	6 kV
Rated current	20 A
Legend (ratings)	(III / 3) \triangleq Overvoltage category III / Pollution degree 3

Approvals per UL 1977

Rated voltage per UL 1977 (factory wiring only)	600 V
Rated current per UL 1977 (factory wiring only)	23 A

Connection data

No. of poles	5
Total number of potentials	5
Ground function	with preceding ground contact
Conductor preparation	tip-bonded
Cable diameter	11,2 ... 13,9 mm
Cross section of single conductor	2.5 mm ²
Strip length	55 mm
Connection type	Socket - Free end

Geometrical Data

Pin spacing	10 mm / 0.394 inch
Total length	8 m

Mechanical data

Coding	L
Mating force of a plug-in connection	approx. 20 ... 70 N (depending on pole number)
Retention force of a plug-in connection	when locked: > 80N
Unmating force of a plug-in connection	when unlocked: approx. 20 ... 70 N (depending on pole number)
Number of mating cycles	200 (without resistive load) 100 (with resistive load $I_N = 25$ A), tested (4 mm ²)
Connection type	Socket - Free end
Type of cable assembly	Connecting cable
Type of cable	H05Z1Z1-F 5G2.5

Subject to changes. Please also observe the further product documentation!



Marking	N L N' L'
Protection class	IP20
Note on protection class	Only when mated (these compact connectors are not designed for use in open, easily accessible areas).
Potential marking	N L N' L'
Application	Emergency power supply

Plug connection

Mismating protection	Yes
Locking of plug-in connection	locking lever
Locking lever	retrofitable

Material Data

Color	dark gray
Insulating material	Polyamide 66 (PA 66)
Reaction to fire class per EN 50575	E _{ca}
Contact material	Copper or copper alloy (surface-treated)
Connector color	dark gray
Printing color of mating face	white
Strain relief color	black
Printing color of strain relief	white
Color of sheathed cable	black
Printing color of sheathed cable	white
Halogen-free	Yes
Weight	1891.2 g

Environmental Requirements

Processing temperature	-5 ... +40 °C
Continuous operating temperature	-35 ... +85 °C
Note on Continuous Service Temperature	PVC cable for temperatures ≤ 70 °C (including halogen-free) Insulating parts for temperatures ≤ 105 °C

Commercial data

Packaging type	not packed
Country of origin	DE
GTIN	4055143497732
Customs Tariff No.	85444290900



Subject to changes. Please also observe the further product documentation!

WAGO Kontakttechnik GmbH & Co. KG
 Hansastr. 27
 32423 Minden
 Phone: +49571 887-0 | Fax: +49571 887-169
 Email: info.de@wago.com | Web: www.wago.com

Do you have any questions about our products?
 We are always happy to take your call at +49 (571) 887-44222.

Approvals / Certificates





Country specific Approvals

Logo	Approval	Additional Approval Text	Certificate name
	CCA DEKRA Certification B.V.	EN 61535	NTR NL-7355
	KEMA/KEUR DEKRA Certification B.V.	EN 61535	2179129.01

Counterpart

Compatible products

Marking accessories

	Item no.: 210-333 Marking strips; as a DIN A4 sheet; Strip width 6 mm; Strip length 182 mm; plain; Self-adhesive; white	www.wago.com/210-333
	Item no.: 770-450 Marker card; Plastic; white	www.wago.com/770-450
	Item no.: 770-450/000-001 Marker card; Plastic; white	www.wago.com/770-450/000-001
	Item no.: 770-450/000-002 Marker card; Plastic; white	www.wago.com/770-450/000-002
	Item no.: 770-450/000-005 Marker card; Plastic; white	www.wago.com/770-450/000-005
	Item no.: 770-450/000-006 Marker card; Plastic; white	www.wago.com/770-450/000-006
	Item no.: 770-450/000-012 Marker card; Plastic; white	www.wago.com/770-450/000-012

Subject to changes. Please also observe the further product documentation!



protection

Item no.: 770-201

Lockout cap; 12-pole, separable; 12-pole; for sockets; black

www.wago.com/770-201



Item no.: 770-221

Lockout cap; for socket; 12-pole; separable; white

www.wago.com/770-221

Locking lever



Item no.: 770-101

Locking lever; for flying leads; for manual operation; black

www.wago.com/770-101

Item no.: 770-111

Locking lever; for flying leads; for tool operation; black

www.wago.com/770-111

Item no.: 770-121

Locking lever; for flying leads; for manual operation; white

www.wago.com/770-121



Item no.: 770-131

Locking lever; for flying leads; for tool operation; white

www.wago.com/770-131

Downloads

CAD/CAE-Data

CAE data

WSCAD Universe 771-8985/117-803

URL

Download

Installation Notes

Product family

<i>WINSTA</i>® MIDI

[Show all products from the family](#)

Subject to changes. Please also observe the further product documentation!

WAGO Kontakttechnik GmbH & Co. KG

Hansastr. 27

32423 Minden

Phone: +49571 887-0 | Fax: +49571 887-169

Email: info.de@wago.com | Web: www.wago.com

Do you have any questions about our products?

We are always happy to take your call at +49 (571) 887-44222.