

## Data sheet | Item number: 771-5001/172-000

pre-assembled connecting cable; Eca; Plug/open-ended; 5-pole; Cod. I;  
H05Z1Z1-F 2 x 1,50 mm<sup>2</sup>; 1 m; 1,50 mm<sup>2</sup>; blue

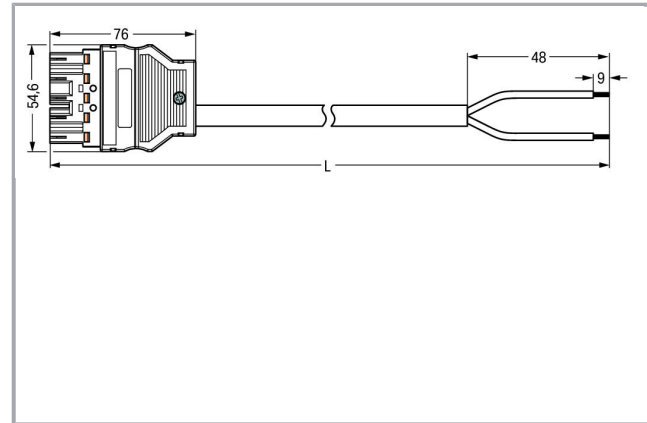

[www.wago.com/771-5001/172-000](http://www.wago.com/771-5001/172-000)

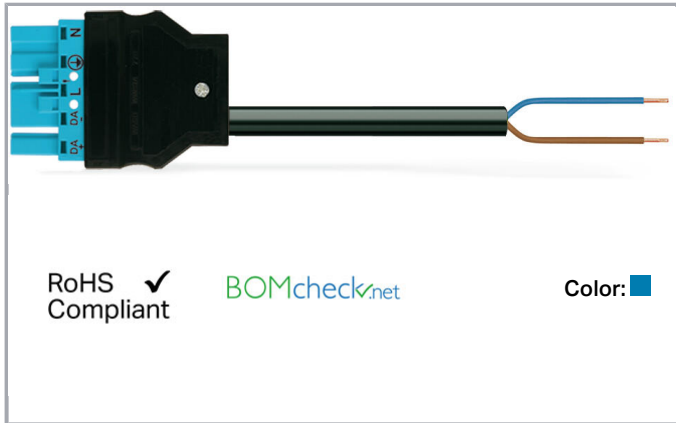

### Item description

- Protected against mismatching and maintenance-free

### Note:

Cables with a different fire class can be found in the eShop.

### Note on mismatching protection:

All WINSTA<sup>®</sup> components are 100% protected against mismatching when:

- plugging different numbers of poles
- plugging while rotated 180
- plugging while laterally staggered
- plugging one pole

### Safety information 1:

Application note for the U.S. market (USR): Some versions may also be used for current interruption in accordance with the UL certificate in select applications with currents below 16 A and voltages up to 600 V. For further information, please contact your local sales office.

## Data

### Electrical data

Note on Contact Resistance

approx. 1 mΩ of contact resistance approx. 0.25 mΩ contact transition plug/socket

Subject to changes. Please also observe the further product documentation!

WAGO Kontakttechnik GmbH & Co. KG  
Hansastr. 27  
32423 Minden  
Phone: +49571 887-0 | Fax: +49571 887-169  
Email: [info.de@wago.com](mailto:info.de@wago.com) | Web: [www.wago.com](http://www.wago.com)

Do you have any questions about our products?  
We are always happy to take your call at +49 (571) 887-44222.

### Ratings per IEC/EN 60664-1

Ratings per	IEC/EN 60664-1
Rated voltage (III / 3)	250 V
Rated impulse voltage (III / 3)	4 kV
Legend (ratings)	(III / 3) $\triangleq$ Overvoltage category III / Pollution degree 3

### Approvals per UL 1977

Rated voltage per UL 1977 (factory wiring only)	600 V
Rated current per UL 1977 (factory wiring only)	23 A

### Connection data

Strip length	9 mm / 0.35 inch
No. of poles	5
Total number of potentials	2
Conductor preparation	tip-bonded
Cable diameter	6,8 ... 8,6 mm
Cross section of single conductor	1.5 mm <sup>2</sup>
Strip length	48 mm
Connection type	Plug - Free end

### Geometrical Data

Pin spacing	10 mm / 0.394 inch
Total length	1 m

### Mechanical data

Technologie	DALI
Coding	I
Mating force of a plug-in connection	approx. 20 ... 70 N (depending on pole number)
Retention force of a plug-in connection	when locked: > 80N
Unmating force of a plug-in connection	when unlocked: approx. 20 ... 70 N (depending on pole number)
Number of mating cycles	200 (without resistive load) 100 (with resistive load $I_N = 25$ A), tested (4 mm <sup>2</sup> )
Connection type	Plug - free end
Type of cable assembly	Connecting cable
Type of cable	H05Z1Z1-F 2x1.5

Subject to changes. Please also observe the further product documentation!



Protection class	IP20
Note on protection class	Only when mated (these compact connectors are not designed for use in open, easily accessible areas).
Application	Lighting management

### Plug connection

Mismating protection	Yes
Locking of plug-in connection	locking lever
Locking lever	retrofitable

### Material Data

Color	blue
Insulating material	Polyamide 66 (PA 66)
Reaction to fire class per EN 50575	E <sub>ca</sub>
Contact material	Copper or copper alloy (surface-treated)
Connector color	blue
Halogen-free	Yes
Weight	106.4 g

### Environmental Requirements

Processing temperature	-5 ... +40 °C
Continuous operating temperature	-35 ... +85 °C
Note on Continuous Service Temperature	PVC cable for temperatures ≤ 70 °C (including halogen-free) Insulating parts for temperatures ≤ 105 °C

### Commercial data

Packaging type	not packed
Country of origin	DE
GTIN	4055143245456
Customs Tariff No.	85444290900

### Counterpart





### Compatible products

Subject to changes. Please also observe the further product documentation!

WAGO Kontakttechnik GmbH & Co. KG  
 Hansastr. 27  
 32423 Minden  
 Phone: +49571 887-0 | Fax: +49571 887-169  
 Email: [info.de@wago.com](mailto:info.de@wago.com) | Web: [www.wago.com](http://www.wago.com)

Do you have any questions about our products?  
 We are always happy to take your call at +49 (571) 887-44222.







### Locking lever

	<b>Item no.: 770-101</b> Locking lever; for flying leads; for manual operation; black	<a href="http://www.wago.com/770-101">www.wago.com/770-101</a>
	<b>Item no.: 770-111</b> Locking lever; for flying leads; for tool operation; black	<a href="http://www.wago.com/770-111">www.wago.com/770-111</a>
	<b>Item no.: 770-121</b> Locking lever; for flying leads; for manual operation; white	<a href="http://www.wago.com/770-121">www.wago.com/770-121</a>
	<b>Item no.: 770-131</b> Locking lever; for flying leads; for tool operation; white	<a href="http://www.wago.com/770-131">www.wago.com/770-131</a>

### protection

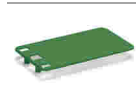
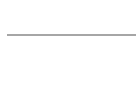
	<b>Item no.: 770-360</b> Lockout cap; for plugs; 5-pole; separable; yellow	<a href="http://www.wago.com/770-360">www.wago.com/770-360</a>
--	---	--

### Marking accessories

	<b>Item no.: 210-333</b> Marking strips; as a DIN A4 sheet; Strip width 6 mm; Strip length 182 mm; plain; Self-adhesive; white	<a href="http://www.wago.com/210-333">www.wago.com/210-333</a>
	<b>Item no.: 770-450</b> Marker card; Plastic; white	<a href="http://www.wago.com/770-450">www.wago.com/770-450</a>
	<b>Item no.: 770-450/000-001</b> Marker card; Plastic; white	<a href="http://www.wago.com/770-450/000-001">www.wago.com/770-450/000-001</a>
	<b>Item no.: 770-450/000-002</b> Marker card; Plastic; white	<a href="http://www.wago.com/770-450/000-002">www.wago.com/770-450/000-002</a>
	<b>Item no.: 770-450/000-005</b> Marker card; Plastic; white	<a href="http://www.wago.com/770-450/000-005">www.wago.com/770-450/000-005</a>
	<b>Item no.: 770-450/000-006</b> Marker card; Plastic; white	<a href="http://www.wago.com/770-450/000-006">www.wago.com/770-450/000-006</a>
	<b>Item no.: 770-450/000-012</b> Marker card; Plastic; white	<a href="http://www.wago.com/770-450/000-012">www.wago.com/770-450/000-012</a>

### Installation Notes

Subject to changes. Please also observe the further product documentation!



## Product family

*WINSTA*® – Specialty Cable Assemblies

[Show all products from the family](#)

Subject to changes. Please also observe the further product documentation!

---

WAGO Kontakttechnik GmbH & Co. KG

Hansastr. 27

32423 Minden

Phone: +49571 887-0 | Fax: +49571 887-169

Email: [info.de@wago.com](mailto:info.de@wago.com) | Web: [www.wago.com](http://www.wago.com)

Do you have any questions about our products?

We are always happy to take your call at +49 (571) 887-44222.