

## Data sheet | Item number: 771-5001/158-000

pre-assembled connecting cable; Eca; Plug/open-ended; 5-pole; Cod. I;  
H05Z1Z1-F 3G 1.5 mm<sup>2</sup>; 3 m; 1,50 mm<sup>2</sup>; blue

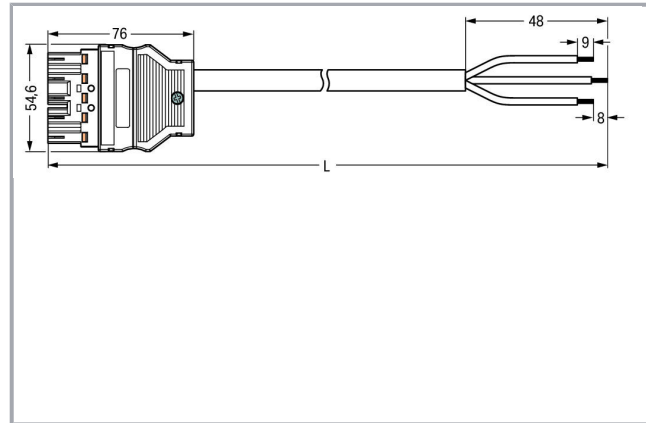

[www.wago.com/771-5001/158-000](http://www.wago.com/771-5001/158-000)

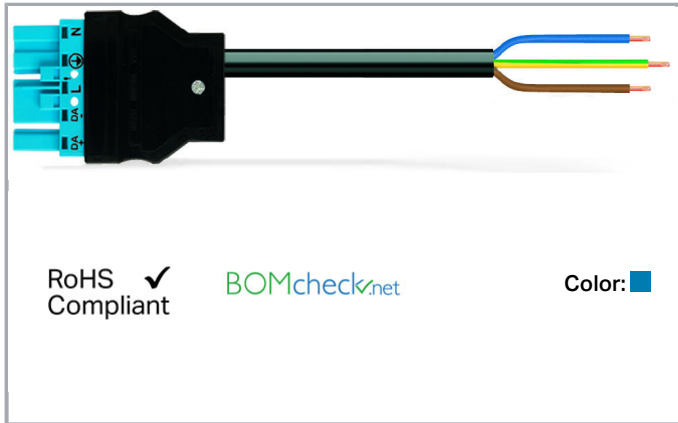

### Item description

- Protected against mismatching and maintenance-free

### Note:

Cables with a different fire class can be found in the eShop.

### Note on mismatching protection:

All WINSTA<sup>®</sup> components are 100% protected against mismatching when:

- plugging different numbers of poles
- plugging while rotated 180
- plugging while laterally staggered
- plugging one pole

### Safety information 1:

Application note for the U.S. market (USR): Some versions may also be used for current interruption in accordance with the UL certificate in select applications with currents below 16 A and voltages up to 600 V. For further information, please contact your local sales office.

## Data

### Electrical data

Note on Contact Resistance

approx. 1 m $\Omega$  of contact resistance approx. 0.25 m $\Omega$  contact transition plug/socket

Subject to changes. Please also observe the further product documentation!

WAGO Kontakttechnik GmbH & Co. KG  
Hansastr. 27  
32423 Minden  
Phone: +49571 887-0 | Fax: +49571 887-169  
Email: [info.de@wago.com](mailto:info.de@wago.com) | Web: [www.wago.com](http://www.wago.com)

Do you have any questions about our products?  
We are always happy to take your call at +49 (571) 887-44222.



### Ratings per IEC/EN 60664-1

|                                 |   |
|---------------------------------|---|
| Ratings per                     | IEC/EN 60664-1  |
| Rated voltage (III / 3)         | 250 V   |
| Rated impulse voltage (III / 3) | 4 kV  |
| Legend (ratings)                | (III / 3) $\hat{=}$ Overvoltage category III / Pollution degree 3 |

### Approvals per UL 1977

|   |       |
|---|-------|
| Rated voltage per UL 1977 (factory wiring only) | 600 V |
| Rated current per UL 1977 (factory wiring only) | 23 A  |

### Connection data

|                                   |                               |
|-----------------------------------|-------------------------------|
| Strip length                      | 9 mm / 0.35 inch              |
| No. of poles                      | 5                             |
| Total number of potentials        | 3                             |
| Ground function                   | with preceding ground contact |
| Conductor preparation             | tip-bonded                    |
| Cable diameter                    | 7,4 ... 9,4 mm                |
| Cross section of single conductor | 1.5 mm <sup>2</sup>           |
| Strip length                      | 48 mm                         |
| Connection type                   | Plug - Free end               |

### Geometrical Data

|              |                    |
|--------------|--------------------|
| Pin spacing  | 10 mm / 0.394 inch |
| Total length | 3 m                |

### Mechanical data

|   |  |
|---|--|
| Technologie                             | DALI   |
| Coding                                  | I  |
| Mating force of a plug-in connection    | approx. 20 ... 70 N (depending on pole number)   |
| Retention force of a plug-in connection | when locked: > 80N   |
| Unmating force of a plug-in connection  | when unlocked: approx. 20 ... 70 N (depending on pole number)                                    |
| Number of mating cycles                 | 200 (without resistive load) 100 (with resistive load $I_N = 25$ A), tested (4 mm <sup>2</sup> ) |
| Connection type                         | Plug - free end  |
| Type of cable assembly                  | Connecting cable   |

Subject to changes. Please also observe the further product documentation!



|                          |   |
|--------------------------|---|
| Type of cable            | H05Z1Z1-F 3G1.5   |
| Protection class         | IP20  |
| Note on protection class | Only when mated (these compact connectors are not designed for use in open, easily accessible areas). |
| Application              | Lighting management   |

### Plug connection

|                               |               |
|-------------------------------|---------------|
| Mismating protection          | Yes           |
| Locking of plug-in connection | locking lever |
| Locking lever                 | retrofitable  |

### Material Data

|                                     |  |
|-------------------------------------|--|
| Color                               | blue                                     |
| Insulating material                 | Polyamide 66 (PA 66)                     |
| Reaction to fire class per EN 50575 | E <sub>ca</sub>                          |
| Contact material                    | Copper or copper alloy (surface-treated) |
| Connector color                     | blue                                     |
| Halogen-free                        | Yes                                      |
| Weight                              | 320.9 g                                  |

### Environmental Requirements

|  |   |
|--|---|
| Processing temperature                 | -5 ... +40 °C   |
| Continuous operating temperature       | -35 ... +85 °C  |
| Note on Continuous Service Temperature | PVC cable for temperatures ≤ 70 °C (including halogen-free)<br>Insulating parts for temperatures ≤ 105 °C |

### Commercial data

|                    |               |
|--------------------|---------------|
| Packaging type     | not packed    |
| Country of origin  | DE            |
| GTIN               | 4055143261173 |
| Customs Tariff No. | 85444290900   |

### Counterpart







Subject to changes. Please also observe the further product documentation!

WAGO Kontakttechnik GmbH & Co. KG  
 Hansastr. 27  
 32423 Minden  
 Phone: +49571 887-0 | Fax: +49571 887-169  
 Email: [info.de@wago.com](mailto:info.de@wago.com) | Web: [www.wago.com](http://www.wago.com)





Do you have any questions about our products?  
 We are always happy to take your call at +49 (571) 887-44222.

## Compatible products

### Marking accessories

|  |   |  |
|--|---|--|
|   | <b>Item no.: 210-333</b><br>Marking strips; as a DIN A4 sheet; Strip width 6 mm; Strip length 182 mm; plain; Self-adhesive; white | <a href="http://www.wago.com/210-333">www.wago.com/210-333</a>                 |
|   | <b>Item no.: 770-450</b><br>Marker card; Plastic; white   | <a href="http://www.wago.com/770-450">www.wago.com/770-450</a>                 |
|   | <b>Item no.: 770-450/000-001</b><br>Marker card; Plastic; white   | <a href="http://www.wago.com/770-450/000-001">www.wago.com/770-450/000-001</a> |
|   | <b>Item no.: 770-450/000-002</b><br>Marker card; Plastic; white   | <a href="http://www.wago.com/770-450/000-002">www.wago.com/770-450/000-002</a> |
|   | <b>Item no.: 770-450/000-005</b><br>Marker card; Plastic; white   | <a href="http://www.wago.com/770-450/000-005">www.wago.com/770-450/000-005</a> |
|   | <b>Item no.: 770-450/000-006</b><br>Marker card; Plastic; white   | <a href="http://www.wago.com/770-450/000-006">www.wago.com/770-450/000-006</a> |
|  | <b>Item no.: 770-450/000-012</b><br>Marker card; Plastic; white   | <a href="http://www.wago.com/770-450/000-012">www.wago.com/770-450/000-012</a> |

### Locking lever

|   |  |  |
|---|--|--|
|  | <b>Item no.: 770-101</b><br>Locking lever; for flying leads; for manual operation; black | <a href="http://www.wago.com/770-101">www.wago.com/770-101</a> |
|  | <b>Item no.: 770-111</b><br>Locking lever; for flying leads; for tool operation; black   | <a href="http://www.wago.com/770-111">www.wago.com/770-111</a> |
|   | <b>Item no.: 770-121</b><br>Locking lever; for flying leads; for manual operation; white | <a href="http://www.wago.com/770-121">www.wago.com/770-121</a> |
|   | <b>Item no.: 770-131</b><br>Locking lever; for flying leads; for tool operation; white   | <a href="http://www.wago.com/770-131">www.wago.com/770-131</a> |

### protection

|  |   |  |
|--|---|--|
|  | <b>Item no.: 770-360</b><br>Lockout cap; for plugs; 5-pole; separable; yellow | <a href="http://www.wago.com/770-360">www.wago.com/770-360</a> |
|--|---|--|

Subject to changes. Please also observe the further product documentation!



## Installation Notes

## Product family

*WINSTA*® – Specialty Cable Assemblies

Show all products from the family

Subject to changes. Please also observe the further product documentation!

---

WAGO Kontakttechnik GmbH & Co. KG  
Hansastr. 27  
32423 Minden  
Phone: +49571 887-0 | Fax: +49571 887-169  
Email: [info.de@wago.com](mailto:info.de@wago.com) | Web: [www.wago.com](http://www.wago.com)

Do you have any questions about our products?  
We are always happy to take your call at +49 (571) 887-44222.