

## Data sheet | Item number: 770-993

h-distribution connector; 5-pole; Cod. I; 1 input; 2 outputs; outputs on both sides; 3 locking levers; for flying leads; blue

[www.wago.com/770-993](http://www.wago.com/770-993)

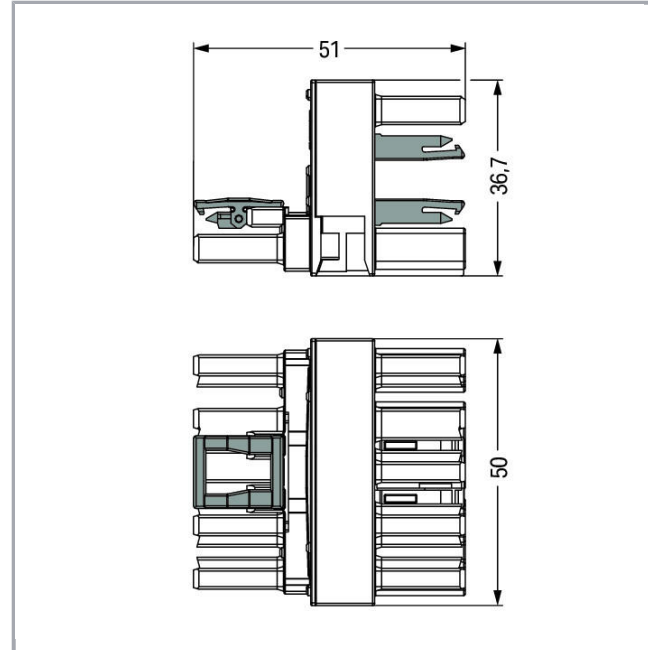
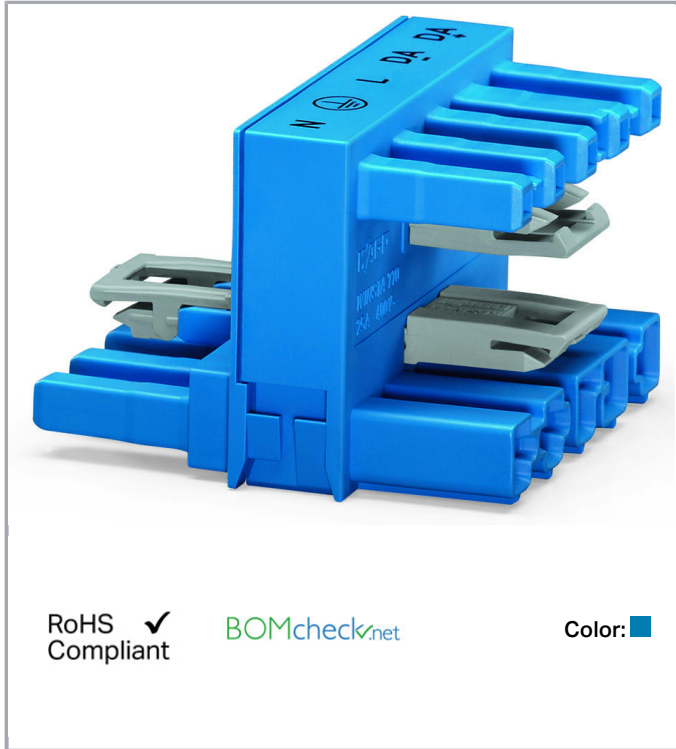

### Item description

- Protected against mismatching and maintenance-free
- Additional variable coding is possible

### Note:

All connectors for mounted installations (snap-in versions for lighting fixtures or devices, all types of PCB and distribution connectors) are factory-equipped with locking levers to ensure plugs and sockets are securely locked. Additional locking levers are only required for flying leads (plug /socket).

### Note on mismatching protection:

All WINSTA<sup>®</sup> components are 100% protected against mismatching when:

- a.) plugging different numbers of poles
- b.) plugging while rotated 180
- c.) plugging while laterally staggered
- d.) plugging one pole

### Safety information 1:

Application note for the U.S. market (USR): Some versions may also be used for current interruption in accordance with the UL certificate in select applications with currents below 16 A and voltages up to 600 V. For further information, please contact your local sales office.

Subject to changes. Please also observe the further product documentation!

WAGO Kontakttechnik GmbH & Co. KG  
Hansastr. 27  
32423 Minden  
Phone: +49571 887-0 | Fax: +49571 887-169  
Email: [info.de@wago.com](mailto:info.de@wago.com) | Web: [www.wago.com](http://www.wago.com)

Do you have any questions about our products?  
We are always happy to take your call at +49 (571) 887-44222.



## Data

### Electrical data

Note on Contact Resistance	approx. 1 mΩ of contact resistance approx. 0.25 mΩ contact transition plug/socket
----------------------------	---

### Ratings per IEC/EN 60664-1

Ratings per	IEC/EN 60664-1
Rated voltage (III / 3)	400 V
Rated impulse voltage (III / 3)	6 kV
Rated current	25 A
Legend (ratings)	(III / 3) ≙ Overvoltage category III / Pollution degree 3

### Approvals per UL 1977

Rated voltage per UL 1977 (factory wiring only)	600 V
Rated current per UL 1977 (factory wiring only)	23 A

### Connection data

No. of poles	5
Total number of potentials	5
Ground function	with preceding ground contact

### Geometrical Data

Pin spacing	10 mm / 0.394 inch
Width	50 mm / 1.969 inch
Height	36,7 mm / 1.445 inch
Depth	46 mm / 1.811 inch

### Mechanical data

Technologie	DALI
Coding	I
Mating force of a plug-in connection	approx. 20 ... 70 N (depending on pole number)
Retention force of a plug-in connection	When locked: > 80 N
Unmating force of a plug-in connection	when unlocked: approx. 20 ... 70 N (depending on pole number)
Number of mating cycles	200, without resistive load 100, with resistive load $I_N = 25$ A, tested (4 mm <sup>2</sup> /AWG 12)

Subject to changes. Please also observe the further product documentation!



Type of distribution connector	h-distribution connector (bi-directional)
Marking	N L DA- DA+
Protection class	IP20
Note on protection class	Only when mated (these compact connectors are not designed for use in open, easily accessible areas).
Potential marking	N L DA- DA+
Application	Lighting management
Suitable	for flying leads

### Plug connection

Contact type (pluggable connector)	Socket/plug
Mismating protection	Yes
Locking of plug-in connection	locking lever
Locking lever	yes
Number of locking levers	3

### Material Data

Color	blue
Insulating material	Polyamide 66 (PA 66)
Contact material	Copper or copper alloy (surface-treated)
Fire load	0.638 MJ
Weight	38.4 g

### Environmental Requirements

Processing temperature	-5 ... +40 °C
Continuous operating temperature	-35 ... +85 °C
Note on Continuous Service Temperature	Insulating parts for temperatures ≤ 105 °C

### Commercial data

Product Group	20 (WINSTA)
Packaging type	BOX
Country of origin	DE
GTIN	4045454853433
Customs Tariff No.	85366990990

Subject to changes. Please also observe the further product documentation!

WAGO Kontakttechnik GmbH & Co. KG  
 Hansastr. 27  
 32423 Minden  
 Phone: +49571 887-0 | Fax: +49571 887-169  
 Email: [info.de@wago.com](mailto:info.de@wago.com) | Web: [www.wago.com](http://www.wago.com)







Do you have any questions about our products?  
 We are always happy to take your call at +49 (571) 887-44222.

## Approvals / Certificates

### UL-Approvals

Logo	Approval	Additional Approval Text	Certificate name
	cURus Underwriters Laboratories Inc.	UL 1977	E45171 Sec. 9

### Counterpart

	<b>Item no.770-1105</b> Socket; 5-pole; Cod. I; 4,00 mm <sup>2</sup> ; blue	<a href="http://www.wago.com/770-1105">www.wago.com/770-1105</a>
	<b>Item no.770-1105/022-000</b> Socket; with strain relief housing; 5-pole; Cod. I; 4,00 mm <sup>2</sup> ; blue	<a href="http://www.wago.com/770-1105/022-000">www.wago.com/770-1105/022-000</a>
	<b>Item no.770-1115</b> Plug; 5-pole; Cod. I; 4,00 mm <sup>2</sup> ; blue	<a href="http://www.wago.com/770-1115">www.wago.com/770-1115</a>
	<b>Item no.770-1115/022-000</b> Plug; with strain relief housing; 5-pole; Cod. I; 4,00 mm <sup>2</sup> ; blue	<a href="http://www.wago.com/770-1115/022-000">www.wago.com/770-1115/022-000</a>
	<b>Item no.771-9985/006-101</b> pre-assembled interconnecting cable; Eca; Socket/plug; 5-pole; Cod. I; H05VV-F 5G 1.5 mm <sup>2</sup> ; 1 m; 1,50 mm <sup>2</sup> ; blue	<a href="http://www.wago.com/771-9985/006-101">www.wago.com/771-9985/006-101</a>
	<b>Item no.771-9985/106-101</b> pre-assembled connecting cable; Eca; Socket/open-ended; 5-pole; Cod. I; H05VV-F 5G 1.5 mm <sup>2</sup> ; 1 m; 1,50 mm <sup>2</sup> ; blue	<a href="http://www.wago.com/771-9985/106-101">www.wago.com/771-9985/106-101</a>
	<b>Item no.771-9985/206-101</b> pre-assembled connecting cable; Eca; Plug/open-ended; 5-pole; Cod. I; H05VV-F 5G 1.5 mm <sup>2</sup> ; 1 m; 1,50 mm <sup>2</sup> ; blue	<a href="http://www.wago.com/771-9985/206-101">www.wago.com/771-9985/206-101</a>

### Compatible products

#### assembling

<b>Item no.: 770-625</b> Mounting plate; 5-pole; for distribution connectors; Plastic; black	<a href="http://www.wago.com/770-625">www.wago.com/770-625</a>
<b>Item no.: 770-675</b> Mounting plate; 5-pole; for distribution connectors; Plastic; white	<a href="http://www.wago.com/770-675">www.wago.com/770-675</a>

#### protection

 <b>Item no.: 770-201</b> Lockout cap; 12-pole, separable; 12-pole; for sockets; black	<a href="http://www.wago.com/770-201">www.wago.com/770-201</a>
---	--

Subject to changes. Please also observe the further product documentation!



Item no.: 770-221  
Lockout cap; for socket; 12-pole; separable; white

[www.wago.com/770-221](http://www.wago.com/770-221)



Item no.: 770-360  
Lockout cap; for plugs; 5-pole; separable; yellow

[www.wago.com/770-360](http://www.wago.com/770-360)

## Downloads

### CAD/CAE-Data

#### CAE data

WSCAD Universe 770-993

URL

Download

## Installation Notes

### Installation

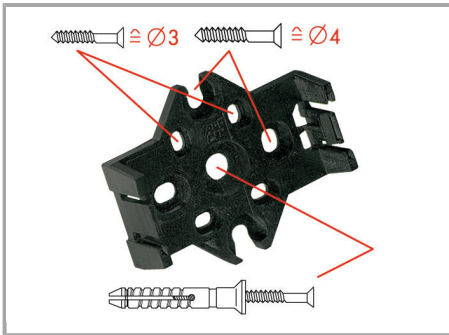

The mounting plate for distribution connectors can be mounted using commercially available screws or nail-drive anchors.



The distribution connectors are latched when mounted on the mounting plate.



To release the distribution connector, unlock the latch using a screwdriver.

Subject to changes. Please also observe the further product documentation!

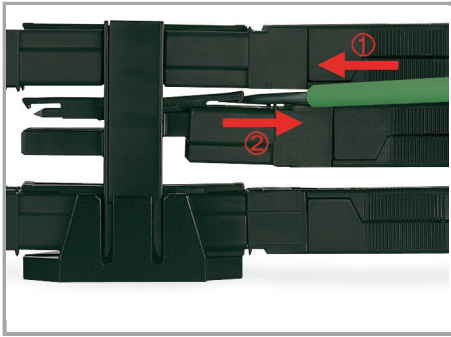

All distributor connections are locked and protected against accidental disconnection directly after mating. Locking of any connection is released using a screwdriver, even if all connections are in use.

## Product family

*WINSTA*® MIDI

[Show all products from the family](#)

Subject to changes. Please also observe the further product documentation!