

Item description

- Protected against mismatching and maintenance-free
- Additional variable coding is possible

Note:

All connectors for mounted installations (snap-in versions for lighting fixtures or devices, all types of PCB and distribution connectors) are factory-equipped with locking levers to ensure plugs and sockets are securely locked. Additional locking levers are only required for flying leads (plug /socket).

Note on mismatching protection:

All WINSTA[®] components are 100% protected against mismatching when:

- plugging different numbers of poles
- plugging while rotated 180
- plugging while laterally staggered
- plugging one pole

Safety information 1:

Subject to changes. Please also observe the further product documentation!



Application note for the U.S. market (USR): Some versions may also be used for current interruption in accordance with the UL certificate in select applications with currents below 16 A and voltages up to 600 V. For further information, please contact your local sales office.

Data

Electrical data

Note on Contact Resistance	approx. 1 mΩ of contact resistance approx. 0.25 mΩ contact transition plug/socket
----------------------------	---

Ratings per IEC/EN 60664-1

Ratings per	IEC/EN 60664-1
Rated voltage (III / 3)	400 V
Rated impulse voltage (III / 3)	6 kV
Rated current	25 A
Legend (ratings)	(III / 3) ≙ Overvoltage category III / Pollution degree 3

Approvals per UL 1977

Rated voltage per UL 1977 (factory wiring only)	600 V
Rated current per UL 1977 (factory wiring only)	23 A

Connection data

No. of poles	5
Total number of potentials	5
Ground function	with preceding ground contact

Geometrical Data

Pin spacing	10 mm / 0.394 inch
Width	50 mm / 1.969 inch
Height	36,7 mm / 1.445 inch
Depth	46 mm / 1.811 inch

Mechanical data

Coding	P
Mating force of a plug-in connection	approx. 20 ... 70 N (depending on pole number)
Retention force of a plug-in connection	When locked: > 80 N
Unmating force of a plug-in connection	when unlocked: approx. 20 ... 70 N (depending on pole number)
Number of mating cycles	200, without resistive load 100, with resistive load $I_N = 25$ A, tested

Subject to changes. Please also observe the further product documentation!



	(4 mm ² /AWG 12)
Type of distribution connector	Distribution connector, 3-way,
Marking	N L1 L2 L3
Protection class	IP20
Note on protection class	Only when mated (these compact connectors are not designed for use in open, easily accessible areas).
Potential marking	N L1 L2 L3
Application	Computer applications (UPS)

Plug connection

Contact type (pluggable connector)	Socket/plug
Mismating protection	Yes
Locking of plug-in connection	locking lever
Locking lever	yes

Material Data

Color	red
Insulating material	Polyamide 66 (PA 66)
Contact material	Copper or copper alloy (surface-treated)
Fire load	0.655 MJ
Weight	41.7 g

Environmental Requirements

Processing temperature	-5 ... +40 °C
Continuous operating temperature	-35 ... +85 °C
Note on Continuous Service Temperature	Insulating parts for temperatures ≤ 105 °C

Commercial data

Product Group	20 (WINSTA)
Packaging type	BOX
Country of origin	DE
GTIN	4045454945268
Customs Tariff No.	85366990990

Approvals / Certificates

UL-Approvals

Certificate





Subject to changes. Please also observe the further product documentation!

WAGO Kontakttechnik GmbH & Co. KG
 Hansastr. 27
 32423 Minden
 Phone: +49571 887-0 | Fax: +49571 887-169
 Email: info.de@wago.com | Web: www.wago.com

Do you have any questions about our products?
 We are always happy to take your call at +49 (571) 887-44222.



Logo	Approval	Additional Approval Text	name
	cURus Underwriters Laboratories Inc.	UL 1977	E45171 Sec. 9

Counterpart



	Item no.770-1305 Socket; 5-pole; Cod. P; 4,00 mm ² ; red	www.wago.com/770-1305
	Item no.770-1315 Plug; 5-pole; Cod. P; 4,00 mm ² ; red	www.wago.com/770-1315
	Item no.771-9975/006-101 pre-assembled interconnecting cable; Eca; Socket/plug; 5-pole; Cod. P; H05VV-F 5G 1.5 mm ² ; 1 m; 1,50 mm ² ; red	www.wago.com/771-9975/006-101
	Item no.771-9975/106-101 pre-assembled connecting cable; Eca; Socket/open-ended; 5-pole; Cod. P; H05VV-F 5G 1.5 mm ² ; 1 m; 1,50 mm ² ; red	www.wago.com/771-9975/106-101
	Item no.771-9975/206-101 pre-assembled connecting cable; Eca; Plug/open-ended; 5-pole; Cod. P; H05VV-F 5G 1.5 mm ² ; 1 m; 1,50 mm ² ; red	www.wago.com/771-9975/206-101

Compatible products

assembling

	Item no.: 770-625 Mounting plate; 5-pole; for distribution connectors; Plastic; black	www.wago.com/770-625
	Item no.: 770-675 Mounting plate; 5-pole; for distribution connectors; Plastic; white	www.wago.com/770-675

protection

	Item no.: 770-201 Lockout cap; 12-pole, separable; 12-pole; for sockets; black	www.wago.com/770-201
	Item no.: 770-221 Lockout cap; for socket; 12-pole; separable; white	www.wago.com/770-221
	Item no.: 770-360 Lockout cap; for plugs; 5-pole; separable; yellow	www.wago.com/770-360

Subject to changes. Please also observe the further product documentation!

Downloads

CAD/CAE-Data

CAE data

WSCAD Universe 770-909

URL

Download

Installation Notes

Installation

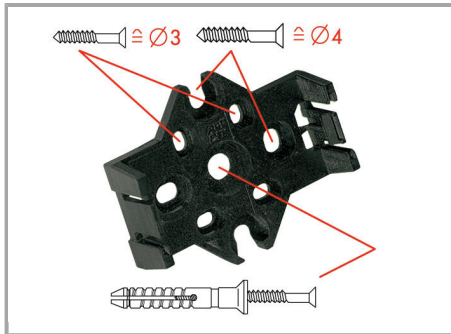

The mounting plate for distribution connectors can be mounted using commercially available screws or nail-drive anchors.



The distribution connectors are latched when mounted on the mounting plate.



To release the distribution connector, unlock the latch using a screwdriver.

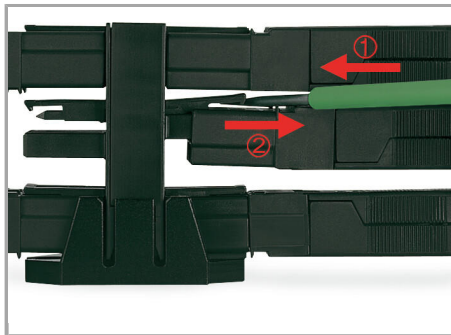

All distributor connections are locked and protected against accidental disconnection directly after mating. Locking of any connection is released using a screwdriver, even if all connections are in use.

Product family

<i>WINSTA</i>® MIDI

[Show all products from the family](#)

Subject to changes. Please also observe the further product documentation!

WAGO Kontakttechnik GmbH & Co. KG

Hansastr. 27

32423 Minden

Phone: +49571 887-0 | Fax: +49571 887-169

Email: info.de@wago.com | Web: www.wago.com

Do you have any questions about our products?

We are always happy to take your call at +49 (571) 887-44222.