

Data sheet | Item number: 770-418

Device connector; 3-pole; Cod. A; Plug module with locking lever; Plastic; black

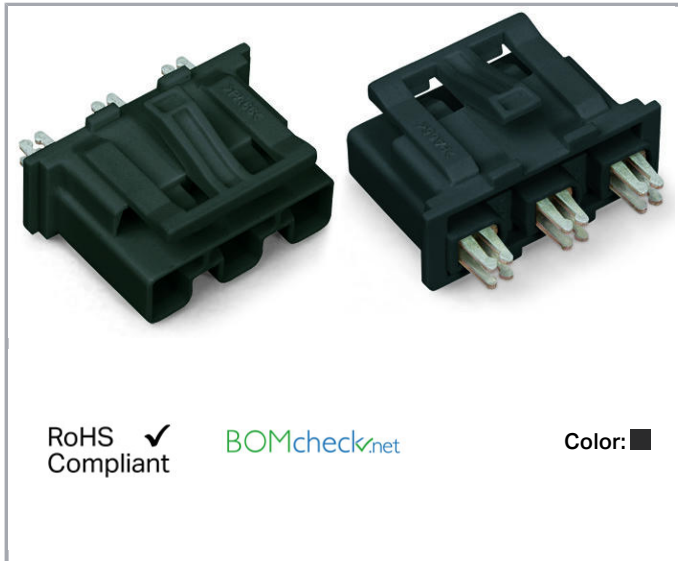

www.wago.com/770-418



RoHS Compliant

[BOMcheck.net](https://www.bomcheck.net)

Color:

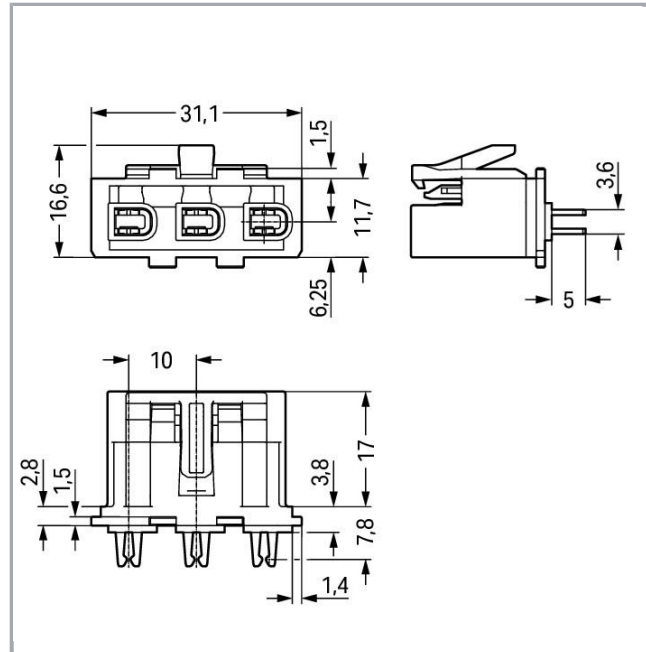

Item description

- Protected against mismatching and maintenance-free
- Push-in CAGE CLAMP® spring pressure connection technology allows solid conductors to be simply pushed into a unit
- Two-wire connection per pole for loops or bridges
- Additional variable coding is possible

Note on mismatching protection:

All WINSTA® components are 100% protected against mismatching when:

- a.) plugging different numbers of poles
- b.) plugging while rotated 180
- c.) plugging while laterally staggered
- d.) plugging one pole

Safety information 1:

Application note for the U.S. market (USR): Some versions may also be used for current interruption in accordance with the UL certificate in select applications with currents below 16 A and voltages up to 600 V. For further information, please contact your local sales office.

Subject to changes. Please also observe the further product documentation!

WAGO Kontakttechnik GmbH & Co. KG
Hansastr. 27
32423 Minden
Phone: +49571 887-0 | Fax: +49571 887-169
Email: info.de@wago.com | Web: www.wago.com

Do you have any questions about our products?
We are always happy to take your call at +49 (571) 887-44222.



Data

Electrical data

Note on Contact Resistance	approx. 1 mΩ of contact resistance approx. 0.25 mΩ contact transition plug/socket
----------------------------	---

Ratings per IEC/EN 60664-1

Ratings per	IEC/EN 60664-1
Rated voltage (III / 3)	250 V
Rated impulse voltage (III / 3)	4 kV
Rated current	25 A
Legend (ratings)	(III / 3) ≙ Overvoltage category III / Pollution degree 3

Approvals per UL 1977

Rated voltage per UL 1977 (factory wiring only)	600 V
Rated current per UL 1977 (factory wiring only)	23 A

Connection data

Note (strip length)	see also packaging or instructions
No. of poles	3
Total number of potentials	3

Geometrical Data

Pin spacing	10 mm / 0.394 inch
Width	31,1 mm / 1.224 inch
Height	24,8 mm / 0.976 inch
Depth	16,55 mm / 0.652 inch

Mechanical data

Coding	A
Mating force of a plug-in connection	approx. 20 ... 70 N (depending on pole number)
Retention force of a plug-in connection	Locked: > 80 N
Unmating force of a plug-in connection	Unlocked: approx. 20 ... 70 N (depending on pole number)
Number of mating cycles	200, without resistive load

Subject to changes. Please also observe the further product documentation!

100, with resistive load $I_N = 25$ A, tested (4 mm²/AWG 12)

Protection class	IP20
Application	General mains applications

Plug connection

Contact type (pluggable connector)	Male connector/plug
Connector connection type	for current bar
Mismating protection	Yes
Locking of plug-in connection	locking lever
Locking lever	yes

Material Data

Color	black
Insulating material	Polyamide 66 (PA 66)
Clamping spring material	Chrome nickel spring steel (CrNi)
Contact material	Copper or copper alloy (surface-treated)
Fire load	0.099 MJ
Weight	5 g

Environmental Requirements

Processing temperature	-5 ... +40 °C
Continuous operating temperature	-35 ... +85 °C
Note on Continuous Service Temperature	Insulating parts for temperatures ≤ 105 °C

Commercial data

Product Group	20 (WINSTA)
Packaging type	BOX
Country of origin	DE
GTIN	4045454522896
Customs Tariff No.	85366990990

Approvals / Certificates

Country specific Approvals

Certificate



Subject to changes. Please also observe the further product documentation!

WAGO Kontakttechnik GmbH & Co. KG
 Hansastr. 27
 32423 Minden
 Phone: +49571 887-0 | Fax: +49571 887-169
 Email: info.de@wago.com | Web: www.wago.com



Do you have any questions about our products?
 We are always happy to take your call at +49 (571) 887-44222.

Logo	Approval	Additional Approval Text	name
	CCA DEKRA Certification B.V.	EN 61535	2173495.02
	CCA DEKRA Certification B.V.	IEC 61535	NL-32105

Ship Approvals

Logo	Approval	Additional Approval Text	Certificate name
	ABS American Bureau of Shipping	-	19- HG1868589- PDA
	DNV GL Det Norske Veritas, Germanischer Lloyd	-	TAE00001Z6
	LR Lloyds Register	IEC 61984	02/20050 (E6)

Counterpart

	Item no.770-408 Device connector; 3-pole; Cod. A; black	www.wago.com/770-408
	Item no.771-9993/006-101 pre-assembled interconnecting cable; Eca; Socket/plug; 3-pole; Cod. A; H05VV-F 3G 1.5 mm ² ; 1 m; 1,50 mm ² ; black	www.wago.com/771-9993/006-101
	Item no.771-9993/106-101 pre-assembled connecting cable; Eca; Socket/open-ended; 3-pole; Cod. A; H05VV-F 3G 1.5 mm ² ; 1 m; 1,50 mm ² ; black	www.wago.com/771-9993/106-101

Compatible products

protection

Item no.: 770-360 Lockout cap; for plugs; 5-pole; separable; yellow	www.wago.com/770-360
--	--

Subject to changes. Please also observe the further product documentation!

Downloads

CAD/CAE-Data

CAD data

2D/3D Models 770-418	URL	Download
----------------------	---------------------	--------------------------

CAE data

EPLAN Data Portal 770-418	URL	Download
---------------------------	---------------------	--------------------------

WSCAD Universe 770-418	URL	Download
------------------------	---------------------	--------------------------

Installation Notes

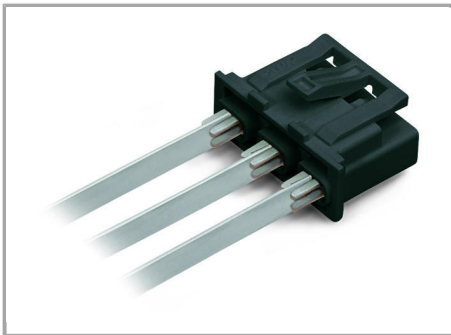

Device connectors can be cost-effectively installed in appropriate guide slots of a housing. Internal electrical connection is performed by contacting the 0.8 mm thick current bars.

Product family

WINSTA[®] MIDI

[Show all products from the family](#)

Subject to changes. Please also observe the further product documentation!