

### Item description

- Protected against mismatching and maintenance-free
- Push-in CAGE CLAMP® spring pressure connection technology allows solid conductors to be simply pushed into a unit
- Two-wire connection per pole for loops or bridges
- Additional variable coding is possible
- Components can be clearly printed on and color-coded to meet custom requirements

#### Note:

All connectors for mounted installations (snap-in versions for lighting fixtures or devices, all types of PCB and distribution connectors) are factory-equipped with locking levers to ensure plugs and sockets are securely locked. Additional locking levers are only required for flying leads (plug /socket).

#### Note on mismatching protection:

All WINSTA® components are 100% protected against mismatching when:

- a.) plugging different numbers of poles
- b.) plugging while rotated 180
- c.) plugging while laterally staggered
- d.) plugging one pole

#### Safety information 1:

Application note for the U.S. market (USR): Some versions may also be used for current interruption in accordance with the UL certificate in select applications with currents below 16 A and voltages up to 600 V. For further information, please contact your local sales office.

Subject to changes. Please also observe the further product documentation!



## Data

### Electrical data

Note on Contact Resistance	approx. 1 mΩ of contact resistance approx. 0.25 mΩ contact transition plug/socket
----------------------------	---

### Ratings per IEC/EN 60664-1

Ratings per	IEC/EN 60664-1
Rated voltage (III / 3)	250 V
Rated impulse voltage (III / 3)	4 kV
Rated current	25 A
Legend (ratings)	(III / 3) ≙ Overvoltage category III / Pollution degree 3

### Approvals per UL 1977

Rated voltage per UL 1977 (factory wiring only)	600 V
Rated current per UL 1977 (factory wiring only)	23 A

### Connection data

Connection technology	Push-in CAGE CLAMP®
Actuation type	Operating tool Push-in
Nominal cross section	4 mm <sup>2</sup>
Solid conductor	0,5 ... 4 mm <sup>2</sup> / 20 ... 12 AWG
Solid conductor, push-in termination	1,5 ... 4 mm <sup>2</sup> / 16 ... 12 AWG
Stranded conductor	0,5 ... 2,5 mm <sup>2</sup> / 20 ... 14 AWG
Fine-stranded conductor	0,5 ... 4 mm <sup>2</sup> / 20 ... 12 AWG
Fine-stranded conductor with ferrule with plastic collar	0,25 ... 1,5 mm <sup>2</sup> / 20 ... 16 AWG
Fine-stranded conductor with ferrule without plastic collar	0,25 ... 2,5 mm <sup>2</sup> / 20 ... 14 AWG
Fine-stranded conductor with ferrule, push-in termination, from	1,5 mm <sup>2</sup> / 16 AWG
Strip length	9 mm / 0.35 inch
Note (strip length)	see also packaging or instructions
No. of poles	3
Total number of connection points	6
Total number of potentials	3
Conductor entry direction to mating direction	0°

Subject to changes. Please also observe the further product documentation!

WAGO Kontakttechnik GmbH & Co. KG  
 Hansastr. 27  
 32423 Minden  
 Phone: +49571 887-0 | Fax: +49571 887-169  
 Email: [info.de@wago.com](mailto:info.de@wago.com) | Web: [www.wago.com](http://www.wago.com)

Do you have any questions about our products?  
 We are always happy to take your call at +49 (571) 887-44222.



## Geometrical Data

Pin spacing	10 mm / 0.394 inch
Width	30 mm / 1.181 inch
Height	12,9 mm / 0.508 inch
Depth	37,5 mm / 1.476 inch

## Mechanical data

Coding	B
Mating force of a plug-in connection	approx. 20 ... 70 N (depending on pole number)
Retention force of a plug-in connection	Locked: > 80 N
Unmating force of a plug-in connection	Unlocked: approx. 20 ... 70 N (depending on pole number)
Number of mating cycles	200, without resistive load 100, with resistive load $I_N = 25$ A, tested (4 mm <sup>2</sup> /AWG 12)
Marking	1 2 3
Protection class	IP20
Note on protection class	In mated condition with strain relief housing: IP2xC (These compact connectors are not designed for use in open, easily accessible areas.)
Potential marking	1 2 3

## Plug connection

Contact type (pluggable connector)	Female connector/socket
Connector connection type	for conductor
Mismating protection	Yes
Locking of plug-in connection	locking lever
Locking lever	retrofittable

## Material Data

Color	pink
Insulating material	Polyamide 66 (PA 66)
Clamping spring material	Chrome nickel spring steel (CrNi)
Contact material	Copper or copper alloy (surface-treated)
Fire load	0.162 MJ

Subject to changes. Please also observe the further product documentation!

WAGO Kontakttechnik GmbH & Co. KG  
 Hansastr. 27  
 32423 Minden  
 Phone: +49571 887-0 | Fax: +49571 887-169  
 Email: [info.de@wago.com](mailto:info.de@wago.com) | Web: [www.wago.com](http://www.wago.com)

Do you have any questions about our products?  
 We are always happy to take your call at +49 (571) 887-44222.

Weight	8.5 g
--------	-------

### Environmental Requirements

Processing temperature	-5 ... +40 °C
Continuous operating temperature	-35 ... +85 °C
Note on Continuous Service Temperature	Insulating parts for temperatures ≤ 105 °C

### Commercial data

Product Group	20 (WINSTA)
Packaging type	BOX
Country of origin	DE
GTIN	4050821451129
Customs Tariff No.	85366990990

### Approvals / Certificates

#### Country specific Approvals

Logo	Approval	Additional Approval Text	Certificate name
	CCA DEKRA Certification B.V.	IEC 61984	NL-32104
	CCA DEKRA Certification B.V.	EN 61984	2173495.01

#### Ship Approvals

Logo	Approval	Additional Approval Text	Certificate name
	ABS American Bureau of Shipping	-	19- HG1868589- PDA
	DNV GL Det Norske Veritas, Germanischer Lloyd	-	TAE00001Z6
	LR Lloyds Register	IEC 61984	02/20050 (E6)

Subject to changes. Please also observe the further product documentation!









WAGO Kontakttechnik GmbH & Co. KG  
 Hansastr. 27  
 32423 Minden  
 Phone: +49571 887-0 | Fax: +49571 887-169  
 Email: [info.de@wago.com](mailto:info.de@wago.com) | Web: [www.wago.com](http://www.wago.com)

Do you have any questions about our products?  
 We are always happy to take your call at +49 (571) 887-44222.

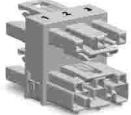
UL-Approvals

Logo	Approval	Additional Approval Text	Certificate name
	cURus Underwriters Laboratories Inc.	UL 1977	E45171 Sec. 9

Counterpart

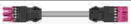
	<b>Item no.770-1613</b> T-distribution connector; 3-pole; Cod. B; 1 input; 2 outputs; 2 locking levers; pink	<a href="http://www.wago.com/770-1613">www.wago.com/770-1613</a>
	<b>Item no.770-1663</b> h-distribution connector; 3-pole; Cod. B; 1 input; 2 outputs; outputs on one side; 2 locking levers; pink	<a href="http://www.wago.com/770-1663">www.wago.com/770-1663</a>
	<b>Item no.770-1716</b> 3-way distribution connector; 3-pole; Cod. B; 1 input; 3 outputs; pink	<a href="http://www.wago.com/770-1716">www.wago.com/770-1716</a>
	<b>Item no.770-1713</b> T-distribution connector; 3-pole; Cod. B; 1 input; 2 outputs; 3 locking levers; for flying leads; pink	<a href="http://www.wago.com/770-1713">www.wago.com/770-1713</a>
	<b>Item no.770-1763</b> h-distribution connector; 3-pole; Cod. B; 1 input; 2 outputs; outputs on one side; 3 locking levers; for flying leads; pink	<a href="http://www.wago.com/770-1763">www.wago.com/770-1763</a>
	<b>Item no.770-293</b> Plug; 3-pole; Cod. B; 4,00 mm <sup>2</sup> ; pink	<a href="http://www.wago.com/770-293">www.wago.com/770-293</a>
	<b>Item no.770-793</b> Snap-in plug; 3-pole; Cod. B; 4,00 mm <sup>2</sup> ; pink	<a href="http://www.wago.com/770-793">www.wago.com/770-793</a>
	<b>Item no.770-893/011-000</b> Plug for PCBs; angled; 3-pole; Cod. B; pink	<a href="http://www.wago.com/770-893/011-000">www.wago.com/770-893/011-000</a>
	<b>Item no.770-893</b> Plug for PCBs; straight; 3-pole; Cod. B; pink	<a href="http://www.wago.com/770-893">www.wago.com/770-893</a>
	<b>Item no.771-9993/005-107</b>	<a href="http://www.wago.com/771-9993">www.wago.com/771-9993</a>

Subject to changes. Please also observe the further product documentation!

	pre-assembled interconnecting cable; Eca; Socket/plug; 3-pole; Cod. B; 1 m; 1,00 mm <sup>2</sup> ; pink	/005-107
	<b>Item no. 771-9993/205-107</b> pre-assembled connecting cable; Eca; Plug/open-ended; 3-pole; Cod. B; 1 m; 1,00 mm <sup>2</sup> ; pink	<a href="http://www.wago.com/771-9993/205-107">www.wago.com/771-9993/205-107</a>

## Compatible products

### tools

	<b>Item no.: 210-719</b> Operating tool; Blade: 2.5 x 0.4 mm; with a partially insulated shaft	<a href="http://www.wago.com/210-719">www.wago.com/210-719</a>
	<b>Item no.: 770-383</b> Operating tool; 3-way; green	<a href="http://www.wago.com/770-383">www.wago.com/770-383</a>

### protection

	<b>Item no.: 770-201</b> Lockout cap; 12-pole, separable; 12-pole; for sockets; black	<a href="http://www.wago.com/770-201">www.wago.com/770-201</a>
	<b>Item no.: 770-221</b> Lockout cap; for socket; 12-pole; separable; white	<a href="http://www.wago.com/770-221">www.wago.com/770-221</a>

### Locking lever

	<b>Item no.: 770-101</b> Locking lever; for flying leads; for manual operation; black	<a href="http://www.wago.com/770-101">www.wago.com/770-101</a>
	<b>Item no.: 770-111</b> Locking lever; for flying leads; for tool operation; black	<a href="http://www.wago.com/770-111">www.wago.com/770-111</a>
	<b>Item no.: 770-121</b> Locking lever; for flying leads; for manual operation; white	<a href="http://www.wago.com/770-121">www.wago.com/770-121</a>
	<b>Item no.: 770-131</b> Locking lever; for flying leads; for tool operation; white	<a href="http://www.wago.com/770-131">www.wago.com/770-131</a>

### Strain relief plate

	<b>Item no.: 770-503</b> Strain relief housing; 3-pole; for 2 cables; 8.0 ... 11.5 mm; 55 mm; black	<a href="http://www.wago.com/770-503">www.wago.com/770-503</a>
	<b>Item no.: 770-503/021-000</b> Strain relief housing; 3-pole; for 1 cable; 9.0 ... 13.0 mm; 71 mm; black	<a href="http://www.wago.com/770-503/021-000">www.wago.com/770-503/021-000</a>
	<b>Item no.: 770-503/023-000</b> Strain relief housing; 3-pole; for 2 cables; 4.5 ... 8.0 mm; 55 mm; black	<a href="http://www.wago.com/770-503/023-000">www.wago.com/770-503/023-000</a>

Subject to changes. Please also observe the further product documentation!



**Item no.: 770-503/032-000**

Strain relief housing; 3-pole; with locking clip; for 2 cables; 8.0 ... 11.5 mm; 55 mm; black

[www.wago.com/770-503/032-000](http://www.wago.com/770-503/032-000)



**Item no.: 770-503/035-000**

Strain relief housing; 3-pole; with locking clip; for 1 cable; 7.0 ... 11.5 mm; 48 mm; black

[www.wago.com/770-503/035-000](http://www.wago.com/770-503/035-000)



**Item no.: 770-503/038-000**

Strain relief housing; 3-pole; with locking clip; for 1 cable; 7.0 ... 11.5 mm; 48 mm; black

[www.wago.com/770-503/038-000](http://www.wago.com/770-503/038-000)

**Item no.: 770-513**

Strain relief housing; 3-pole; for 2 cables; 8.0 ... 11.5 mm; 55 mm; white

[www.wago.com/770-513](http://www.wago.com/770-513)



**Item no.: 770-513/021-000**

Strain relief housing; 3-pole; for 1 cable; 9.0 ... 13.0 mm; 71 mm; white

[www.wago.com/770-513/021-000](http://www.wago.com/770-513/021-000)

**Item no.: 770-513/023-000**

Strain relief housing; 3-pole; for 2 cables; 4.5 ... 8.0 mm; 55 mm; white

[www.wago.com/770-513/023-000](http://www.wago.com/770-513/023-000)



**Item no.: 770-513/032-000**

Strain relief housing; 3-pole; for 2 cables; 8.0 ... 11.5 mm; 55 mm; white

[www.wago.com/770-513/032-000](http://www.wago.com/770-513/032-000)



**Item no.: 770-513/035-000**

Strain relief housing; 3-pole; with locking clip; for 1 cable; 7.0 ... 11.5 mm; 48 mm; white

[www.wago.com/770-513/035-000](http://www.wago.com/770-513/035-000)



**Item no.: 770-513/038-000**

Strain relief housing; 3-pole; with locking clip; for 1 cable; 7.0 ... 11.5 mm; 48 mm; white

[www.wago.com/770-513/038-000](http://www.wago.com/770-513/038-000)

#### Marking accessories



**Item no.: 770-450**

Marker card; Plastic; white

[www.wago.com/770-450](http://www.wago.com/770-450)



**Item no.: 770-450/000-001**

Marker card; Plastic; white

[www.wago.com/770-450/000-001](http://www.wago.com/770-450/000-001)



**Item no.: 770-450/000-002**

Marker card; Plastic; white

[www.wago.com/770-450/000-002](http://www.wago.com/770-450/000-002)



**Item no.: 770-450/000-005**

Marker card; Plastic; white

[www.wago.com/770-450/000-005](http://www.wago.com/770-450/000-005)

Subject to changes. Please also observe the further product documentation!

WAGO Kontakttechnik GmbH & Co. KG

Hansastr. 27

32423 Minden

Phone: +49571 887-0 | Fax: +49571 887-169

Email: [info.de@wago.com](mailto:info.de@wago.com) | Web: [www.wago.com](http://www.wago.com)

Do you have any questions about our products?

We are always happy to take your call at +49 (571) 887-44222.



Item no.: 770-450/000-006  
Marker card; Plastic; white

[www.wago.com/770-450/000-006](http://www.wago.com/770-450/000-006)



Item no.: 770-450/000-012  
Marker card; Plastic; white

[www.wago.com/770-450/000-012](http://www.wago.com/770-450/000-012)

## Downloads

### CAD/CAE-Data

#### CAD data

2D/3D Models 770-283

[URL](#)

[Download](#)

#### CAE data

WSCAD Universe 770-283

[URL](#)

[Download](#)

## Installation Notes

### Conductor termination

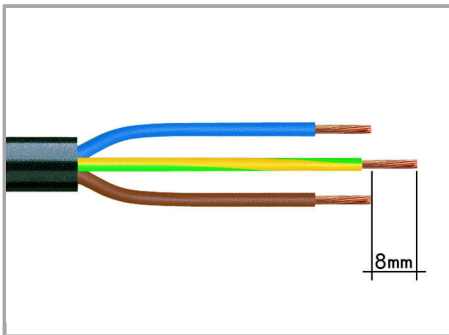

1. Strip length, outer insulation = 35 mm (2-pole), 55 mm (3- to 5-pole)

2. Strip length = 9 mm

3. Extended ground conductor = 8 mm

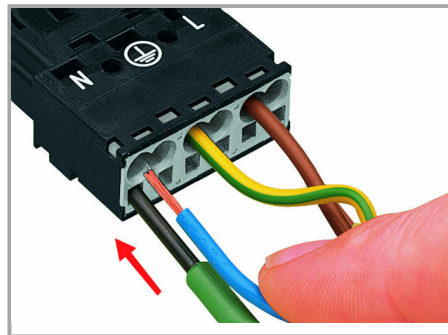

To terminate fine-stranded conductors, open the clamping unit via screwdriver (2.5 mm blade width) and insert stripped conductor until it hits backstop.

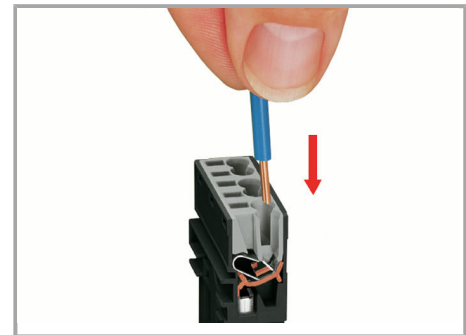

Insert stripped solid conductor until it hits backstop.

Subject to changes. Please also observe the further product documentation!



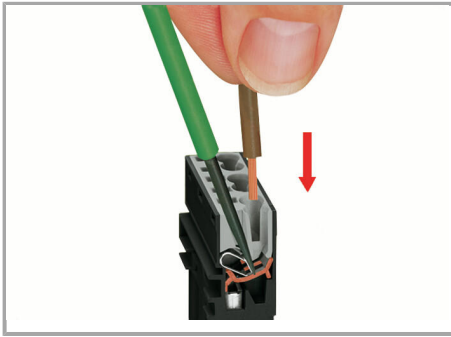

To terminate fine-stranded conductors, open the clamping unit via screwdriver (2.5 mm blade width) and insert stripped conductor until it hits backstop.

#### Conductor removal

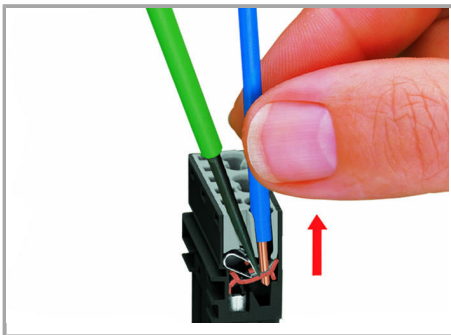

To remove the conductor, actuate the clamp via screwdriver (2.5 mm blade width) and pull out the conductor.

#### Installation

Subject to changes. Please also observe the further product documentation!

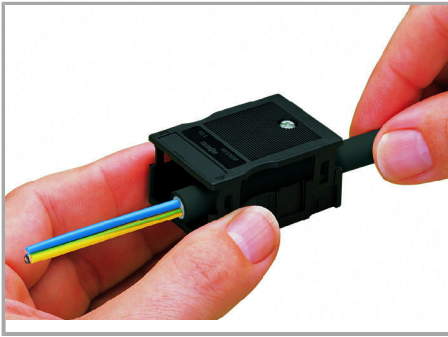

We recommend pulling the pre-latched strain relief housing over the cable prior to termination. However, the strain relief can be mounted at a later time as well.

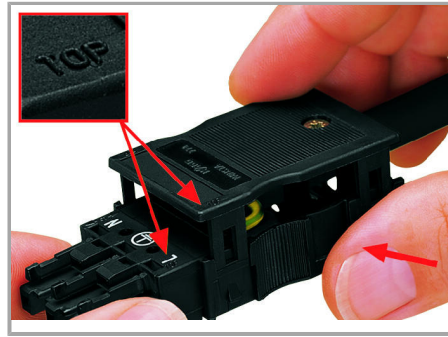

Latch the strain relief housing on the plug /socket. Note the "TOP" inscription.

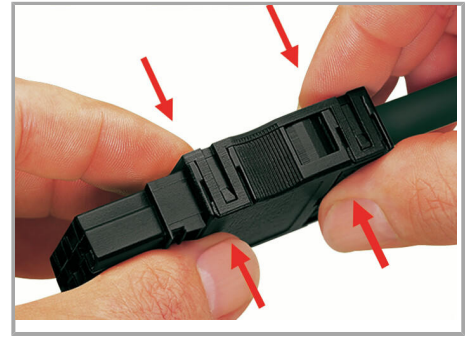

Prepare strain relief housing by snapping together upper and bottom part.



Tighten strain relief screw via screwdriver (2.5 mm blade width).

### Coding

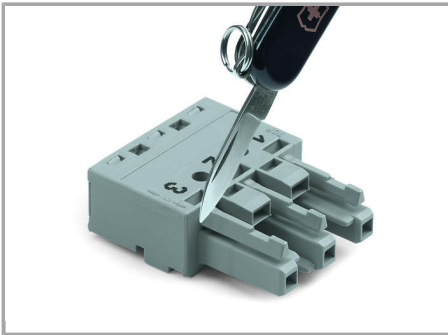

Simply cut off the coding pin from the socket.

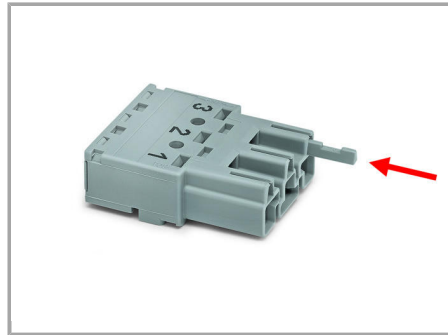

Insert coding pin into plug (break first) until it engages.

### Mismatching protection

Subject to changes. Please also observe the further product documentation!

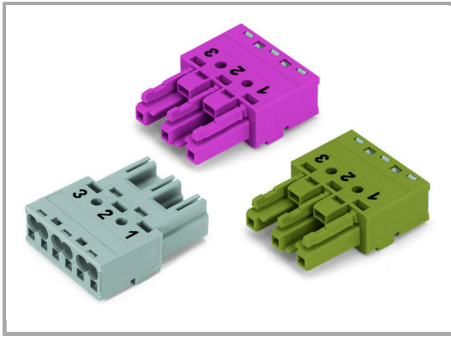

B-coded connectors with different colors can be plugged together.

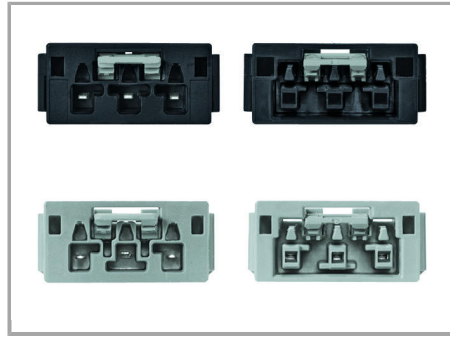

B-coded connectors (shown in gray) not only differ in color, but also in their design, making them incompatible with other coded connectors.

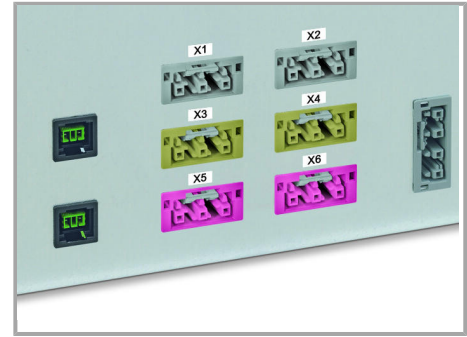

Easy circuit identification via different marking and colors

**Important note:**

Different colors and/or pole marking are used for circuit identification.

Only connectors of the same color and same pole marking must be plugged together.

**Product family**

**<i>WINSTA</i>® MIDI special**

[Show all products from the family](#)

Subject to changes. Please also observe the further product documentation!

WAGO Kontakttechnik GmbH & Co. KG  
Hansastr. 27  
32423 Minden  
Phone: +49571 887-0 | Fax: +49571 887-169  
Email: [info.de@wago.com](mailto:info.de@wago.com) | Web: [www.wago.com](http://www.wago.com)

Do you have any questions about our products?  
We are always happy to take your call at +49 (571) 887-44222.