

Item description

- Protected against mismatching and maintenance-free
- Push-in CAGE CLAMP® spring pressure connection technology allows solid conductors to be simply pushed into a unit
- Two-wire connection per pole for loops or bridges
- Additional variable coding is possible
- Components can be clearly printed on and color-coded to meet custom requirements

Note:

All connectors for mounted installations (snap-in versions for lighting fixtures or devices, all types of PCB and distribution connectors) are factory-equipped with locking levers to ensure plugs and sockets are securely locked. Additional locking levers are only required for flying leads (plug /socket).

Note on mismatching protection:

All WINSTA® components are 100% protected against mismatching when:

- a.) plugging different numbers of poles
- b.) plugging while rotated 180
- c.) plugging while laterally staggered

Subject to changes. Please also observe the further product documentation!



d.) plugging one pole

Safety information 1:

Application note for the U.S. market (USR): Some versions may also be used for current interruption in accordance with the UL certificate in select applications with currents below 16 A and voltages up to 600 V. For further information, please contact your local sales office.

Data

Electrical data

Note on Contact Resistance	approx. 1 mΩ of contact resistance approx. 0.25 mΩ contact transition plug/socket
----------------------------	---

Ratings per IEC/EN 60664-1

Ratings per	IEC/EN 60664-1
Rated voltage (III / 3)	250 V
Rated impulse voltage (III / 3)	4 kV
Rated current	25 A
Legend (ratings)	(III / 3) ≙ Overvoltage category III / Pollution degree 3

Approvals per UL 1977

Rated voltage per UL 1977 (factory wiring only)	600 V
Rated current per UL 1977 (factory wiring only)	23 A

Connection data

Connection technology	Push-in CAGE CLAMP®
Actuation type	Operating tool Push-in
Nominal cross section	4 mm ²
Solid conductor	0,5 ... 4 mm ² / 20 ... 12 AWG
Solid conductor, push-in termination	1,5 ... 4 mm ² / 16 ... 12 AWG
Stranded conductor	0,5 ... 2,5 mm ² / 20 ... 14 AWG
Fine-stranded conductor	0,5 ... 4 mm ² / 20 ... 12 AWG
Fine-stranded conductor with ferrule with plastic collar	0,25 ... 1,5 mm ² / 20 ... 16 AWG
Fine-stranded conductor with ferrule without plastic collar	0,25 ... 2,5 mm ² / 20 ... 14 AWG
Fine-stranded conductor with ferrule, push-in termination, from	1,5 mm ² / 16 AWG
Strip length	9 mm / 0.35 inch
Note (strip length)	see also packaging or instructions
No. of poles	3
Total number of connection points	6

Subject to changes. Please also observe the further product documentation!



Total number of potentials	3
Conductor entry direction to mating direction	0°

Geometrical Data

Pin spacing	10 mm / 0.394 inch
Width	30 mm / 1.181 inch
Height	12,9 mm / 0.508 inch
Depth	37,5 mm / 1.476 inch

Mechanical data

Coding	B
Mating force of a plug-in connection	approx. 20 ... 70 N (depending on pole number)
Retention force of a plug-in connection	Locked: > 80 N
Unmating force of a plug-in connection	Unlocked: approx. 20 ... 70 N (depending on pole number)
Number of mating cycles	200, without resistive load 100, with resistive load $I_N = 25$ A, tested (4 mm ² /AWG 12)
Marking	1 2
Protection class	IP20
Note on protection class	In mated condition with strain relief housing: IP2xC (These compact connectors are not designed for use in open, easily accessible areas.)
Potential marking	1 2

Plug connection

Contact type (pluggable connector)	Male connector/plug
Connector connection type	for conductor
Mismating protection	Yes
Locking of plug-in connection	locking lever
Locking lever	retrofitable

Material Data

Color	light green
Insulating material	Polyamide 66 (PA 66)
Clamping spring material	Chrome nickel spring steel (CrNi)

Subject to changes. Please also observe the further product documentation!

Contact material	Copper or copper alloy (surface-treated)
Fire load	0.196 MJ
Weight	10 g

Environmental Requirements

Processing temperature	-5 ... +40 °C
Continuous operating temperature	-35 ... +85 °C
Note on Continuous Service Temperature	Insulating parts for temperatures ≤ 105 °C

Commercial data

Packaging type	BOX
Country of origin	DE
GTIN	4050821553403
Customs Tariff No.	85366990990

Approvals / Certificates

UL-Approvals







Logo	Approval	Additional Approval Text	Certificate name
	cURus Underwriters Laboratories Inc.	UL 1977	E45171 Sec. 9

Counterpart

	Item no.770-263/073-000 Socket; 3-pole; Cod. B; 4,00 mm ² ; light green	www.wago.com/770-263/073-000
	Item no.770-763/073-000 Snap-in socket; 3-pole; Cod. B; 4,00 mm ² ; light green	www.wago.com/770-763/073-000
	Item no.770-863/011-000/073-000 Socket for PCBs; angled; 3-pole; Cod. B; light green	www.wago.com/770-863/011-000/073-000
	Item no.770-863/073-000 Socket for PCBs; straight; 3-pole; Cod. B; light green	www.wago.com/770-863/073-000

Subject to changes. Please also observe the further product documentation!

Compatible products

Coding		
	Item no.: 770-401 Coding pin; for plugs; Plastic; gray	www.wago.com/770-401
protection		
	Item no.: 770-360 Lockout cap; for plugs; 5-pole; separable; yellow	www.wago.com/770-360
Strain relief plate		
	Item no.: 770-503 Strain relief housing; 3-pole; for 2 cables; 8.0 ... 11.5 mm; 55 mm; black	www.wago.com/770-503
	Item no.: 770-503/021-000 Strain relief housing; 3-pole; for 1 cable; 9.0 ... 13.0 mm; 71 mm; black	www.wago.com/770-503/021-000
	Item no.: 770-503/023-000 Strain relief housing; 3-pole; for 2 cables; 4.5 ... 8.0 mm; 55 mm; black	www.wago.com/770-503/023-000
	Item no.: 770-503/032-000 Strain relief housing; 3-pole; with locking clip; for 2 cables; 8.0 ... 11.5 mm; 55 mm; black	www.wago.com/770-503/032-000
	Item no.: 770-503/035-000 Strain relief housing; 3-pole; with locking clip; for 1 cable; 7.0 ... 11.5 mm; 48 mm; black	www.wago.com/770-503/035-000
	Item no.: 770-503/038-000 Strain relief housing; 3-pole; with locking clip; for 1 cable; 7.0 ... 11.5 mm; 48 mm; black	www.wago.com/770-503/038-000
	Item no.: 770-513 Strain relief housing; 3-pole; for 2 cables; 8.0 ... 11.5 mm; 55 mm; white	www.wago.com/770-513
	Item no.: 770-513/021-000 Strain relief housing; 3-pole; for 1 cable; 9.0 ... 13.0 mm; 71 mm; white	www.wago.com/770-513/021-000
	Item no.: 770-513/023-000 Strain relief housing; 3-pole; for 2 cables; 4.5 ... 8.0 mm; 55 mm; white	www.wago.com/770-513/023-000

Subject to changes. Please also observe the further product documentation!



Item no.: 770-513/032-000
Strain relief housing; 3-pole; for 2 cables; 8.0 ... 11.5 mm; 55 mm; white

www.wago.com/770-513/032-000



Item no.: 770-513/035-000
Strain relief housing; 3-pole; with locking clip; for 1 cable; 7.0 ... 11.5 mm; 48 mm; white

www.wago.com/770-513/035-000



Item no.: 770-513/038-000
Strain relief housing; 3-pole; with locking clip; for 1 cable; 7.0 ... 11.5 mm; 48 mm; white

www.wago.com/770-513/038-000

Locking lever

Item no.: 770-101
Locking lever; for flying leads; for manual operation; black

www.wago.com/770-101

Item no.: 770-111
Locking lever; for flying leads; for tool operation; black

www.wago.com/770-111



Item no.: 770-121
Locking lever; for flying leads; for manual operation; white

www.wago.com/770-121

Item no.: 770-131
Locking lever; for flying leads; for tool operation; white

www.wago.com/770-131

tools

Item no.: 210-719
Operating tool; Blade: 2.5 x 0.4 mm; with a partially insulated shaft

www.wago.com/210-719



Item no.: 770-383
Operating tool; 3-way; green

www.wago.com/770-383

Marking accessories



Item no.: 770-450
Marker card; Plastic; white

www.wago.com/770-450



Item no.: 770-450/000-001
Marker card; Plastic; white

www.wago.com/770-450/000-001



Item no.: 770-450/000-002
Marker card; Plastic; white

www.wago.com/770-450/000-002



Item no.: 770-450/000-005
Marker card; Plastic; white

www.wago.com/770-450/000-005

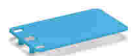

Item no.: 770-450/000-006
Marker card; Plastic; white

www.wago.com/770-450/000-006

Subject to changes. Please also observe the further product documentation!



Item no.: 770-450/000-012
Marker card; Plastic; white

www.wago.com/770-450/000-012

Downloads

CAD/CAE-Data

CAD data

2D/3D Models 770-273/073-000

URL

Download

CAE data

WSCAD Universe 770-273/073-000

URL

Download

Installation Notes

Conductor termination

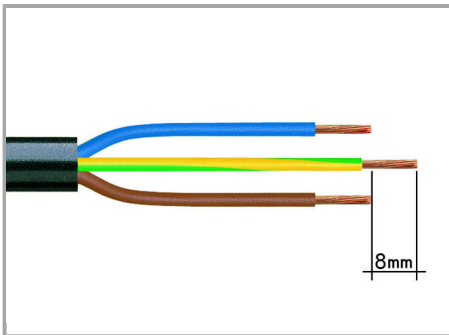

1. Strip length, outer insulation = 35 mm (2-pole), 55 mm (3- to 5-pole)

2. Strip length = 9 mm

3. Extended ground conductor = 8 mm

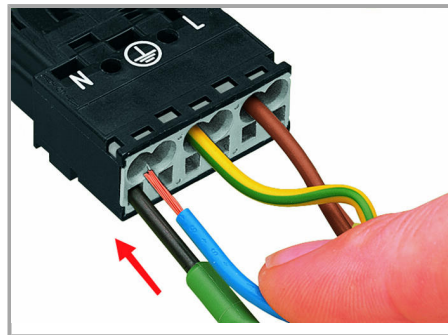

To terminate fine-stranded conductors, open the clamping unit via screwdriver (2.5 mm blade width) and insert stripped conductor until it hits backstop.

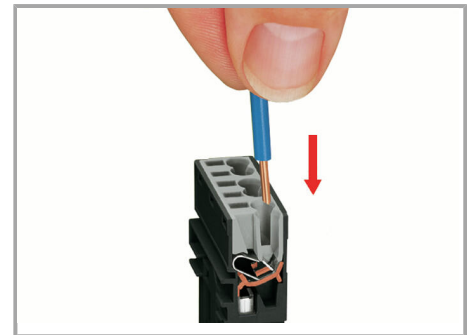

Insert stripped solid conductor until it hits backstop.

Subject to changes. Please also observe the further product documentation!

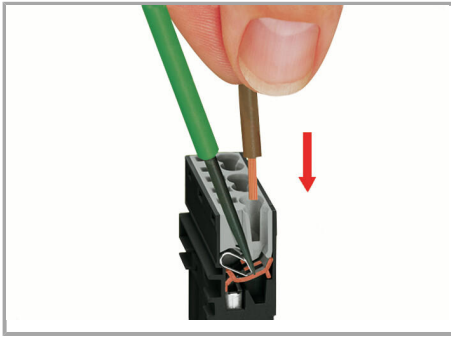

To terminate fine-stranded conductors, open the clamping unit via screwdriver (2.5 mm blade width) and insert stripped conductor until it hits backstop.

Conductor removal

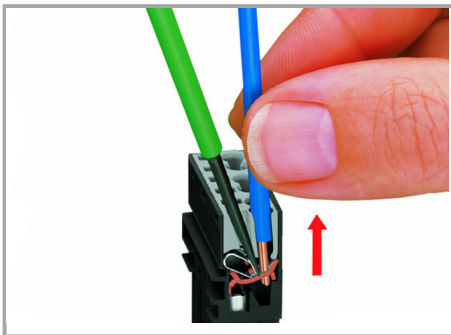

To remove the conductor, actuate the clamp via screwdriver (2.5 mm blade width) and pull out the conductor.

Installation

Subject to changes. Please also observe the further product documentation!

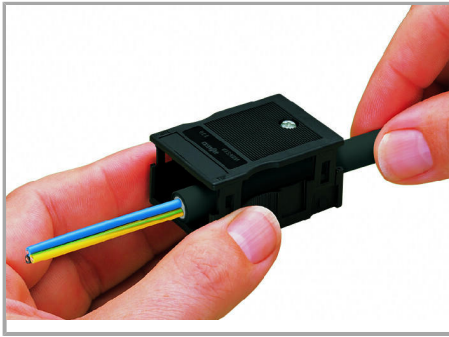

We recommend pulling the pre-latched strain relief housing over the cable prior to termination. However, the strain relief can be mounted at a later time as well.

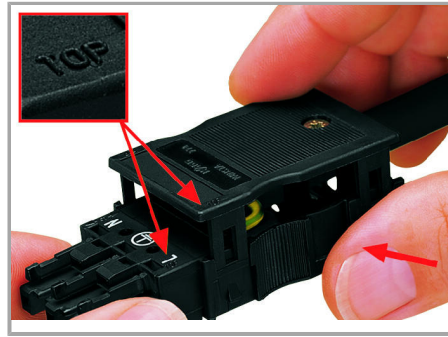

Latch the strain relief housing on the plug /socket. Note the "TOP" inscription.

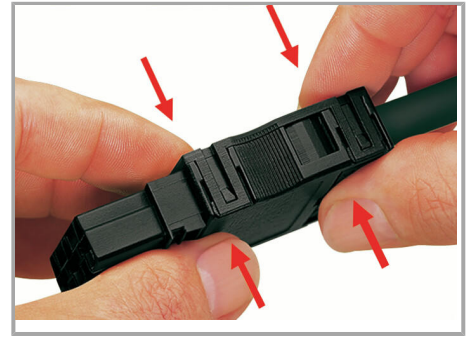

Prepare strain relief housing by snapping together upper and bottom part.



Tighten strain relief screw via screwdriver (2.5 mm blade width).

Coding



Simply cut off the coding pin from the socket.

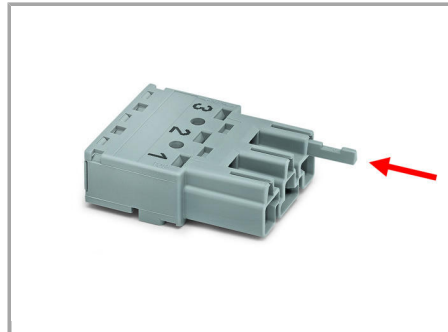

Insert coding pin into plug (break first) until it engages.

Mismatching protection

Subject to changes. Please also observe the further product documentation!

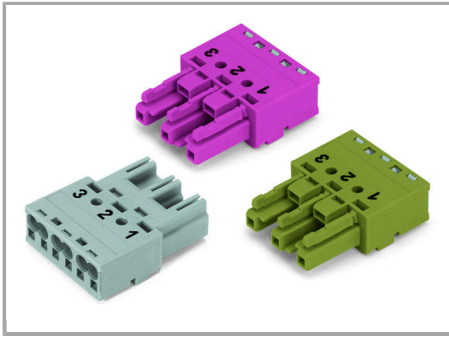

B-coded connectors with different colors can be plugged together.

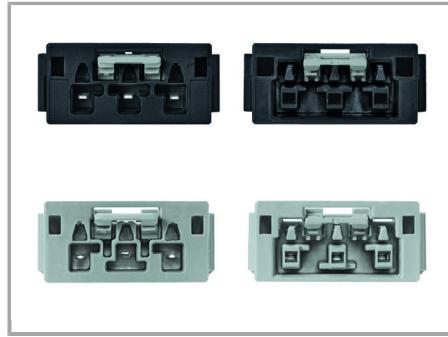

B-coded connectors (shown in gray) not only differ in color, but also in their design, making them incompatible with other coded connectors.

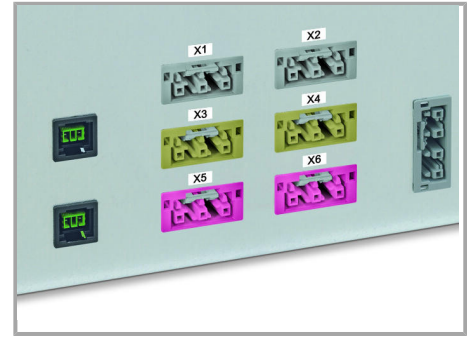

Easy circuit identification via different marking and colors

Important note:

Different colors and/or pole marking are used for circuit identification.

Only connectors of the same color and same pole marking must be plugged together.

Product family

[*<i>WINSTA</i>*](#)® MIDI special

[Show all products from the family](#)

Subject to changes. Please also observe the further product documentation!