

## Data sheet | Item number: 770-1653

h-distribution connector; 2-pole; Cod. B; 1 input; 2 outputs; outputs on one side; 2 locking levers; pink

[www.wago.com/770-1653](http://www.wago.com/770-1653)

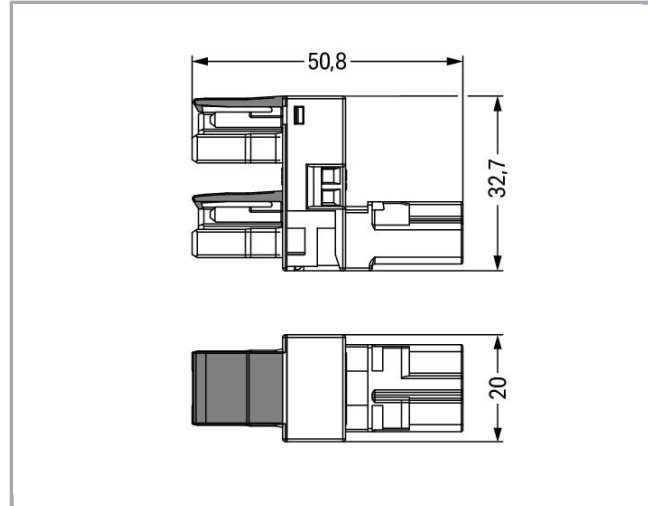

### Item description

- Protected against mismatching and maintenance-free
- Components can be clearly printed on and color-coded to meet custom requirements

#### Note:

All connectors for mounted installations (snap-in versions for lighting fixtures or devices, all types of PCB and distribution connectors) are factory-equipped with locking levers to ensure plugs and sockets are securely locked. Additional locking levers are only required for flying leads (plug /socket).

#### Note on mismatching protection:

All WINSTA<sup>®</sup> components are 100% protected against mismatching when:

Subject to changes. Please also observe the further product documentation!

WAGO Kontakttechnik GmbH & Co. KG  
Hansastr. 27  
32423 Minden  
Phone: +49571 887-0 | Fax: +49571 887-169  
Email: [info.de@wago.com](mailto:info.de@wago.com) | Web: [www.wago.com](http://www.wago.com)

Do you have any questions about our products?  
We are always happy to take your call at +49 (571) 887-44222.



- a.) plugging different numbers of poles
- b.) plugging while rotated 180
- c.) plugging while laterally staggered
- d.) plugging one pole

**Safety information 1:**

Application note for the U.S. market (USR): Some versions may also be used for current interruption in accordance with the UL certificate in select applications with currents below 16 A and voltages up to 600 V. For further information, please contact your local sales office.

**Data****Electrical data**

Note on Contact Resistance	approx. 1 mΩ of contact resistance approx. 0.25 mΩ contact transition plug/socket
----------------------------	---

**Ratings per IEC/EN 60664-1**

Ratings per	IEC/EN 60664-1
Rated voltage (III / 3)	250 V
Rated impulse voltage (III / 3)	4 kV
Rated current	25 A
Legend (ratings)	(III / 3) ≙ Overvoltage category III / Pollution degree 3

**Approvals per UL 1977**

Rated voltage per UL 1977 (factory wiring only)	600 V
Rated current per UL 1977 (factory wiring only)	23 A

**Connection data**

No. of poles	2
Total number of potentials	2

**Geometrical Data**

Pin spacing	10 mm / 0.394 inch
Width	20 mm / 0.787 inch
Height	32,7 mm / 1.287 inch
Depth	51 mm / 2.008 inch

**Mechanical data**

Coding	B
Mating force of a plug-in connection	approx. 20 ... 70 N (depending on pole number)

Subject to changes. Please also observe the further product documentation!



Retention force of a plug-in connection	When locked: > 80 N
Unmating force of a plug-in connection	when unlocked: approx. 20 ... 70 N (depending on pole number)
Number of mating cycles	200, without resistive load 100, with resistive load $I_N = 25$ A, tested (4 mm <sup>2</sup> /AWG 12)
Type of distribution connector	h-distribution connector (unidirectional)
Marking	1 2
Protection class	IP20
Note on protection class	Only when mated (these compact connectors are not designed for use in open, easily accessible areas).
Potential marking	1 2

### Plug connection

Contact type (pluggable connector)	Socket/plug
Mismating protection	Yes
Locking of plug-in connection	locking lever
Locking lever	yes

### Material Data

Color	pink
Insulating material	Polyamide 66 (PA 66)
Contact material	Copper or copper alloy (surface-treated)
Fire load	0.259 MJ
Weight	15.2 g

### Environmental Requirements

Processing temperature	-5 ... +40 °C
Continuous operating temperature	-35 ... +85 °C
Note on Continuous Service Temperature	Insulating parts for temperatures $\leq 105$ °C

### Commercial data

Product Group	20 (WINSTA)
Packaging type	BOX
Country of origin	DE
GTIN	4050821531210
Customs Tariff No.	85366990990

### Approvals / Certificates

Subject to changes. Please also observe the further product documentation!





WAGO Kontakttechnik GmbH & Co. KG  
 Hansastr. 27  
 32423 Minden  
 Phone: +49571 887-0 | Fax: +49571 887-169  
 Email: [info.de@wago.com](mailto:info.de@wago.com) | Web: [www.wago.com](http://www.wago.com)

Do you have any questions about our products?  
 We are always happy to take your call at +49 (571) 887-44222.

## UL-Approvals



Logo	Approval	Additional Approval Text	Certificate name
	cURus Underwriters Laboratories Inc.	UL 1977	E45171 Sec. 9

## Counterpart

	<b>Item no.770-292</b> Plug; 2-pole; Cod. B; 4,00 mm <sup>2</sup> ; pink	<a href="http://www.wago.com/770-292">www.wago.com/770-292</a>
	<b>Item no.770-282</b> Socket; 2-pole; Cod. B; 4,00 mm <sup>2</sup> ; pink	<a href="http://www.wago.com/770-282">www.wago.com/770-282</a>
	<b>Item no.771-8992/005-107</b> pre-assembled interconnecting cable; Eca; Socket/plug; 2-pole; Cod. B; Control cable 2 x 1.0 mm <sup>2</sup> ; 1 m; 1,00 mm <sup>2</sup> ; pink	<a href="http://www.wago.com/771-8992/005-107">www.wago.com/771-8992/005-107</a>
	<b>Item no.771-8992/105-107</b> pre-assembled connecting cable; Socket/open-ended; 2-pole; Cod. B; Control cable 2 x 1.0 mm <sup>2</sup> ; 1 m; 1,00 mm <sup>2</sup> ; pink	<a href="http://www.wago.com/771-8992/105-107">www.wago.com/771-8992/105-107</a>
	<b>Item no.771-8992/205-107</b> pre-assembled connecting cable; Eca; Plug/open-ended; 2-pole; Cod. B; Control cable 2 x 1.0 mm <sup>2</sup> ; 1 m; 1,00 mm <sup>2</sup> ; pink	<a href="http://www.wago.com/771-8992/205-107">www.wago.com/771-8992/205-107</a>

## Compatible products

## protection

	<b>Item no.: 770-201</b> Lockout cap; 12-pole, separable; 12-pole; for sockets; black	<a href="http://www.wago.com/770-201">www.wago.com/770-201</a>
	<b>Item no.: 770-221</b> Lockout cap; for socket; 12-pole; separable; white	<a href="http://www.wago.com/770-221">www.wago.com/770-221</a>
	<b>Item no.: 770-360</b> Lockout cap; for plugs; 5-pole; separable; yellow	<a href="http://www.wago.com/770-360">www.wago.com/770-360</a>

## assembling

	<b>Item no.: 770-1626</b> Mounting plate; 2-pole; for distribution connectors; Plastic; black	<a href="http://www.wago.com/770-1626">www.wago.com/770-1626</a>
	<b>Item no.: 770-1627</b> Mounting plate; 2-pole; for distribution connectors; Plastic; white	<a href="http://www.wago.com/770-1627">www.wago.com/770-1627</a>

Subject to changes. Please also observe the further product documentation!

## Downloads

### CAD/CAE-Data

#### CAE data

WSCAD Universe 770-1653

URL

Download

## Installation Notes

### Installation

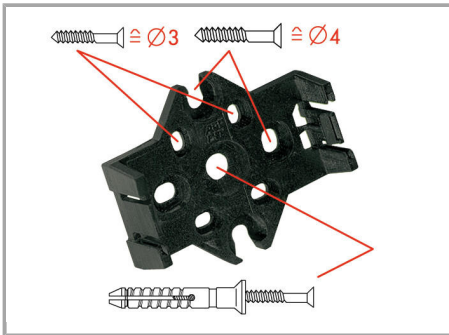

The mounting plate for distribution connectors can be mounted using commercially available screws or nail-drive anchors.



The distribution connectors are latched when mounted on the mounting plate.



To release the distribution connector, unlock the latch using a screwdriver.

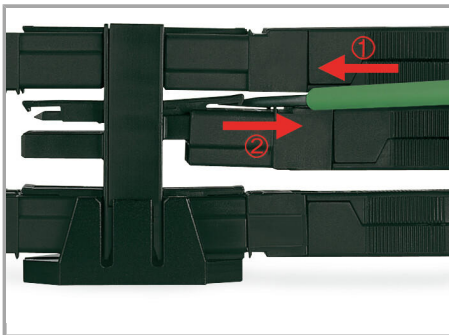

All distributor connections are locked and protected against accidental disconnection directly after mating. Locking of any connection is released using a screwdriver, even if all connections are in use.

## Product family

Subject to changes. Please also observe the further product documentation!



*WINSTA*® MIDI special

Show all products from the family

Subject to changes. Please also observe the further product documentation!

---

WAGO Kontakttechnik GmbH & Co. KG  
Hansastr. 27  
32423 Minden  
Phone: +49571 887-0 | Fax: +49571 887-169  
Email: [info.de@wago.com](mailto:info.de@wago.com) | Web: [www.wago.com](http://www.wago.com)

Do you have any questions about our products?  
We are always happy to take your call at +49 (571) 887-44222.