

Data sheet | Item number: 770-1335

Plug; 5-pole; Cod. Q; 4,00 mm²; green

www.wago.com/770-1335

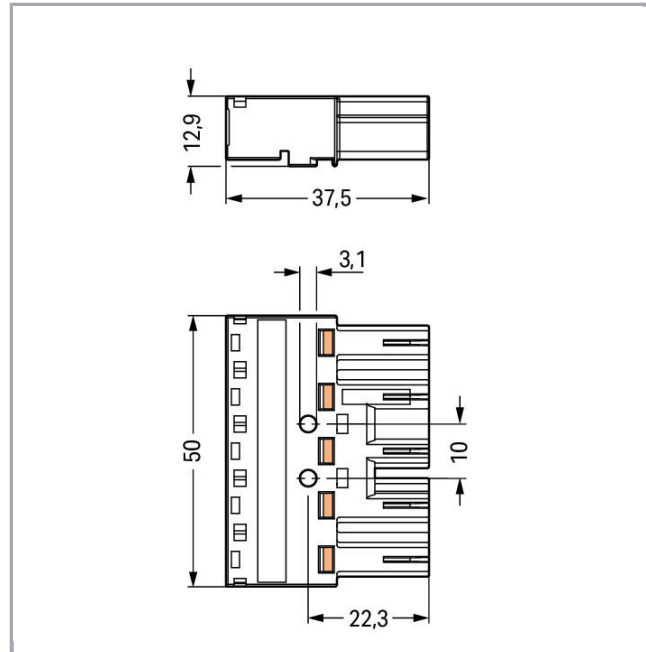
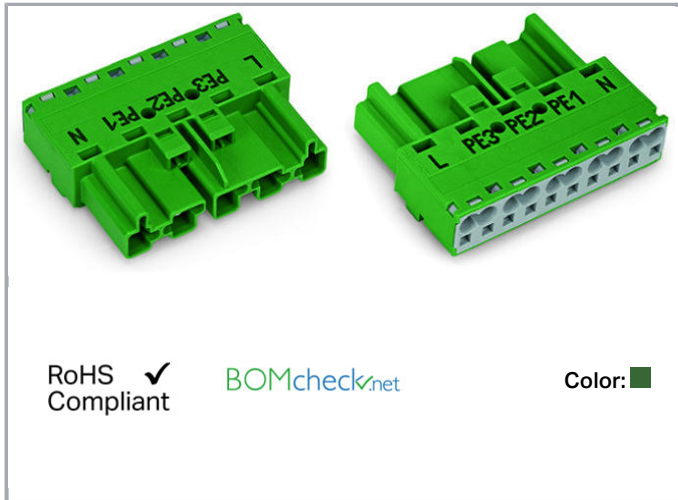

Item description

- Protected against mismatching and maintenance-free
- Push-in CAGE CLAMP® spring pressure connection technology allows solid conductors to be simply pushed into a unit
- Two-wire connection per pole for loops or bridges
- Additional variable coding is possible

Note:

All connectors for mounted installations (snap-in versions for lighting fixtures or devices, all types of PCB and distribution connectors) are factory-equipped with locking levers to ensure plugs and sockets are securely locked. Additional locking levers are only required for flying leads (plug /socket).

Note on mismatching protection:

All WINSTA® components are 100% protected against mismatching when:

- a.) plugging different numbers of poles
- b.) plugging while rotated 180
- c.) plugging while laterally staggered
- d.) plugging one pole

Subject to changes. Please also observe the further product documentation!

WAGO Kontakttechnik GmbH & Co. KG
Hansastr. 27
32423 Minden
Phone: +49571 887-0 | Fax: +49571 887-169
Email: info.de@wago.com | Web: www.wago.com

Do you have any questions about our products?
We are always happy to take your call at +49 (571) 887-44222.

**Safety information 1:**

Application note for the U.S. market (USR): Some versions may also be used for current interruption in accordance with the UL certificate in select applications with currents below 16 A and voltages up to 600 V. For further information, please contact your local sales office.

Data**Electrical data**

Note on Contact Resistance	approx. 1 mΩ of contact resistance approx. 0.25 mΩ contact transition plug/socket
----------------------------	---

Ratings per IEC/EN 60664-1

Ratings per	IEC/EN 60664-1
Rated voltage (III / 3)	400 V
Rated impulse voltage (III / 3)	6 kV
Rated current	32 A
Legend (ratings)	(III / 3) ≙ Overvoltage category III / Pollution degree 3

Approvals per UL 1977

Rated voltage per UL 1977 (factory wiring only)	600 V
Rated current per UL 1977 (factory wiring only)	23 A

Connection data

Connection technology	Push-in CAGE CLAMP®
Actuation type	Operating tool Push-in
Nominal cross section	4 mm ²
Solid conductor	0,5 ... 4 mm ² / 20 ... 12 AWG
Solid conductor, push-in termination	1,5 ... 4 mm ² / 16 ... 12 AWG
Stranded conductor	0,5 ... 2,5 mm ² / 20 ... 14 AWG
Fine-stranded conductor	0,5 ... 4 mm ² / 20 ... 12 AWG
Fine-stranded conductor with ferrule with plastic collar	0,25 ... 1,5 mm ² / 20 ... 16 AWG
Fine-stranded conductor with ferrule without plastic collar	0,25 ... 2,5 mm ² / 20 ... 14 AWG
Fine-stranded conductor with ferrule, push-in termination, from	1,5 mm ² / 16 AWG
Strip length	9 mm / 0.35 inch
Note (strip length)	see also packaging or instructions
No. of poles	5
Total number of connection points	5
Total number of potentials	5

Subject to changes. Please also observe the further product documentation!



Conductor entry direction to mating direction	0°
---	----

Geometrical Data

Pin spacing	10 mm / 0.394 inch
Width	50 mm / 1.969 inch
Height	12,9 mm / 0.508 inch
Depth	37,5 mm / 1.476 inch

Mechanical data

Coding	Q
Mating force of a plug-in connection	approx. 20 ... 70 N (depending on pole number)
Retention force of a plug-in connection	Locked: > 80 N
Unmating force of a plug-in connection	Unlocked: approx. 20 ... 70 N (depending on pole number)
Number of mating cycles	200, without resistive load 100, with resistive load $I_N = 25$ A, tested (4 mm ² /AWG 12)
Marking	N PE1 PE2 PE3 L
Protection class	IP20
Note on protection class	In mated condition with strain relief housing: IP2xC (These compact connectors are not designed for use in open, easily accessible areas.)
Potential marking	N PE1 PE2 PE3 L
Application	for "Clean Ground" applications

Plug connection

Contact type (pluggable connector)	Male connector/plug
Connector connection type	for conductor
Mismating protection	Yes
Locking of plug-in connection	locking lever
Locking lever	retrofitable

Material Data

Color	green
Insulating material	Polyamide 66 (PA 66)
Clamping spring material	Chrome nickel spring steel (CrNi)

Subject to changes. Please also observe the further product documentation!

Contact material	Copper or copper alloy (surface-treated)
Fire load	0.31 MJ
Weight	16.1 g

Environmental Requirements

Processing temperature	-5 ... +40 °C
Continuous operating temperature	-35 ... +85 °C
Note on Continuous Service Temperature	Insulating parts for temperatures ≤ 105 °C

Commercial data



Packaging type	BOX
Country of origin	DE
GTIN	4045454071653
Customs Tariff No.	85366990990

Approvals / Certificates

Country specific Approvals

Logo	Approval	Additional Approval Text	Certificate name
	CCA DEKRA Certification B.V.	EN 61535	2173495.02
	CCA DEKRA Certification B.V.	IEC 61535	NL-32105

Ship Approvals

Logo	Approval	Additional Approval Text	Certificate name
	ABS American Bureau of Shipping	-	19- HG1868589- PDA
	DNV GL Det Norske Veritas, Germanischer Lloyd	-	TAE00001Z6
	LR Lloyds Register	IEC 61984	02/20050 (E6)

Subject to changes. Please also observe the further product documentation!

UL-Approvals

Logo	Approval	Additional Approval Text	Certificate name
	cURus Underwriters Laboratories Inc.	UL 1977	E45171 Sec. 9

Counterpart





	Item no.770-1325 Socket; 5-pole; Cod. Q; 4,00 mm ² ; green	www.wago.com/770-1325
	Item no.770-2325 Snap-in socket; 5-pole; Cod. Q; 4,00 mm ² ; green	www.wago.com/770-2325

Compatible products



Coding

	Item no.: 770-401 Coding pin; for plugs; Plastic; gray	www.wago.com/770-401
--	---	--

Locking lever

	Item no.: 770-101 Locking lever; for flying leads; for manual operation; black	www.wago.com/770-101
	Item no.: 770-111 Locking lever; for flying leads; for tool operation; black	www.wago.com/770-111
	Item no.: 770-121 Locking lever; for flying leads; for manual operation; white	www.wago.com/770-121
	Item no.: 770-131 Locking lever; for flying leads; for tool operation; white	www.wago.com/770-131

Marking accessories

	Item no.: 770-450 Marker card; Plastic; white	www.wago.com/770-450
	Item no.: 770-450/000-001 Marker card; Plastic; white	www.wago.com/770-450/000-001

Subject to changes. Please also observe the further product documentation!



Item no.: 770-450/000-002
Marker card; Plastic; white

www.wago.com/770-450/000-002



Item no.: 770-450/000-005
Marker card; Plastic; white

www.wago.com/770-450/000-005

Item no.: 770-450/000-006
Marker card; Plastic; white

www.wago.com/770-450/000-006



Item no.: 770-450/000-012
Marker card; Plastic; white

www.wago.com/770-450/000-012

Strain relief plate



Item no.: 770-505
Strain relief housing; 5-pole; for 2 cables; 9.0 ... 13.0 mm; 55 mm; black

www.wago.com/770-505



Item no.: 770-505/021-000
Strain relief housing; 5-pole; for 1 cable; 11.5 ... 16.5 mm; 71 mm; black

www.wago.com/770-505/021-000



Item no.: 770-505/023-000
Strain relief housing; 5-pole; for 2 cables; 5.0 ... 9.0 mm; 55 mm; black

www.wago.com/770-505/023-000



Item no.: 770-515
Strain relief housing; 5-pole; for 2 cables; 9.0 ... 13.0 mm; 55 mm; white

www.wago.com/770-515



Item no.: 770-515/021-000
Strain relief housing; 5-pole; for 1 cable; 11.5 ... 16.5 mm; 71 mm; white

www.wago.com/770-515/021-000



Item no.: 770-515/023-000
Strain relief housing; 5-pole; for 2 cables; 5.0 ... 9.0 mm; 55 mm; white

www.wago.com/770-515/023-000

tools



Item no.: 210-719
Operating tool; Blade: 2.5 x 0.4 mm; with a partially insulated shaft

www.wago.com/210-719



Item no.: 770-100
Wiring aid; for solid and stranded conductors; orange

www.wago.com/770-100

protection



Item no.: 770-360
Lockout cap; for plugs; 5-pole; separable; yellow

www.wago.com/770-360

Subject to changes. Please also observe the further product documentation!

Downloads

CAD/CAE-Data

CAD data

2D/3D Models 770-1335

[URL](#)

[Download](#)

CAE data

EPLAN Data Portal 770-1335

[URL](#)

[Download](#)

WSCAD Universe 770-1335

[URL](#)

[Download](#)

Installation Notes

Conductor termination

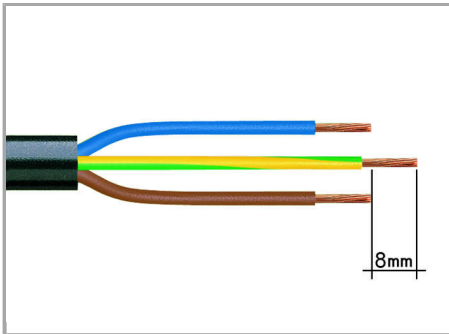

1. Strip length, outer insulation = 35 mm (2-pole), 55 mm (3- to 5-pole)

2. Strip length = 9 mm

3. Extended ground conductor = 8 mm

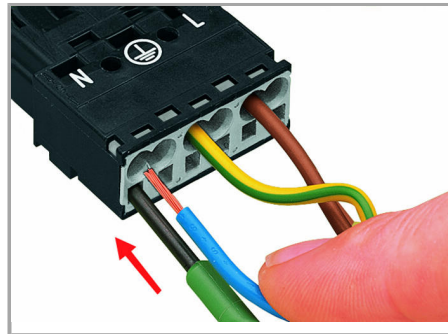

To terminate fine-stranded conductors, open the clamping unit via screwdriver (2.5 mm blade width) and insert stripped conductor until it hits backstop.

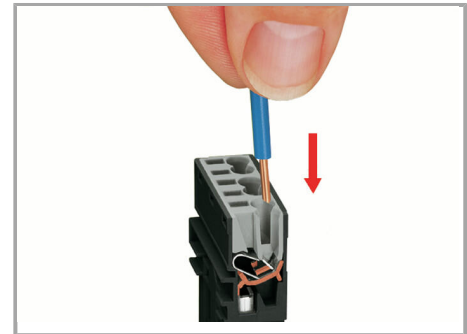

Insert stripped solid conductor until it hits backstop.

Subject to changes. Please also observe the further product documentation!

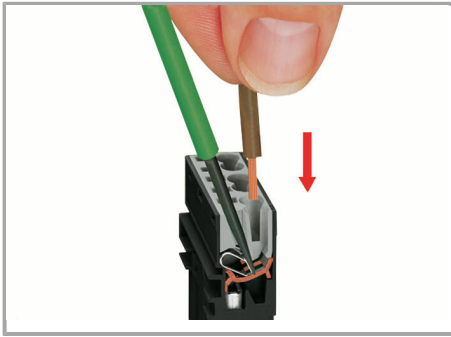

To terminate fine-stranded conductors, open the clamping unit via screwdriver (2.5 mm blade width) and insert stripped conductor until it hits backstop.

Conductor removal

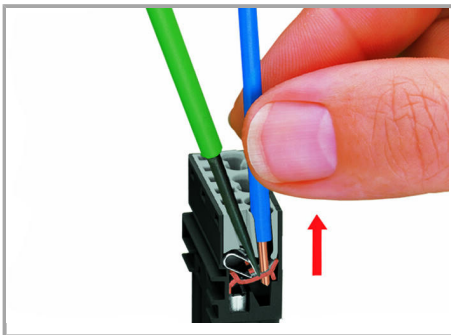

To remove the conductor, actuate the clamp via screwdriver (2.5 mm blade width) and pull out the conductor.

Installation

Subject to changes. Please also observe the further product documentation!

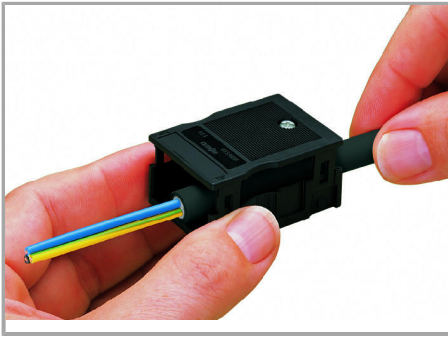

We recommend pulling the pre-latched strain relief housing over the cable prior to termination. However, the strain relief can be mounted at a later time as well.

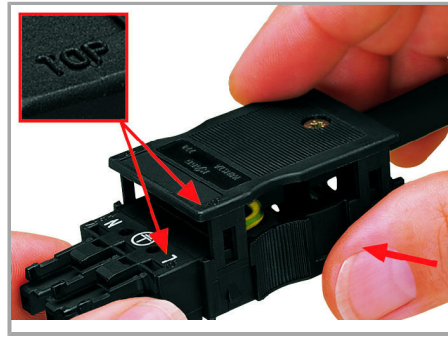

Latch the strain relief housing on the plug /socket. Note the "TOP" inscription.

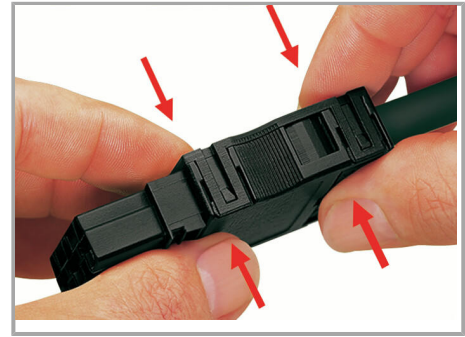

Prepare strain relief housing by snapping together upper and bottom part.



Tighten strain relief screw via screwdriver (2.5 mm blade width).

Product family

WINSTA® MIDI

[Show all products from the family](#)

Subject to changes. Please also observe the further product documentation!