

Data sheet | Item number: 769-670/004-000

THT male header; 1.0 x 1.0 mm solder pin; angled; Pin spacing 5 mm; 10-pole; gray

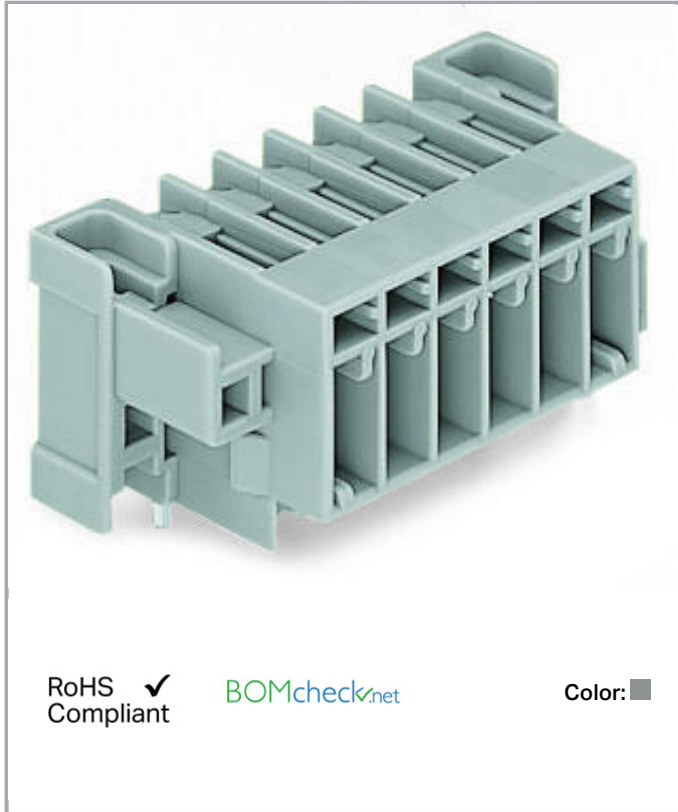

www.wago.com/769-670/004-000



RoHS Compliant

BOMcheck.net

Color: ■

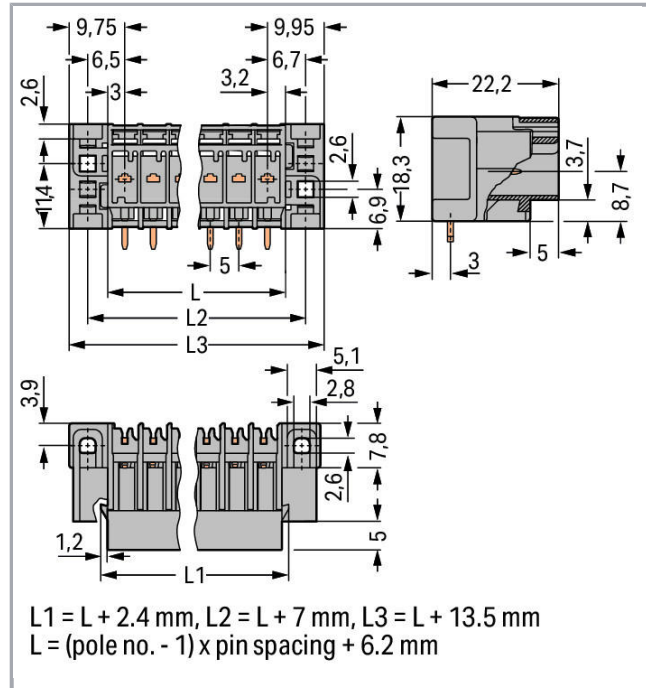

Data

Electrical data

Ratings per IEC/EN 60664-1

Rated voltage (III / 3)	250 V
Rated impulse voltage (III / 3)	4 kV
Rated voltage (III / 2)	500 V
Rated impulse voltage (III / 2)	4 kV
Rated current	32 A
Legend (ratings)	(III / 3) ≙ Overvoltage category III / Pollution degree 3

Subject to changes. Please also observe the further product documentation!

WAGO Kontakttechnik GmbH & Co. KG
Hansastr. 27
32423 Minden
Phone: +49571 887-0 | Fax: +49571 887-169
Email: info.de@wago.com | Web: www.wago.com

Do you have any questions about our products?
We are always happy to take your call at +49 (571) 887-44222.



Connection data

No. of poles	10
Total number of potentials	10
Number of levels	1

Geometrical Data

Pin spacing	5 mm / 0.197 inch
Width	64.7 mm / 2.547 inch
Height from the surface	18.3 mm / 0.72 inch
Depth	22.2 mm / 0.874 inch

Mechanical data

Mounting type	Mounting flange
---------------	-----------------

Plug connection

Contact type (pluggable connector)	Male connector/plug
Connector connection type	for PCBs
Mismating protection	No
Mating direction to the PCB	0°

PCB contact

PCB contact	THT
-------------	-----

Material Data

Color	gray
Insulating material	Polyamide 66 (PA 66)
Fire load	0.249 MJ
Weight	11.9 g

Commercial data

Product Group	18 (X-COM-System)
Packaging type	BOX
Country of origin	PL
GTIN	4044918397131

Subject to changes. Please also observe the further product documentation!

WAGO Kontakttechnik GmbH & Co. KG
 Hansastr. 27
 32423 Minden
 Phone: +49571 887-0 | Fax: +49571 887-169
 Email: info.de@wago.com | Web: www.wago.com





Do you have any questions about our products?
 We are always happy to take your call at +49 (571) 887-44222.

Customs Tariff No.

85366990990

Approvals / Certificates



Country specific Approvals

Logo	Approval	Additional Approval Text	Certificate name
	CCA DEKRA Certification B.V.	EN 60947	NTR NL-7626
	CCA DEKRA Certification B.V.	EN 61984	2190419.02
	CCA DEKRA Certification B.V.	IEC 61984	NL-47799 /A1
	CSA DEKRA Certification B.V.	C22.2 No. 158	1101144
	KEMA/KEUR DEKRA Certification B.V.	EN 60947	2190419.01

Ship Approvals

Logo	Approval	Additional Approval Text	Certificate name
	DNV GL Det Norske Veritas, Germanischer Lloyd	-	TAE00001V2

UL-Approvals

Logo	Approval	Additional Approval Text	Certificate name
	UR Underwriters Laboratories Inc.	UL 1977	20151210-E45171
	UR Underwriters Laboratories Inc.	UL 1059	20190731-E45172

Subject to changes. Please also observe the further product documentation!

Counterpart



Item no. 769-130

2-conductor female connector; 4 mm²; 10-pole; 4,00 mm²; gray

www.wago.com/769-130



Item no. 769-110

1-conductor female plug; 4 mm²; 10-pole; 4,00 mm²; gray

www.wago.com/769-110



Item no. 769-110/021-000

1-conductor female plug; Locking lever; 4 mm²; 10-pole; 4,00 mm²; gray

www.wago.com/769-110/021-000

Compatible products

Coding

Item no.: 769-435

Coding pin; for coding of female plugs; for carrier terminal blocks / male connectors; orange

www.wago.com/769-435

Marking accessories



Item no.: 210-831

Marking strips; on reel; 2.3 mm wide; plain; Self-adhesive; white

www.wago.com/210-831



Item no.: 210-832

Marking strips; on reel; 3 mm wide; plain; Self-adhesive; white

www.wago.com/210-832

Item no.: 210-833

Marking strips; on reel; 6 mm wide; plain; Self-adhesive; white

www.wago.com/210-833

Item no.: 210-834

Marking strips; on reel; 5 mm wide; plain; Self-adhesive; white

www.wago.com/210-834

Female plug

Subject to changes. Please also observe the further product documentation!

WAGO Kontakttechnik GmbH & Co. KG

Hansastr. 27















32423 Minden

Phone: +49571 887-0 | Fax: +49571 887-169















Email: info.de@wago.com | Web: www.wago.com

Do you have any questions about our products?

We are always happy to take your call at +49 (571) 887-44222.

	Item no.: 769-101 1-conductor female plug; 4 mm ² ; 1-pole; 4,00 mm ² ; gray	www.wago.com/769-101
	Item no.: 769-102 1-conductor female plug; 4 mm ² ; 2-pole; 4,00 mm ² ; gray	www.wago.com/769-102
	Item no.: 769-102/000-036 1-conductor female plug; 4 mm ² ; 2-pole; 4,00 mm ² ; gray, green-yellow	www.wago.com/769-102/000-036
	Item no.: 769-102/000-037 1-conductor female plug; 4 mm ² ; 2-pole; 4,00 mm ² ; green-yellow, gray	www.wago.com/769-102/000-037
	Item no.: 769-103 1-conductor female plug; 4 mm ² ; 3-pole; 4,00 mm ² ; gray	www.wago.com/769-103
	Item no.: 769-103/000-036 1-conductor female plug; 4 mm ² ; 3-pole; 4,00 mm ² ; gray, green-yellow	www.wago.com/769-103/000-036
	Item no.: 769-103/000-037 1-conductor female plug; 4 mm ² ; 3-pole; 4,00 mm ² ; green-yellow, gray	www.wago.com/769-103/000-037
	Item no.: 769-103/000-038 1-conductor female plug; 4 mm ² ; 3-pole; 4,00 mm ² ; gray, blue, green-yellow	www.wago.com/769-103/000-038
	Item no.: 769-103/000-039 1-conductor female plug; 4 mm ² ; 3-pole; 4,00 mm ² ; green-yellow, blue, gray	www.wago.com/769-103/000-039
	Item no.: 769-104 1-conductor female plug; 4 mm ² ; 4-pole; 4,00 mm ² ; gray	www.wago.com/769-104
	Item no.: 769-104/000-036 1-conductor female plug; 4 mm ² ; 4-pole; 4,00 mm ² ; gray, green-yellow	www.wago.com/769-104/000-036
	Item no.: 769-104/000-037 1-conductor female plug; 4 mm ² ; 4-pole; 4,00 mm ² ; green-yellow, gray	www.wago.com/769-104/000-037
	Item no.: 769-104/000-038 1-conductor female plug; 4 mm ² ; 4-pole; 4,00 mm ² ; gray, blue, green-yellow	www.wago.com/769-104/000-038
	Item no.: 769-104/000-039 1-conductor female plug; 4 mm ² ; 4-pole; 4,00 mm ² ; green-yellow, blue, gray	www.wago.com/769-104/000-039

Subject to changes. Please also observe the further product documentation!

	Item no.: 769-105 1-conductor female plug; 4 mm ² ; 5-pole; 4,00 mm ² ; gray	www.wago.com/769-105
	Item no.: 769-105/000-036 1-conductor female plug; 4 mm ² ; 5-pole; 4,00 mm ² ; gray, green-yellow	www.wago.com/769-105/000-036
	Item no.: 769-105/000-037 1-conductor female plug; 4 mm ² ; 5-pole; 4,00 mm ² ; green-yellow, gray	www.wago.com/769-105/000-037
	Item no.: 769-105/000-038 1-conductor female plug; 4 mm ² ; 5-pole; 4,00 mm ² ; gray, blue, green-yellow	www.wago.com/769-105/000-038
	Item no.: 769-105/000-039 1-conductor female plug; 4 mm ² ; 5-pole; 4,00 mm ² ; green-yellow, blue, gray	www.wago.com/769-105/000-039
	Item no.: 769-106 1-conductor female plug; 4 mm ² ; 6-pole; 4,00 mm ² ; gray	www.wago.com/769-106
	Item no.: 769-106/000-006 1-conductor female plug; 4 mm ² ; 6-pole; 4,00 mm ² ; blue	www.wago.com/769-106/000-006
	Item no.: 769-106/000-036 1-conductor female plug; 4 mm ² ; 6-pole; 4,00 mm ² ; gray, green-yellow	www.wago.com/769-106/000-036
	Item no.: 769-106/000-037 1-conductor female plug; 4 mm ² ; 6-pole; 4,00 mm ² ; green-yellow, gray	www.wago.com/769-106/000-037
	Item no.: 769-106/000-038 1-conductor female plug; 4 mm ² ; 6-pole; 4,00 mm ² ; gray, blue, green-yellow	www.wago.com/769-106/000-038
	Item no.: 769-106/000-039 1-conductor female plug; 4 mm ² ; 6-pole; 4,00 mm ² ; green-yellow, blue, gray	www.wago.com/769-106/000-039
	Item no.: 769-107 1-conductor female plug; 4 mm ² ; 7-pole; 4,00 mm ² ; gray	www.wago.com/769-107
	Item no.: 769-107/000-036 1-conductor female plug; 4 mm ² ; 7-pole; 4,00 mm ² ; gray, green-yellow	www.wago.com/769-107/000-036
	Item no.: 769-107/000-037 1-conductor female plug; 4 mm ² ; 7-pole; 4,00 mm ² ; green-yellow, gray	www.wago.com/769-107/000-037

Subject to changes. Please also observe the further product documentation!



Item no.: 769-107/000-038

1-conductor female plug; 4 mm²; 7-pole; 4,00 mm²; gray, blue, green-yellow

www.wago.com/769-107/000-038



Item no.: 769-107/000-039

1-conductor female plug; 4 mm²; 7-pole; 4,00 mm²; green-yellow, blue, gray

www.wago.com/769-107/000-039



Item no.: 769-108

1-conductor female plug; 4 mm²; 8-pole; 4,00 mm²; gray

www.wago.com/769-108



Item no.: 769-108/000-036

1-conductor female plug; 4 mm²; 8-pole; 4,00 mm²; gray, green-yellow

www.wago.com/769-108/000-036

Item no.: 769-108/000-037

1-conductor female plug; 4 mm²; 8-pole; 4,00 mm²; green-yellow, gray

www.wago.com/769-108/000-037



Item no.: 769-108/000-038

1-conductor female plug; 4 mm²; 8-pole; 4,00 mm²; gray, blue, green-yellow

www.wago.com/769-108/000-038



Item no.: 769-108/000-039

1-conductor female plug; 4 mm²; 8-pole; 4,00 mm²; green-yellow, blue, gray

www.wago.com/769-108/000-039



Item no.: 769-109

1-conductor female plug; 4 mm²; 9-pole; 4,00 mm²; gray

www.wago.com/769-109



Item no.: 769-109/000-036

1-conductor female plug; 4 mm²; 9-pole; 4,00 mm²; gray, green-yellow

www.wago.com/769-109/000-036



Item no.: 769-109/000-037

1-conductor female plug; 4 mm²; 9-pole; 4,00 mm²; green-yellow, gray

www.wago.com/769-109/000-037



Item no.: 769-109/000-038

1-conductor female plug; 4 mm²; 9-pole; 4,00 mm²; gray, blue, green-yellow

www.wago.com/769-109/000-038



Item no.: 769-109/000-039

1-conductor female plug; 4 mm²; 9-pole; 4,00 mm²; green-yellow, blue, gray

www.wago.com/769-109/000-039



Item no.: 769-110/000-036

1-conductor female plug; 4 mm²; 10-pole; 4,00 mm²; gray, green-yellow

www.wago.com/769-110/000-036



Item no.: 769-110/000-037

1-conductor female plug; 4 mm²; 10-pole; 4,00 mm²; green-yellow, gray

www.wago.com/769-110/000-037

Subject to changes. Please also observe the further product documentation!



Item no.: 769-110/000-038

1-conductor female plug; 4 mm²; 10-pole; 4,00 mm²; gray, blue, green-yellow

www.wago.com/769-110/000-038



Item no.: 769-110/000-039

1-conductor female plug; 4 mm²; 10-pole; 4,00 mm²; green-yellow, blue, gray

www.wago.com/769-110/000-039



Item no.: 769-111

1-conductor female plug; 4 mm²; 11-pole; 4,00 mm²; gray

www.wago.com/769-111



Item no.: 769-111/000-036

1-conductor female plug; 4 mm²; 11-pole; 4,00 mm²; gray, green-yellow

www.wago.com/769-111/000-036



Item no.: 769-111/000-037

1-conductor female plug; 4 mm²; 11-pole; 4,00 mm²; green-yellow, gray

www.wago.com/769-111/000-037



Item no.: 769-111/000-038

1-conductor female plug; 4 mm²; 11-pole; 4,00 mm²; gray, blue, green-yellow

www.wago.com/769-111/000-038



Item no.: 769-111/000-039

1-conductor female plug; 4 mm²; 11-pole; 4,00 mm²; green-yellow, blue, gray

www.wago.com/769-111/000-039



Item no.: 769-112

1-conductor female plug; 4 mm²; 12-pole; 4,00 mm²; gray

www.wago.com/769-112



Item no.: 769-112/000-036

1-conductor female plug; 4 mm²; 12-pole; 4,00 mm²; gray, green-yellow

www.wago.com/769-112/000-036



Item no.: 769-112/000-037

1-conductor female plug; 4 mm²; 12-pole; 4,00 mm²; green-yellow, gray

www.wago.com/769-112/000-037



Item no.: 769-112/000-038

1-conductor female plug; 4 mm²; 12-pole; 4,00 mm²; gray, blue, green-yellow

www.wago.com/769-112/000-038



Item no.: 769-112/000-039

1-conductor female plug; 4 mm²; 12-pole; 4,00 mm²; green-yellow, blue, gray

www.wago.com/769-112/000-039



Item no.: 769-113

1-conductor female plug; 4 mm²; 13-pole; 4,00 mm²; gray

www.wago.com/769-113



Item no.: 769-113/000-036

1-conductor female plug; 4 mm²; 13-pole; 4,00 mm²; gray, green-yellow

www.wago.com/769-113/000-036

Subject to changes. Please also observe the further product documentation!

WAGO Kontakttechnik GmbH & Co. KG

Hansastr. 27

32423 Minden

Phone: +49571 887-0 | Fax: +49571 887-169

Email: info.de@wago.com | Web: www.wago.com

Do you have any questions about our products?

We are always happy to take your call at +49 (571) 887-44222.



Item no.: 769-113/000-037

1-conductor female plug; 4 mm²; 13-pole; 4,00 mm²; green-yellow, gray

www.wago.com/769-113/000-037



Item no.: 769-113/000-038

1-conductor female plug; 4 mm²; 13-pole; 4,00 mm²; gray, blue, green-yellow

www.wago.com/769-113/000-038



Item no.: 769-113/000-039

1-conductor female plug; 4 mm²; 13-pole; 4,00 mm²; green-yellow, blue, gray

www.wago.com/769-113/000-039



Item no.: 769-114

1-conductor female plug; 4 mm²; 14-pole; 4,00 mm²; gray

www.wago.com/769-114



Item no.: 769-114/000-036

1-conductor female plug; 4 mm²; 14-pole; 4,00 mm²; gray, green-yellow

www.wago.com/769-114/000-036



Item no.: 769-114/000-037

1-conductor female plug; 4 mm²; 14-pole; 4,00 mm²; green-yellow, gray

www.wago.com/769-114/000-037



Item no.: 769-114/000-038

1-conductor female plug; 4 mm²; 14-pole; 4,00 mm²; gray, blue, green-yellow

www.wago.com/769-114/000-038



Item no.: 769-114/000-039

1-conductor female plug; 4 mm²; 14-pole; 4,00 mm²; green-yellow, blue, gray

www.wago.com/769-114/000-039



Item no.: 769-115

1-conductor female plug; 4 mm²; 15-pole; 4,00 mm²; gray

www.wago.com/769-115



Item no.: 769-115/000-036

1-conductor female plug; 4 mm²; 15-pole; 4,00 mm²; gray, green-yellow

www.wago.com/769-115/000-036



Item no.: 769-115/000-037

1-conductor female plug; 4 mm²; 15-pole; 4,00 mm²; green-yellow, gray

www.wago.com/769-115/000-037



Item no.: 769-115/000-038

1-conductor female plug; 4 mm²; 15-pole; 4,00 mm²; gray, blue, green-yellow

www.wago.com/769-115/000-038



Item no.: 769-115/000-039

1-conductor female plug; 4 mm²; 15-pole; 4,00 mm²; green-yellow, blue, gray

www.wago.com/769-115/000-039



Item no.: 769-121

2-conductor female connector; 4 mm²; 1-pole; 4,00 mm²; gray

www.wago.com/769-121

Subject to changes. Please also observe the further product documentation!

WAGO Kontakttechnik GmbH & Co. KG

Hansastr. 27















32423 Minden

Phone: +49571 887-0 | Fax: +49571 887-169

Email: info.de@wago.com | Web: www.wago.com

Do you have any questions about our products?

We are always happy to take your call at +49 (571) 887-44222.

	Item no.: 769-122 2-conductor female connector; 4 mm ² ; 2-pole; 4,00 mm ² ; gray	www.wago.com/769-122
	Item no.: 769-123 2-conductor female connector; 4 mm ² ; 3-pole; 4,00 mm ² ; gray	www.wago.com/769-123
	Item no.: 769-124 2-conductor female connector; 4 mm ² ; 4-pole; 4,00 mm ² ; gray	www.wago.com/769-124
	Item no.: 769-125 2-conductor female connector; 4 mm ² ; 5-pole; 4,00 mm ² ; gray	www.wago.com/769-125
	Item no.: 769-126 2-conductor female connector; 4 mm ² ; 6-pole; 4,00 mm ² ; gray	www.wago.com/769-126
	Item no.: 769-127 2-conductor female connector; 4 mm ² ; 7-pole; 4,00 mm ² ; gray	www.wago.com/769-127
	Item no.: 769-128 2-conductor female connector; 4 mm ² ; 8-pole; 4,00 mm ² ; gray	www.wago.com/769-128
	Item no.: 769-129 2-conductor female connector; 4 mm ² ; 9-pole; 4,00 mm ² ; gray	www.wago.com/769-129
	Item no.: 769-131 2-conductor female connector; 4 mm ² ; 11-pole; 4,00 mm ² ; gray	www.wago.com/769-131
	Item no.: 769-132 2-conductor female connector; 4 mm ² ; 12-pole; 4,00 mm ² ; gray	www.wago.com/769-132
	Item no.: 769-133 2-conductor female connector; 4 mm ² ; 13-pole; 4,00 mm ² ; gray	www.wago.com/769-133
	Item no.: 769-134 2-conductor female connector; 4 mm ² ; 14-pole; 4,00 mm ² ; gray	www.wago.com/769-134
	Item no.: 769-135 2-conductor female connector; 4 mm ² ; 15-pole; 4,00 mm ² ; gray	www.wago.com/769-135
ferrule		
	Item no.: 216-101 Ferrule; Sleeve for 0.5 mm ² / AWG 22; uninsulated; electro-tin plated	www.wago.com/216-101
	Item no.: 216-102 Ferrule; Sleeve for 0.75 mm ² / AWG 20; uninsulated; electro-tin plated	www.wago.com/216-102
	Item no.: 216-103 Ferrule; Sleeve for 1 mm ² / AWG 18; uninsulated; electro-tin plated	www.wago.com/216-103
	Item no.: 216-104 Ferrule; Sleeve for 1.5 mm ² / AWG 16; uninsulated; electro-tin plated	www.wago.com/216-104
	Item no.: 216-201 Ferrule; Sleeve for 0.5 mm ² / 20 AWG; insulated; electro-tin plated; white	www.wago.com/216-201

Subject to changes. Please also observe the further product documentation!



	Item no.: 216-202 Ferrule; Sleeve for 0.75 mm ² / 18 AWG; insulated; electro-tin plated; gray	www.wago.com/216-202
	Item no.: 216-203 Ferrule; Sleeve for 1 mm ² / AWG 18; insulated; electro-tin plated; red	www.wago.com/216-203
	Item no.: 216-204 Ferrule; Sleeve for 1.5 mm ² / AWG 16; insulated; electro-tin plated; black	www.wago.com/216-204
	Item no.: 216-206 Ferrule; Sleeve for 2.5 mm ² / AWG 14; insulated; electro-tin plated; blue	www.wago.com/216-206
	Item no.: 216-301 Ferrule; Sleeve for 0.25 mm ² / AWG 24; insulated; electro-tin plated; yellow	www.wago.com/216-301
	Item no.: 216-302 Ferrule; Sleeve for 0.34 mm ² / 22 AWG; insulated; electro-tin plated; green	www.wago.com/216-302

Downloads

Documentation

Additional Information

Technical explanations	Apr 3, 2019	pdf 2.1 MB	Download
------------------------	-------------	---------------	----------

CAD/CAE-Data

CAD data

2D/3D Models 769-670/004-000	URL	Download
------------------------------	-----	----------

PCB Design

Symbol and Footprint 769-670/004-000	URL	Download
--------------------------------------	-----	----------

CAX data for your PCB design, consisting of "schematic symbols and PCB footprints", allow easy integration of the WAGO component into your development environment.

Supported formats:

- Accel EDA 14 & 15
- Altium 6 to current version
- Cadence Allegro
- DesignSpark
- Eagle Libraries
- KiCad
- Mentor Graphics BoardStation

Subject to changes. Please also observe the further product documentation!

- Mentor Graphics Design Architect
- Mentor Graphics Design Expedition 99 and 2000
- OrCAD 9.X PCB and Capture
- PADS PowerPCB 3, 3.5, 4.X, and 5.X
- PADS PowerPCB and PowerLogic 3.0
- PCAD 2000, 2001, 2002, 2004, and 2006
- Pulsonix 8.5 or newer
- STL
- 3D STEP
- TARGET 3001!
- View Logic ViewDraw
- Quadcept
- Zuken CadStar 3 and 4
- Zuken CR-5000 and CR-8000

PCB Component Libraries (EDA), PCB CAD Library Ultra Librarian

Installation Notes

Assembly

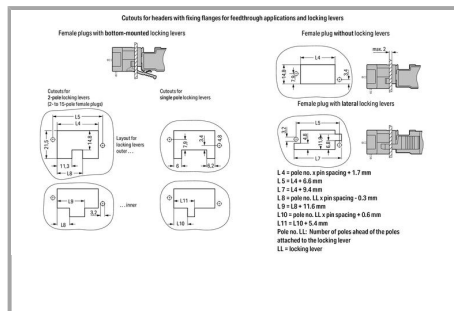

Cutouts for headers with fixing flanges for feedthrough applications and locking levers

Application

Subject to changes. Please also observe the further product documentation!

WAGO Kontakttechnik GmbH & Co. KG
Hansastr. 27
32423 Minden
Phone: +49571 887-0 | Fax: +49571 887-169
Email: info.de@wago.com | Web: www.wago.com

Do you have any questions about our products?
We are always happy to take your call at +49 (571) 887-44222.

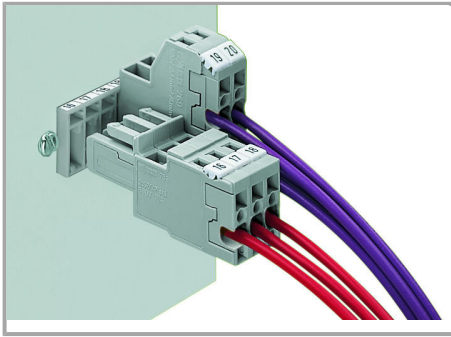

Male header with straight or angled solder pins and feedthrough flanges

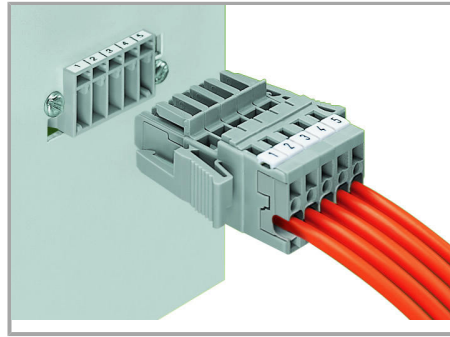

Male header and 1-conductor female plug with lateral locking levers

1-conductor female plug

2-conductor female plug

Product family

X-COM

[Learn more about the product family.](#)

[Show all products from the family](#)

Subject to changes. Please also observe the further product documentation!