

Data sheet | Item number: 769-664/004-000

THT male header; 1.0 x 1.0 mm solder pin; angled; Pin spacing 5 mm; 4-pole; gray

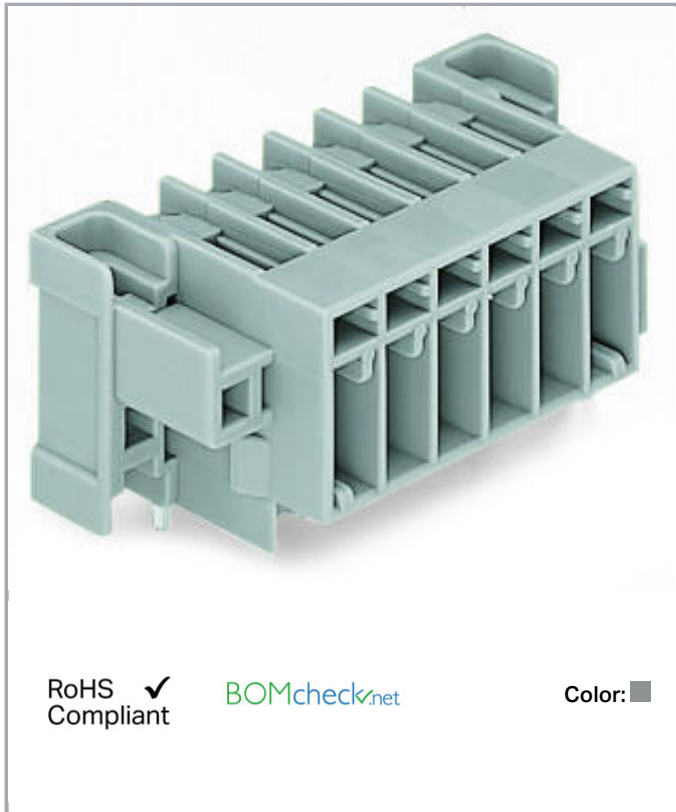

www.wago.com/769-664/004-000



RoHS Compliant

BOMcheck.net

Color: ■

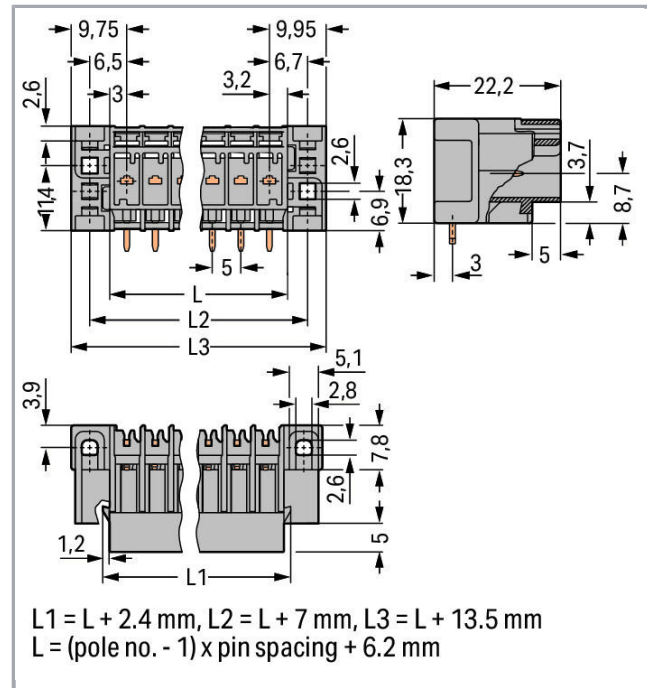

Data

Electrical data

Ratings per IEC/EN 60664-1

Rated voltage (III / 3)	250 V
Rated impulse voltage (III / 3)	4 kV
Rated voltage (III / 2)	500 V
Rated impulse voltage (III / 2)	4 kV
Rated current	32 A
Legend (ratings)	(III / 3) ≙ Overvoltage category III / Pollution degree 3

Subject to changes. Please also observe the further product documentation!

WAGO Kontakttechnik GmbH & Co. KG
Hansastr. 27
32423 Minden
Phone: +49571 887-0 | Fax: +49571 887-169
Email: info.de@wago.com | Web: www.wago.com

Do you have any questions about our products?
We are always happy to take your call at +49 (571) 887-44222.



Connection data

No. of poles	4
Total number of potentials	4
Number of levels	1

Geometrical Data

Pin spacing	5 mm / 0.197 inch
Width	34,7 mm / 1.366 inch
Height from the surface	18,3 mm / 0.72 inch
Depth	22,2 mm / 0.874 inch

Mechanical data

Mounting type	Mounting flange
---------------	-----------------

Plug connection

Contact type (pluggable connector)	Male connector/plug
Connector connection type	for PCB
Mismating protection	No
Mating direction to the PCB	0°

PCB contact

PCB contact	THT
-------------	-----

Material Data

Color	gray
Insulating material	Polyamide 66 (PA 66)
Fire load	0.135 MJ
Weight	6 g

Commercial data

Product Group	18 (X-COM-System)
Packaging type	BOX
Country of origin	PL
GTIN	4044918396677

Subject to changes. Please also observe the further product documentation!

WAGO Kontakttechnik GmbH & Co. KG
Hansastr. 27
32423 Minden
Phone: +49571 887-0 | Fax: +49571 887-169
Email: info.de@wago.com | Web: www.wago.com





Do you have any questions about our products?
We are always happy to take your call at +49 (571) 887-44222.

Customs Tariff No.

85366990990

Approvals / Certificates



Country specific Approvals

Logo	Approval	Additional Approval Text	Certificate name
	CCA DEKRA Certification B.V.	EN 60947	NTR NL-7626
	CCA DEKRA Certification B.V.	EN 61984	2190419.02
	CCA DEKRA Certification B.V.	IEC 61984	NL-47799 /A1
	CSA DEKRA Certification B.V.	C22.2 No. 158	1101144
	KEMA/KEUR DEKRA Certification B.V.	EN 60947	2190419.01

Ship Approvals

Logo	Approval	Additional Approval Text	Certificate name
	DNV GL Det Norske Veritas, Germanischer Lloyd	-	TAE00001V2

UL-Approvals

Logo	Approval	Additional Approval Text	Certificate name
	UR Underwriters Laboratories Inc.	UL 1977	20151210-E45171
	UR Underwriters Laboratories Inc.	UL 1059	20190731-E45172

Subject to changes. Please also observe the further product documentation!

Counterpart



Item no. 769-104

1-conductor female plug; 4 mm²; 4-pole; 4,00 mm²; gray

www.wago.com/769-104



Item no. 769-104/021-000

1-conductor female plug; Locking lever; 4 mm²; 4-pole; 4,00 mm²; gray

www.wago.com/769-104/021-000



Item no. 769-124

2-conductor female connector; 4 mm²; 4-pole; 4,00 mm²; gray

www.wago.com/769-124

Compatible products

ferrule



Item no.: 216-101

Ferrule; Sleeve for 0.5 mm² / AWG 22; uninsulated; electro-tin plated

www.wago.com/216-101



Item no.: 216-102

Ferrule; Sleeve for 0.75 mm² / AWG 20; uninsulated; electro-tin plated

www.wago.com/216-102



Item no.: 216-103

Ferrule; Sleeve for 1 mm² / AWG 18; uninsulated; electro-tin plated

www.wago.com/216-103

Item no.: 216-104

Ferrule; Sleeve for 1.5 mm² / AWG 16; uninsulated; electro-tin plated

www.wago.com/216-104

Item no.: 216-201

Ferrule; Sleeve for 0.5 mm² / 20 AWG; insulated; electro-tin plated; white

www.wago.com/216-201

Subject to changes. Please also observe the further product documentation!

WAGO Kontakttechnik GmbH & Co. KG

Hansastr. 27



32423 Minden

Phone: +49571 887-0 | Fax: +49571 887-169

Email: info.de@wago.com | Web: www.wago.com

Do you have any questions about our products?

We are always happy to take your call at +49 (571) 887-44222.

	Item no.: 216-202 Ferrule; Sleeve for 0.75 mm ² / 18 AWG; insulated; electro-tin plated; gray	www.wago.com/216-202
	Item no.: 216-203 Ferrule; Sleeve for 1 mm ² / AWG 18; insulated; electro-tin plated; red	www.wago.com/216-203
	Item no.: 216-204 Ferrule; Sleeve for 1.5 mm ² / AWG 16; insulated; electro-tin plated; black	www.wago.com/216-204
	Item no.: 216-206 Ferrule; Sleeve for 2.5 mm ² / AWG 14; insulated; electro-tin plated; blue	www.wago.com/216-206
	Item no.: 216-301 Ferrule; Sleeve for 0.25 mm ² / AWG 24; insulated; electro-tin plated; yellow	www.wago.com/216-301
	Item no.: 216-302 Ferrule; Sleeve for 0.34 mm ² / 22 AWG; insulated; electro-tin plated; green	www.wago.com/216-302
Female plug		
	Item no.: 769-101 1-conductor female plug; 4 mm ² ; 1-pole; 4,00 mm ² ; gray	www.wago.com/769-101
	Item no.: 769-102 1-conductor female plug; 4 mm ² ; 2-pole; 4,00 mm ² ; gray	www.wago.com/769-102
	Item no.: 769-102/000-036 1-conductor female plug; 4 mm ² ; 2-pole; 4,00 mm ² ; gray, green-yellow	www.wago.com/769-102/000-036
	Item no.: 769-102/000-037 1-conductor female plug; 4 mm ² ; 2-pole; 4,00 mm ² ; green-yellow, gray	www.wago.com/769-102/000-037
	Item no.: 769-103 1-conductor female plug; 4 mm ² ; 3-pole; 4,00 mm ² ; gray	www.wago.com/769-103
	Item no.: 769-103/000-036 1-conductor female plug; 4 mm ² ; 3-pole; 4,00 mm ² ; gray, green-yellow	www.wago.com/769-103/000-036
	Item no.: 769-103/000-037 1-conductor female plug; 4 mm ² ; 3-pole; 4,00 mm ² ; green-yellow, gray	www.wago.com/769-103/000-037
	Item no.: 769-103/000-038 1-conductor female plug; 4 mm ² ; 3-pole; 4,00 mm ² ; gray, blue, green-yellow	www.wago.com/769-103/000-038
	Item no.: 769-103/000-039 1-conductor female plug; 4 mm ² ; 3-pole; 4,00 mm ² ; green-yellow, blue, gray	www.wago.com/769-103/000-039

Subject to changes. Please also observe the further product documentation!

Item no.: 769-104/000-036

1-conductor female plug; 4 mm²; 4-pole; 4,00 mm²; gray, green-yellow

www.wago.com/769-104/000-036

Item no.: 769-104/000-037

1-conductor female plug; 4 mm²; 4-pole; 4,00 mm²; green-yellow, gray

www.wago.com/769-104/000-037

Item no.: 769-104/000-038

1-conductor female plug; 4 mm²; 4-pole; 4,00 mm²; gray, blue, green-yellow

www.wago.com/769-104/000-038

Item no.: 769-104/000-039

1-conductor female plug; 4 mm²; 4-pole; 4,00 mm²; green-yellow, blue, gray

www.wago.com/769-104/000-039

Item no.: 769-105

1-conductor female plug; 4 mm²; 5-pole; 4,00 mm²; gray

www.wago.com/769-105

Item no.: 769-105/000-036

1-conductor female plug; 4 mm²; 5-pole; 4,00 mm²; gray, green-yellow

www.wago.com/769-105/000-036

Item no.: 769-105/000-037

1-conductor female plug; 4 mm²; 5-pole; 4,00 mm²; green-yellow, gray

www.wago.com/769-105/000-037

Item no.: 769-105/000-038

1-conductor female plug; 4 mm²; 5-pole; 4,00 mm²; gray, blue, green-yellow

www.wago.com/769-105/000-038



Item no.: 769-105/000-039

1-conductor female plug; 4 mm²; 5-pole; 4,00 mm²; green-yellow, blue, gray

www.wago.com/769-105/000-039



Item no.: 769-106

1-conductor female plug; 4 mm²; 6-pole; 4,00 mm²; gray

www.wago.com/769-106



Item no.: 769-106/000-006

1-conductor female plug; 4 mm²; 6-pole; 4,00 mm²; blue

www.wago.com/769-106/000-006



Item no.: 769-106/000-036

1-conductor female plug; 4 mm²; 6-pole; 4,00 mm²; gray, green-yellow

www.wago.com/769-106/000-036



Item no.: 769-106/000-037

1-conductor female plug; 4 mm²; 6-pole; 4,00 mm²; green-yellow, gray

www.wago.com/769-106/000-037



Item no.: 769-106/000-038

1-conductor female plug; 4 mm²; 6-pole; 4,00 mm²; gray, blue, green-yellow

www.wago.com/769-106/000-038

Subject to changes. Please also observe the further product documentation!

WAGO Kontakttechnik GmbH & Co. KG

Hansastr. 27







32423 Minden

Phone: +49571 887-0 | Fax: +49571 887-169













Email: info.de@wago.com | Web: www.wago.com

Do you have any questions about our products?

We are always happy to take your call at +49 (571) 887-44222.

	Item no.: 769-106/000-039 1-conductor female plug; 4 mm ² ; 6-pole; 4,00 mm ² ; green-yellow, blue, gray	www.wago.com/769-106/000-039
	Item no.: 769-107 1-conductor female plug; 4 mm ² ; 7-pole; 4,00 mm ² ; gray	www.wago.com/769-107
	Item no.: 769-107/000-036 1-conductor female plug; 4 mm ² ; 7-pole; 4,00 mm ² ; gray, green-yellow	www.wago.com/769-107/000-036
	Item no.: 769-107/000-037 1-conductor female plug; 4 mm ² ; 7-pole; 4,00 mm ² ; green-yellow, gray	www.wago.com/769-107/000-037
	Item no.: 769-107/000-038 1-conductor female plug; 4 mm ² ; 7-pole; 4,00 mm ² ; gray, blue, green-yellow	www.wago.com/769-107/000-038
	Item no.: 769-107/000-039 1-conductor female plug; 4 mm ² ; 7-pole; 4,00 mm ² ; green-yellow, blue, gray	www.wago.com/769-107/000-039
	Item no.: 769-108 1-conductor female plug; 4 mm ² ; 8-pole; 4,00 mm ² ; gray	www.wago.com/769-108
	Item no.: 769-108/000-036 1-conductor female plug; 4 mm ² ; 8-pole; 4,00 mm ² ; gray, green-yellow	www.wago.com/769-108/000-036
	Item no.: 769-108/000-037 1-conductor female plug; 4 mm ² ; 8-pole; 4,00 mm ² ; green-yellow, gray	www.wago.com/769-108/000-037
	Item no.: 769-108/000-038 1-conductor female plug; 4 mm ² ; 8-pole; 4,00 mm ² ; gray, blue, green-yellow	www.wago.com/769-108/000-038
	Item no.: 769-108/000-039 1-conductor female plug; 4 mm ² ; 8-pole; 4,00 mm ² ; green-yellow, blue, gray	www.wago.com/769-108/000-039
	Item no.: 769-109 1-conductor female plug; 4 mm ² ; 9-pole; 4,00 mm ² ; gray	www.wago.com/769-109
	Item no.: 769-109/000-036 1-conductor female plug; 4 mm ² ; 9-pole; 4,00 mm ² ; gray, green-yellow	www.wago.com/769-109/000-036
	Item no.: 769-109/000-037 1-conductor female plug; 4 mm ² ; 9-pole; 4,00 mm ² ; green-yellow, gray	www.wago.com/769-109/000-037

Subject to changes. Please also observe the further product documentation!

	Item no.: 769-109/000-038 1-conductor female plug; 4 mm ² ; 9-pole; 4,00 mm ² ; gray, blue, green-yellow	www.wago.com/769-109/000-038
	Item no.: 769-109/000-039 1-conductor female plug; 4 mm ² ; 9-pole; 4,00 mm ² ; green-yellow, blue, gray	www.wago.com/769-109/000-039
	Item no.: 769-110 1-conductor female plug; 4 mm ² ; 10-pole; 4,00 mm ² ; gray	www.wago.com/769-110
	Item no.: 769-110/000-036 1-conductor female plug; 4 mm ² ; 10-pole; 4,00 mm ² ; gray, green-yellow	www.wago.com/769-110/000-036
	Item no.: 769-110/000-037 1-conductor female plug; 4 mm ² ; 10-pole; 4,00 mm ² ; green-yellow, gray	www.wago.com/769-110/000-037
	Item no.: 769-110/000-038 1-conductor female plug; 4 mm ² ; 10-pole; 4,00 mm ² ; gray, blue, green-yellow	www.wago.com/769-110/000-038
	Item no.: 769-110/000-039 1-conductor female plug; 4 mm ² ; 10-pole; 4,00 mm ² ; green-yellow, blue, gray	www.wago.com/769-110/000-039
	Item no.: 769-111 1-conductor female plug; 4 mm ² ; 11-pole; 4,00 mm ² ; gray	www.wago.com/769-111
	Item no.: 769-111/000-036 1-conductor female plug; 4 mm ² ; 11-pole; 4,00 mm ² ; gray, green-yellow	www.wago.com/769-111/000-036
	Item no.: 769-111/000-037 1-conductor female plug; 4 mm ² ; 11-pole; 4,00 mm ² ; green-yellow, gray	www.wago.com/769-111/000-037
	Item no.: 769-111/000-038 1-conductor female plug; 4 mm ² ; 11-pole; 4,00 mm ² ; gray, blue, green-yellow	www.wago.com/769-111/000-038
	Item no.: 769-111/000-039 1-conductor female plug; 4 mm ² ; 11-pole; 4,00 mm ² ; green-yellow, blue, gray	www.wago.com/769-111/000-039
	Item no.: 769-112 1-conductor female plug; 4 mm ² ; 12-pole; 4,00 mm ² ; gray	www.wago.com/769-112
	Item no.: 769-112/000-036 1-conductor female plug; 4 mm ² ; 12-pole; 4,00 mm ² ; gray, green-yellow	www.wago.com/769-112/000-036

Subject to changes. Please also observe the further product documentation!



Item no.: 769-112/000-037

1-conductor female plug; 4 mm²; 12-pole; 4,00 mm²; green-yellow, gray

www.wago.com/769-112/000-037



Item no.: 769-112/000-038

1-conductor female plug; 4 mm²; 12-pole; 4,00 mm²; gray, blue, green-yellow

www.wago.com/769-112/000-038



Item no.: 769-112/000-039

1-conductor female plug; 4 mm²; 12-pole; 4,00 mm²; green-yellow, blue, gray

www.wago.com/769-112/000-039



Item no.: 769-113

1-conductor female plug; 4 mm²; 13-pole; 4,00 mm²; gray

www.wago.com/769-113



Item no.: 769-113/000-036

1-conductor female plug; 4 mm²; 13-pole; 4,00 mm²; gray, green-yellow

www.wago.com/769-113/000-036



Item no.: 769-113/000-037

1-conductor female plug; 4 mm²; 13-pole; 4,00 mm²; green-yellow, gray

www.wago.com/769-113/000-037



Item no.: 769-113/000-038

1-conductor female plug; 4 mm²; 13-pole; 4,00 mm²; gray, blue, green-yellow

www.wago.com/769-113/000-038



Item no.: 769-113/000-039

1-conductor female plug; 4 mm²; 13-pole; 4,00 mm²; green-yellow, blue, gray

www.wago.com/769-113/000-039



Item no.: 769-114

1-conductor female plug; 4 mm²; 14-pole; 4,00 mm²; gray

www.wago.com/769-114



Item no.: 769-114/000-036

1-conductor female plug; 4 mm²; 14-pole; 4,00 mm²; gray, green-yellow

www.wago.com/769-114/000-036



Item no.: 769-114/000-037

1-conductor female plug; 4 mm²; 14-pole; 4,00 mm²; green-yellow, gray

www.wago.com/769-114/000-037



Item no.: 769-114/000-038

1-conductor female plug; 4 mm²; 14-pole; 4,00 mm²; gray, blue, green-yellow

www.wago.com/769-114/000-038



Item no.: 769-114/000-039

1-conductor female plug; 4 mm²; 14-pole; 4,00 mm²; green-yellow, blue, gray

www.wago.com/769-114/000-039



Item no.: 769-115

1-conductor female plug; 4 mm²; 15-pole; 4,00 mm²; gray

www.wago.com/769-115

Subject to changes. Please also observe the further product documentation!

WAGO Kontakttechnik GmbH & Co. KG

Hansastr. 27

















32423 Minden

Phone: +49571 887-0 | Fax: +49571 887-169

Email: info.de@wago.com | Web: www.wago.com

Do you have any questions about our products?

We are always happy to take your call at +49 (571) 887-44222.

	<p>Item no.: 769-115/000-036 1-conductor female plug; 4 mm²; 15-pole; 4,00 mm²; gray, green-yellow</p>	www.wago.com/769-115/000-036
	<p>Item no.: 769-115/000-037 1-conductor female plug; 4 mm²; 15-pole; 4,00 mm²; green-yellow, gray</p>	www.wago.com/769-115/000-037
	<p>Item no.: 769-115/000-038 1-conductor female plug; 4 mm²; 15-pole; 4,00 mm²; gray, blue, green-yellow</p>	www.wago.com/769-115/000-038
	<p>Item no.: 769-115/000-039 1-conductor female plug; 4 mm²; 15-pole; 4,00 mm²; green-yellow, blue, gray</p>	www.wago.com/769-115/000-039
	<p>Item no.: 769-121 2-conductor female connector; 4 mm²; 1-pole; 4,00 mm²; gray</p>	www.wago.com/769-121
	<p>Item no.: 769-122 2-conductor female connector; 4 mm²; 2-pole; 4,00 mm²; gray</p>	www.wago.com/769-122
	<p>Item no.: 769-123 2-conductor female connector; 4 mm²; 3-pole; 4,00 mm²; gray</p>	www.wago.com/769-123
	<p>Item no.: 769-125 2-conductor female connector; 4 mm²; 5-pole; 4,00 mm²; gray</p>	www.wago.com/769-125
	<p>Item no.: 769-126 2-conductor female connector; 4 mm²; 6-pole; 4,00 mm²; gray</p>	www.wago.com/769-126
	<p>Item no.: 769-127 2-conductor female connector; 4 mm²; 7-pole; 4,00 mm²; gray</p>	www.wago.com/769-127
	<p>Item no.: 769-128 2-conductor female connector; 4 mm²; 8-pole; 4,00 mm²; gray</p>	www.wago.com/769-128
	<p>Item no.: 769-129 2-conductor female connector; 4 mm²; 9-pole; 4,00 mm²; gray</p>	www.wago.com/769-129
	<p>Item no.: 769-130 2-conductor female connector; 4 mm²; 10-pole; 4,00 mm²; gray</p>	www.wago.com/769-130
	<p>Item no.: 769-131 2-conductor female connector; 4 mm²; 11-pole; 4,00 mm²; gray</p>	www.wago.com/769-131
	<p>Item no.: 769-132 2-conductor female connector; 4 mm²; 12-pole; 4,00 mm²; gray</p>	www.wago.com/769-132
	<p>Item no.: 769-133 2-conductor female connector; 4 mm²; 13-pole; 4,00 mm²; gray</p>	www.wago.com/769-133
	<p>Item no.: 769-134 2-conductor female connector; 4 mm²; 14-pole; 4,00 mm²; gray</p>	www.wago.com/769-134

Subject to changes. Please also observe the further product documentation!



Item no.: 769-135
2-conductor female connector; 4 mm²; 15-pole; 4,00 mm²; gray

www.wago.com/769-135

Marking accessories

Item no.: 210-831 Marking strips; on reel; 2.3 mm wide; plain; Self-adhesive; white	www.wago.com/210-831
Item no.: 210-832 Marking strips; on reel; 3 mm wide; plain; Self-adhesive; white	www.wago.com/210-832
Item no.: 210-833 Marking strips; on reel; 6 mm wide; plain; Self-adhesive; white	www.wago.com/210-833
Item no.: 210-834 Marking strips; on reel; 5 mm wide; plain; Self-adhesive; white	www.wago.com/210-834

Coding

Item no.: 769-435 Coding pin; for coding of female plugs; for carrier terminal blocks / male connectors; orange	www.wago.com/769-435
---------------------------------------------------------------------------------------------------------------------------	----------------------------------------------------------------

Downloads

Documentation

Additional Information

Technical explanations	Apr 3, 2019	pdf 2.1 MB	Download
------------------------	-------------	---------------	----------

CAD/CAE-Data

CAD data

2D/3D Models 769-664/004-000	URL	Download
------------------------------	-----	----------

PCB Design

Symbol and Footprint 769-664/004-000	URL	Download
--------------------------------------	-----	----------

CAX data for your PCB design, consisting of "schematic symbols and PCB footprints", allow easy integration of the WAGO component into your development environment.

Supported formats:

- Accel EDA 14 & 15
- Altium 6 to current version
- Cadence Allegro
- DesignSpark
- Eagle Libraries

—
Subject to changes. Please also observe the further product documentation!

WAGO Kontakttechnik GmbH & Co. KG
Hansastr. 27
32423 Minden
Phone: +49571 887-0 | Fax: +49571 887-169
Email: info.de@wago.com | Web: www.wago.com

Do you have any questions about our products?
We are always happy to take your call at +49 (571) 887-44222.

- KiCad
- Mentor Graphics BoardStation
- Mentor Graphics Design Architect
- Mentor Graphics Design Expedition 99 and 2000
- OrCAD 9.X PCB and Capture
- PADS PowerPCB 3, 3.5, 4.X, and 5.X
- PADS PowerPCB and PowerLogic 3.0
- PCAD 2000, 2001, 2002, 2004, and 2006
- Pulsonix 8.5 or newer
- STL
- 3D STEP
- TARGET 3001!
- View Logic ViewDraw
- Quadcept
- Zuken CadStar 3 and 4
- Zuken CR-5000 and CR-8000

PCB Component Libraries (EDA), PCB CAD Library Ultra Librarian

Installation Notes

Assembly

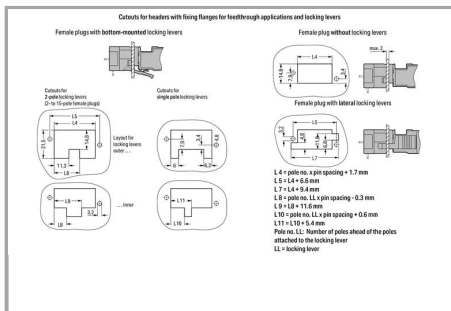

Cutouts for headers with fixing flanges for feedthrough applications and locking levers

Application

Subject to changes. Please also observe the further product documentation!

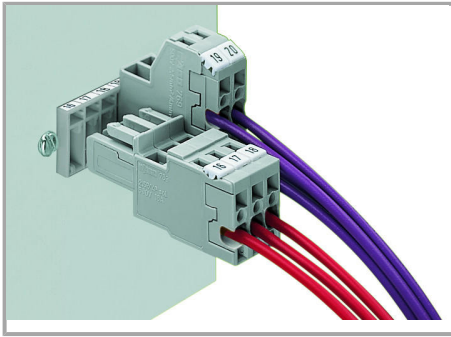

Male header with straight or angled solder pins and feedthrough flanges

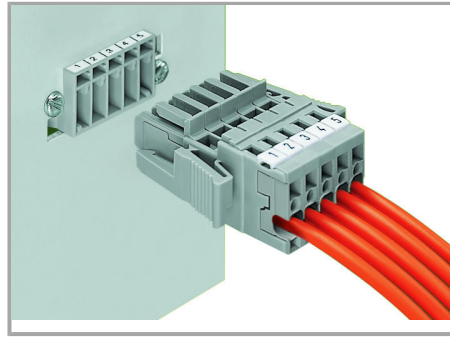

Male header and 1-conductor female plug with lateral locking levers

1-conductor female plug

2-conductor female plug

Product family

X-COM

[Learn more about the product family.](#)

[Show all products from the family](#)

Subject to changes. Please also observe the further product documentation!