

## Data sheet | Item number: 769-642

THT male header; 1.0 x 1.0 mm solder pin; straight; Pin spacing 5 mm; 12-pole; gray

[www.wago.com/769-642](http://www.wago.com/769-642)

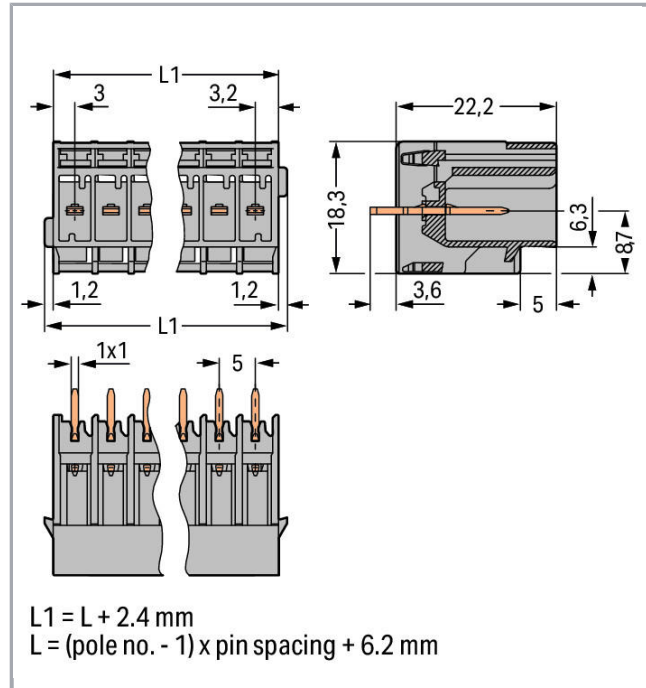
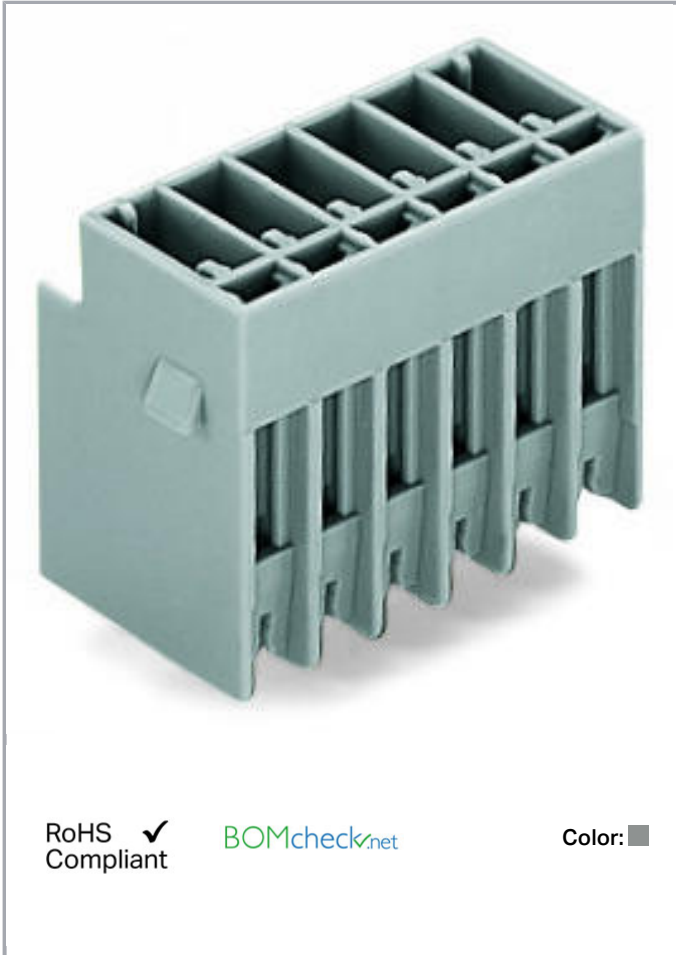

### Data

#### Electrical data

#### Ratings per IEC/EN 60664-1

Rated voltage (III / 3)	250 V
Rated impulse voltage (III / 3)	4 kV
Rated voltage (III / 2)	500 V
Rated impulse voltage (III / 2)	4 kV
Rated current	32 A

Subject to changes. Please also observe the further product documentation!

WAGO Kontakttechnik GmbH & Co. KG  
Hansastr. 27  
32423 Minden  
Phone: +49571 887-0 | Fax: +49571 887-169  
Email: [info.de@wago.com](mailto:info.de@wago.com) | Web: [www.wago.com](http://www.wago.com)

Do you have any questions about our products?  
We are always happy to take your call at +49 (571) 887-44222.



Legend (ratings)

(III / 3) ≙ Overvoltage category III / Pollution degree 3

**Connection data**

No. of poles	12
Total number of potentials	12
Number of levels	1

**Geometrical Data**

Pin spacing	5 mm / 0.197 inch
Width	63,6 mm / 2.504 inch
Height from the surface	22,2 mm / 0.874 inch
Depth	18,3 mm / 0.72 inch

**Plug connection**

Contact type (pluggable connector)	Male connector/plug
Connector connection type	for PCBs
Mismating protection	No
Mating direction to the PCB	90°

**PCB contact**

PCB contact	THT
-------------	-----

**Material Data**

Color	gray
Insulating material	Polyamide 66 (PA 66)
Fire load	0.261 MJ
Weight	12.3 g

**Commercial data**

Product Group	18 (X-COM-System)
Packaging type	BOX
Country of origin	PL
GTIN	4044918270779
Customs Tariff No.	85366990990





**Approvals / Certificates**

Subject to changes. Please also observe the further product documentation!

WAGO Kontakttechnik GmbH & Co. KG  
Hansastr. 27  
32423 Minden  
Phone: +49571 887-0 | Fax: +49571 887-169  
Email: [info.de@wago.com](mailto:info.de@wago.com) | Web: [www.wago.com](http://www.wago.com)

Do you have any questions about our products?  
We are always happy to take your call at +49 (571) 887-44222.



## Country specific Approvals

Logo	Approval	Additional Approval Text	Certificate name
	<b>CCA</b> DEKRA Certification B.V.	EN 61984	2190419.02
	<b>CCA</b> DEKRA Certification B.V.	EN 60947	NTR NL-7626
	<b>CCA</b> DEKRA Certification B.V.	IEC 61984	NL-47799 /A1
	<b>CSA</b> DEKRA Certification B.V.	C22.2 No. 158	1101144
	<b>KEMA/KEUR</b> DEKRA Certification B.V.	EN 60947	2190419.01

## Ship Approvals

Logo	Approval	Additional Approval Text	Certificate name
	<b>DNV GL</b> Det Norske Veritas, Germanischer Lloyd	-	TAE00001V2

## UL-Approvals

Logo	Approval	Additional Approval Text	Certificate name
	<b>UR</b> Underwriters Laboratories Inc.	UL 1059	20190731-E45172
	<b>UR</b> Underwriters Laboratories Inc.	UL 1977	20151210-E45171

Subject to changes. Please also observe the further product documentation!

## Counterpart



**Item no.769-112**

1-conductor female plug; 4 mm<sup>2</sup>; 12-pole; 4,00 mm<sup>2</sup>; gray

[www.wago.com/769-112](http://www.wago.com/769-112)



**Item no.769-112/021-000**

1-conductor female plug; Locking lever; 4 mm<sup>2</sup>; 12-pole; 4,00 mm<sup>2</sup>; gray

[www.wago.com/769-112/021-000](http://www.wago.com/769-112/021-000)



**Item no.769-132**

2-conductor female connector; 4 mm<sup>2</sup>; 12-pole; 4,00 mm<sup>2</sup>; gray

[www.wago.com/769-132](http://www.wago.com/769-132)

## Compatible products

### Coding

**Item no.: 769-435**

Coding pin; for coding of female plugs; for carrier terminal blocks / male connectors; orange

[www.wago.com/769-435](http://www.wago.com/769-435)

### Female plug

**Item no.: 769-101**

1-conductor female plug; 4 mm<sup>2</sup>; 1-pole; 4,00 mm<sup>2</sup>; gray

[www.wago.com/769-101](http://www.wago.com/769-101)



**Item no.: 769-102**

1-conductor female plug; 4 mm<sup>2</sup>; 2-pole; 4,00 mm<sup>2</sup>; gray

[www.wago.com/769-102](http://www.wago.com/769-102)



**Item no.: 769-102/000-036**

1-conductor female plug; 4 mm<sup>2</sup>; 2-pole; 4,00 mm<sup>2</sup>; gray, green-yellow

[www.wago.com/769-102/000-036](http://www.wago.com/769-102/000-036)



**Item no.: 769-102/000-037**

1-conductor female plug; 4 mm<sup>2</sup>; 2-pole; 4,00 mm<sup>2</sup>; green-yellow, gray

[www.wago.com/769-102/000-037](http://www.wago.com/769-102/000-037)



**Item no.: 769-103**

1-conductor female plug; 4 mm<sup>2</sup>; 3-pole; 4,00 mm<sup>2</sup>; gray

[www.wago.com/769-103](http://www.wago.com/769-103)

Subject to changes. Please also observe the further product documentation!

WAGO Kontakttechnik GmbH & Co. KG

Hansastr. 27

32423 Minden

Phone: +49571 887-0 | Fax: +49571 887-169

Email: [info.de@wago.com](mailto:info.de@wago.com) | Web: [www.wago.com](http://www.wago.com)

Do you have any questions about our products?

We are always happy to take your call at +49 (571) 887-44222.



**Item no.: 769-103/000-036**

1-conductor female plug; 4 mm<sup>2</sup>; 3-pole; 4,00 mm<sup>2</sup>; gray, green-yellow

[www.wago.com/769-103/000-036](http://www.wago.com/769-103/000-036)



**Item no.: 769-103/000-037**

1-conductor female plug; 4 mm<sup>2</sup>; 3-pole; 4,00 mm<sup>2</sup>; green-yellow, gray

[www.wago.com/769-103/000-037](http://www.wago.com/769-103/000-037)



**Item no.: 769-103/000-038**

1-conductor female plug; 4 mm<sup>2</sup>; 3-pole; 4,00 mm<sup>2</sup>; gray, blue, green-yellow

[www.wago.com/769-103/000-038](http://www.wago.com/769-103/000-038)



**Item no.: 769-103/000-039**

1-conductor female plug; 4 mm<sup>2</sup>; 3-pole; 4,00 mm<sup>2</sup>; green-yellow, blue, gray

[www.wago.com/769-103/000-039](http://www.wago.com/769-103/000-039)



**Item no.: 769-104**

1-conductor female plug; 4 mm<sup>2</sup>; 4-pole; 4,00 mm<sup>2</sup>; gray

[www.wago.com/769-104](http://www.wago.com/769-104)



**Item no.: 769-104/000-036**

1-conductor female plug; 4 mm<sup>2</sup>; 4-pole; 4,00 mm<sup>2</sup>; gray, green-yellow

[www.wago.com/769-104/000-036](http://www.wago.com/769-104/000-036)



**Item no.: 769-104/000-037**

1-conductor female plug; 4 mm<sup>2</sup>; 4-pole; 4,00 mm<sup>2</sup>; green-yellow, gray

[www.wago.com/769-104/000-037](http://www.wago.com/769-104/000-037)



**Item no.: 769-104/000-038**

1-conductor female plug; 4 mm<sup>2</sup>; 4-pole; 4,00 mm<sup>2</sup>; gray, blue, green-yellow

[www.wago.com/769-104/000-038](http://www.wago.com/769-104/000-038)



**Item no.: 769-104/000-039**

1-conductor female plug; 4 mm<sup>2</sup>; 4-pole; 4,00 mm<sup>2</sup>; green-yellow, blue, gray

[www.wago.com/769-104/000-039](http://www.wago.com/769-104/000-039)



**Item no.: 769-105**

1-conductor female plug; 4 mm<sup>2</sup>; 5-pole; 4,00 mm<sup>2</sup>; gray

[www.wago.com/769-105](http://www.wago.com/769-105)



**Item no.: 769-105/000-036**

1-conductor female plug; 4 mm<sup>2</sup>; 5-pole; 4,00 mm<sup>2</sup>; gray, green-yellow

[www.wago.com/769-105/000-036](http://www.wago.com/769-105/000-036)



**Item no.: 769-105/000-037**

1-conductor female plug; 4 mm<sup>2</sup>; 5-pole; 4,00 mm<sup>2</sup>; green-yellow, gray

[www.wago.com/769-105/000-037](http://www.wago.com/769-105/000-037)



**Item no.: 769-105/000-038**

1-conductor female plug; 4 mm<sup>2</sup>; 5-pole; 4,00 mm<sup>2</sup>; gray, blue, green-yellow

[www.wago.com/769-105/000-038](http://www.wago.com/769-105/000-038)



**Item no.: 769-105/000-039**

1-conductor female plug; 4 mm<sup>2</sup>; 5-pole; 4,00 mm<sup>2</sup>; green-yellow, blue, gray

[www.wago.com/769-105/000-039](http://www.wago.com/769-105/000-039)

Subject to changes. Please also observe the further product documentation!

WAGO Kontakttechnik GmbH & Co. KG

Hansastr. 27

32423 Minden

Phone: +49571 887-0 | Fax: +49571 887-169

Email: [info.de@wago.com](mailto:info.de@wago.com) | Web: [www.wago.com](http://www.wago.com)

Do you have any questions about our products?

We are always happy to take your call at +49 (571) 887-44222.



**Item no.: 769-106**

1-conductor female plug; 4 mm²; 6-pole; 4,00 mm²; gray

[www.wago.com/769-106](http://www.wago.com/769-106)



**Item no.: 769-106/000-006**

1-conductor female plug; 4 mm²; 6-pole; 4,00 mm²; blue

[www.wago.com/769-106/000-006](http://www.wago.com/769-106/000-006)

**Item no.: 769-106/000-036**

1-conductor female plug; 4 mm²; 6-pole; 4,00 mm²; gray, green-yellow

[www.wago.com/769-106/000-036](http://www.wago.com/769-106/000-036)



**Item no.: 769-106/000-037**

1-conductor female plug; 4 mm²; 6-pole; 4,00 mm²; green-yellow, gray

[www.wago.com/769-106/000-037](http://www.wago.com/769-106/000-037)



**Item no.: 769-106/000-038**

1-conductor female plug; 4 mm²; 6-pole; 4,00 mm²; gray, blue, green-yellow

[www.wago.com/769-106/000-038](http://www.wago.com/769-106/000-038)

**Item no.: 769-106/000-039**

1-conductor female plug; 4 mm²; 6-pole; 4,00 mm²; green-yellow, blue, gray

[www.wago.com/769-106/000-039](http://www.wago.com/769-106/000-039)



**Item no.: 769-107**

1-conductor female plug; 4 mm²; 7-pole; 4,00 mm²; gray

[www.wago.com/769-107](http://www.wago.com/769-107)



**Item no.: 769-107/000-036**

1-conductor female plug; 4 mm²; 7-pole; 4,00 mm²; gray, green-yellow

[www.wago.com/769-107/000-036](http://www.wago.com/769-107/000-036)



**Item no.: 769-107/000-037**

1-conductor female plug; 4 mm²; 7-pole; 4,00 mm²; green-yellow, gray

[www.wago.com/769-107/000-037](http://www.wago.com/769-107/000-037)



**Item no.: 769-107/000-038**

1-conductor female plug; 4 mm²; 7-pole; 4,00 mm²; gray, blue, green-yellow

[www.wago.com/769-107/000-038](http://www.wago.com/769-107/000-038)



**Item no.: 769-107/000-039**

1-conductor female plug; 4 mm²; 7-pole; 4,00 mm²; green-yellow, blue, gray

[www.wago.com/769-107/000-039](http://www.wago.com/769-107/000-039)



**Item no.: 769-108**

1-conductor female plug; 4 mm²; 8-pole; 4,00 mm²; gray

[www.wago.com/769-108](http://www.wago.com/769-108)



**Item no.: 769-108/000-036**

1-conductor female plug; 4 mm²; 8-pole; 4,00 mm²; gray, green-yellow

[www.wago.com/769-108/000-036](http://www.wago.com/769-108/000-036)

**Item no.: 769-108/000-037**

1-conductor female plug; 4 mm²; 8-pole; 4,00 mm²; green-yellow, gray

[www.wago.com/769-108/000-037](http://www.wago.com/769-108/000-037)

Subject to changes. Please also observe the further product documentation!



**Item no.: 769-108/000-038**

1-conductor female plug; 4 mm<sup>2</sup>; 8-pole; 4,00 mm<sup>2</sup>; gray, blue, green-yellow

[www.wago.com/769-108/000-038](http://www.wago.com/769-108/000-038)



**Item no.: 769-108/000-039**

1-conductor female plug; 4 mm<sup>2</sup>; 8-pole; 4,00 mm<sup>2</sup>; green-yellow, blue, gray

[www.wago.com/769-108/000-039](http://www.wago.com/769-108/000-039)



**Item no.: 769-109**

1-conductor female plug; 4 mm<sup>2</sup>; 9-pole; 4,00 mm<sup>2</sup>; gray

[www.wago.com/769-109](http://www.wago.com/769-109)



**Item no.: 769-109/000-036**

1-conductor female plug; 4 mm<sup>2</sup>; 9-pole; 4,00 mm<sup>2</sup>; gray, green-yellow

[www.wago.com/769-109/000-036](http://www.wago.com/769-109/000-036)



**Item no.: 769-109/000-037**

1-conductor female plug; 4 mm<sup>2</sup>; 9-pole; 4,00 mm<sup>2</sup>; green-yellow, gray

[www.wago.com/769-109/000-037](http://www.wago.com/769-109/000-037)



**Item no.: 769-109/000-038**

1-conductor female plug; 4 mm<sup>2</sup>; 9-pole; 4,00 mm<sup>2</sup>; gray, blue, green-yellow

[www.wago.com/769-109/000-038](http://www.wago.com/769-109/000-038)



**Item no.: 769-109/000-039**

1-conductor female plug; 4 mm<sup>2</sup>; 9-pole; 4,00 mm<sup>2</sup>; green-yellow, blue, gray

[www.wago.com/769-109/000-039](http://www.wago.com/769-109/000-039)



**Item no.: 769-110**

1-conductor female plug; 4 mm<sup>2</sup>; 10-pole; 4,00 mm<sup>2</sup>; gray

[www.wago.com/769-110](http://www.wago.com/769-110)



**Item no.: 769-110/000-036**

1-conductor female plug; 4 mm<sup>2</sup>; 10-pole; 4,00 mm<sup>2</sup>; gray, green-yellow

[www.wago.com/769-110/000-036](http://www.wago.com/769-110/000-036)



**Item no.: 769-110/000-037**

1-conductor female plug; 4 mm<sup>2</sup>; 10-pole; 4,00 mm<sup>2</sup>; green-yellow, gray

[www.wago.com/769-110/000-037](http://www.wago.com/769-110/000-037)



**Item no.: 769-110/000-038**

1-conductor female plug; 4 mm<sup>2</sup>; 10-pole; 4,00 mm<sup>2</sup>; gray, blue, green-yellow

[www.wago.com/769-110/000-038](http://www.wago.com/769-110/000-038)



**Item no.: 769-110/000-039**

1-conductor female plug; 4 mm<sup>2</sup>; 10-pole; 4,00 mm<sup>2</sup>; green-yellow, blue, gray

[www.wago.com/769-110/000-039](http://www.wago.com/769-110/000-039)



**Item no.: 769-111**

1-conductor female plug; 4 mm<sup>2</sup>; 11-pole; 4,00 mm<sup>2</sup>; gray

[www.wago.com/769-111](http://www.wago.com/769-111)



**Item no.: 769-111/000-036**

1-conductor female plug; 4 mm<sup>2</sup>; 11-pole; 4,00 mm<sup>2</sup>; gray, green-yellow

[www.wago.com/769-111/000-036](http://www.wago.com/769-111/000-036)

Subject to changes. Please also observe the further product documentation!

WAGO Kontakttechnik GmbH & Co. KG

Hansastr. 27















32423 Minden

Phone: +49571 887-0 | Fax: +49571 887-169

Email: [info.de@wago.com](mailto:info.de@wago.com) | Web: [www.wago.com](http://www.wago.com)

Do you have any questions about our products?

We are always happy to take your call at +49 (571) 887-44222.

	<p><b>Item no.: 769-111/000-037</b>                      1-conductor female plug; 4 mm<sup>2</sup>; 11-pole; 4,00 mm<sup>2</sup>; green-yellow, gray</p>	<a href="http://www.wago.com/769-111/000-037">www.wago.com/769-111/000-037</a>
	<p><b>Item no.: 769-111/000-038</b>                      1-conductor female plug; 4 mm<sup>2</sup>; 11-pole; 4,00 mm<sup>2</sup>; gray, blue, green-yellow</p>	<a href="http://www.wago.com/769-111/000-038">www.wago.com/769-111/000-038</a>
	<p><b>Item no.: 769-111/000-039</b>                      1-conductor female plug; 4 mm<sup>2</sup>; 11-pole; 4,00 mm<sup>2</sup>; green-yellow, blue, gray</p>	<a href="http://www.wago.com/769-111/000-039">www.wago.com/769-111/000-039</a>
	<p><b>Item no.: 769-112/000-036</b>                      1-conductor female plug; 4 mm<sup>2</sup>; 12-pole; 4,00 mm<sup>2</sup>; gray, green-yellow</p>	<a href="http://www.wago.com/769-112/000-036">www.wago.com/769-112/000-036</a>
	<p><b>Item no.: 769-112/000-037</b>                      1-conductor female plug; 4 mm<sup>2</sup>; 12-pole; 4,00 mm<sup>2</sup>; green-yellow, gray</p>	<a href="http://www.wago.com/769-112/000-037">www.wago.com/769-112/000-037</a>
	<p><b>Item no.: 769-112/000-038</b>                      1-conductor female plug; 4 mm<sup>2</sup>; 12-pole; 4,00 mm<sup>2</sup>; gray, blue, green-yellow</p>	<a href="http://www.wago.com/769-112/000-038">www.wago.com/769-112/000-038</a>
	<p><b>Item no.: 769-112/000-039</b>                      1-conductor female plug; 4 mm<sup>2</sup>; 12-pole; 4,00 mm<sup>2</sup>; green-yellow, blue, gray</p>	<a href="http://www.wago.com/769-112/000-039">www.wago.com/769-112/000-039</a>
	<p><b>Item no.: 769-121</b>                      2-conductor female connector; 4 mm<sup>2</sup>; 1-pole; 4,00 mm<sup>2</sup>; gray</p>	<a href="http://www.wago.com/769-121">www.wago.com/769-121</a>
	<p><b>Item no.: 769-122</b>                      2-conductor female connector; 4 mm<sup>2</sup>; 2-pole; 4,00 mm<sup>2</sup>; gray</p>	<a href="http://www.wago.com/769-122">www.wago.com/769-122</a>
	<p><b>Item no.: 769-123</b>                      2-conductor female connector; 4 mm<sup>2</sup>; 3-pole; 4,00 mm<sup>2</sup>; gray</p>	<a href="http://www.wago.com/769-123">www.wago.com/769-123</a>
	<p><b>Item no.: 769-124</b>                      2-conductor female connector; 4 mm<sup>2</sup>; 4-pole; 4,00 mm<sup>2</sup>; gray</p>	<a href="http://www.wago.com/769-124">www.wago.com/769-124</a>
	<p><b>Item no.: 769-125</b>                      2-conductor female connector; 4 mm<sup>2</sup>; 5-pole; 4,00 mm<sup>2</sup>; gray</p>	<a href="http://www.wago.com/769-125">www.wago.com/769-125</a>
	<p><b>Item no.: 769-126</b>                      2-conductor female connector; 4 mm<sup>2</sup>; 6-pole; 4,00 mm<sup>2</sup>; gray</p>	<a href="http://www.wago.com/769-126">www.wago.com/769-126</a>
	<p><b>Item no.: 769-127</b>                      2-conductor female connector; 4 mm<sup>2</sup>; 7-pole; 4,00 mm<sup>2</sup>; gray</p>	<a href="http://www.wago.com/769-127">www.wago.com/769-127</a>
	<p><b>Item no.: 769-128</b>                      2-conductor female connector; 4 mm<sup>2</sup>; 8-pole; 4,00 mm<sup>2</sup>; gray</p>	<a href="http://www.wago.com/769-128">www.wago.com/769-128</a>

Subject to changes. Please also observe the further product documentation!





**Item no.: 769-129**  
2-conductor female connector; 4 mm²; 9-pole; 4,00 mm²; gray

[www.wago.com/769-129](http://www.wago.com/769-129)



**Item no.: 769-130**  
2-conductor female connector; 4 mm²; 10-pole; 4,00 mm²; gray

[www.wago.com/769-130](http://www.wago.com/769-130)



**Item no.: 769-131**  
2-conductor female connector; 4 mm²; 11-pole; 4,00 mm²; gray

[www.wago.com/769-131](http://www.wago.com/769-131)



**Item no.: 769-133**  
2-conductor female connector; 4 mm²; 13-pole; 4,00 mm²; gray

[www.wago.com/769-133](http://www.wago.com/769-133)

#### Marking accessories



**Item no.: 210-831**  
Marking strips; on reel; 2.3 mm wide; plain; Self-adhesive; white

[www.wago.com/210-831](http://www.wago.com/210-831)



**Item no.: 210-832**  
Marking strips; on reel; 3 mm wide; plain; Self-adhesive; white

[www.wago.com/210-832](http://www.wago.com/210-832)

**Item no.: 210-833**  
Marking strips; on reel; 6 mm wide; plain; Self-adhesive; white

[www.wago.com/210-833](http://www.wago.com/210-833)

**Item no.: 210-834**  
Marking strips; on reel; 5 mm wide; plain; Self-adhesive; white

[www.wago.com/210-834](http://www.wago.com/210-834)

#### Downloads

##### Documentation

##### Additional Information

Technical explanations	Apr 3, 2019	pdf 2.1 MB	Download
------------------------	-------------	---------------	----------

#### CAD/CAE-Data

##### CAD data

2D/3D Models 769-642	URL	Download
----------------------	-----	----------

##### PCB Design

Symbol and Footprint 769-642	URL	Download
------------------------------	-----	----------

CAx data for your PCB design, consisting of "schematic symbols and PCB footprints", allow easy integration of the WAGO component into your development environment.

##### Supported formats:

- Accel EDA 14 & 15
- Altium 6 to current version

Subject to changes. Please also observe the further product documentation!



- Cadence Allegro
- DesignSpark
- Eagle Libraries
- KiCad
- Mentor Graphics BoardStation
- Mentor Graphics Design Architect
- Mentor Graphics Design Expedition 99 and 2000
- OrCAD 9.X PCB and Capture
- PADS PowerPCB 3, 3.5, 4.X, and 5.X
- PADS PowerPCB and PowerLogic 3.0
- PCAD 2000, 2001, 2002, 2004, and 2006
- Pulsonix 8.5 or newer
- STL
- 3D STEP
- TARGET 3001!
- View Logic ViewDraw
- Quadcept
- Zuken CadStar 3 and 4
- Zuken CR-5000 and CR-8000

PCB Component Libraries (EDA), PCB CAD Library Ultra Librarian

---

## Installation Notes

### Assembly

Subject to changes. Please also observe the further product documentation!

---

WAGO Kontakttechnik GmbH & Co. KG  
Hansastr. 27  
32423 Minden  
Phone: +49571 887-0 | Fax: +49571 887-169  
Email: [info.de@wago.com](mailto:info.de@wago.com) | Web: [www.wago.com](http://www.wago.com)

Do you have any questions about our products?  
We are always happy to take your call at +49 (571) 887-44222.

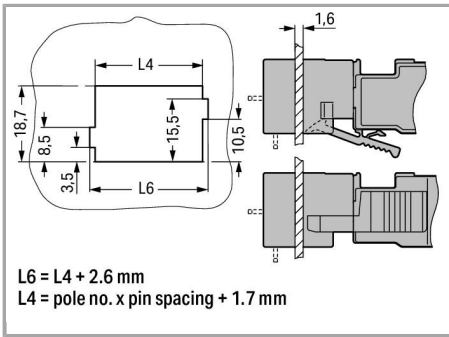

Cutout

Male headers with solder pins

Application

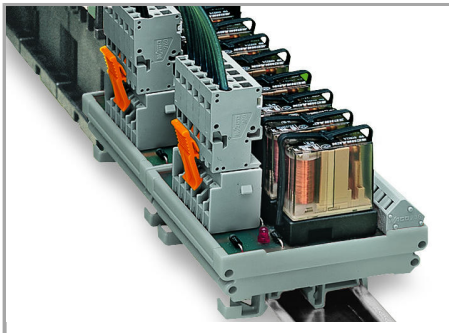

Male headers with straight solder pins and 1-conductor female plugs (picture shows a relay module)

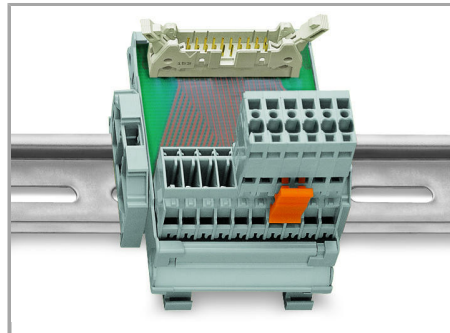

Male headers with solder pins for printed circuit boards

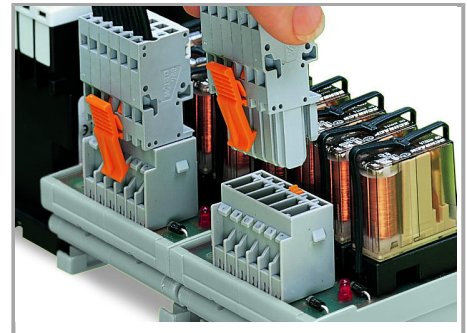

Pluggable PCB connection

Connection to a relay module inside the switchgear cabinet

Subject to changes. Please also observe the further product documentation!

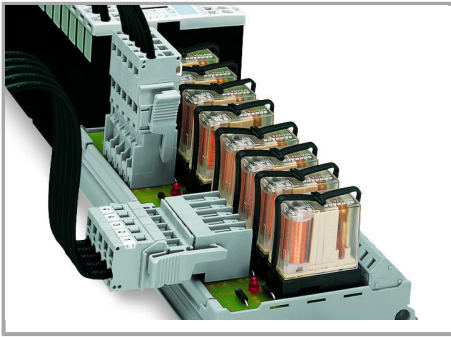

Male headers with solder pins:

Integrating PCB components into the system wiring.

## Product family

### X-COM

[Learn more about the product family.](#)

[Show all products from the family](#)

Subject to changes. Please also observe the further product documentation!