

**Data sheet | Item number: 769-637**

THT male header; 1.0 x 1.0 mm solder pin; straight; Pin spacing 5 mm; 7-pole; gray

[www.wago.com/769-637](http://www.wago.com/769-637)

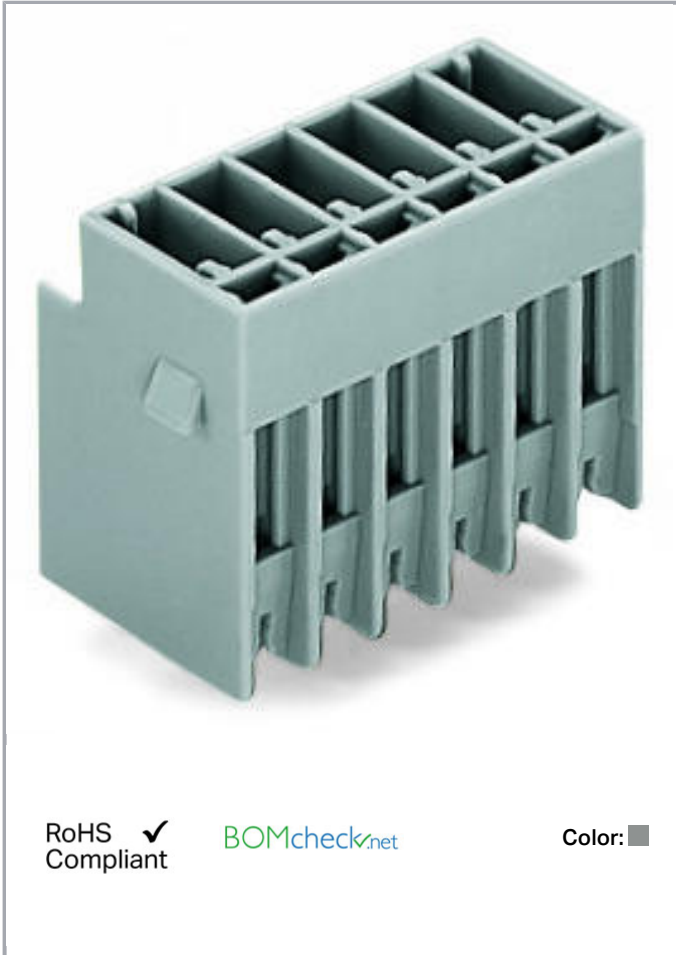

**Data**

**Electrical data**

**Ratings per IEC/EN 60664-1**

Rated voltage (III / 3)	250 V
Rated impulse voltage (III / 3)	4 kV
Rated voltage (III / 2)	500 V
Rated impulse voltage (III / 2)	4 kV
Rated current	32 A

Subject to changes. Please also observe the further product documentation!

WAGO Kontakttechnik GmbH & Co. KG  
Hansastr. 27  
32423 Minden  
Phone: +49571 887-0 | Fax: +49571 887-169  
Email: [info.de@wago.com](mailto:info.de@wago.com) | Web: [www.wago.com](http://www.wago.com)

Do you have any questions about our products?  
We are always happy to take your call at +49 (571) 887-44222.

Legend (ratings)

(III / 3) ≙ Overvoltage category III / Pollution degree 3

### Connection data

No. of poles	7
Total number of potentials	7
Number of levels	1

### Geometrical Data

Pin spacing	5 mm / 0.197 inch
Width	38.6 mm / 1.52 inch
Height from the surface	22.2 mm / 0.874 inch
Depth	18.3 mm / 0.72 inch

### Plug connection

Contact type (pluggable connector)	Male connector/plug
Connector connection type	for PCBs
Mismating protection	No
Mating direction to the PCB	90°

### PCB contact

PCB contact	THT
-------------	-----

### Material Data

Color	gray
Insulating material	Polyamide 66 (PA 66)
Fire load	0.158 MJ
Weight	7.3 g

### Commercial data

Product Group	18 (X-COM-System)
Packaging type	BOX
Country of origin	PL
GTIN	4044918761819
Customs Tariff No.	85366990990





### Approvals / Certificates

Subject to changes. Please also observe the further product documentation!

WAGO Kontakttechnik GmbH & Co. KG  
 Hansastr. 27  
 32423 Minden  
 Phone: +49571 887-0 | Fax: +49571 887-169  
 Email: [info.de@wago.com](mailto:info.de@wago.com) | Web: [www.wago.com](http://www.wago.com)

Do you have any questions about our products?  
 We are always happy to take your call at +49 (571) 887-44222.



## Country specific Approvals

Logo	Approval	Additional Approval Text	Certificate name
	CCA DEKRA Certification B.V.	EN 60947	NTR NL-7626
	CCA DEKRA Certification B.V.	EN 61984	2190419.02
	CCA DEKRA Certification B.V.	IEC 61984	NL-47799 /A1
	CSA DEKRA Certification B.V.	C22.2 No. 158	1101144
	KEMA/KEUR DEKRA Certification B.V.	EN 60947	2190419.01

## Ship Approvals

Logo	Approval	Additional Approval Text	Certificate name
	DNV GL Det Norske Veritas, Germanischer Lloyd	-	TAE00001V2

## UL-Approvals

Logo	Approval	Additional Approval Text	Certificate name
	UR Underwriters Laboratories Inc.	UL 1977	20151210-E45171
	UR Underwriters Laboratories Inc.	UL 1059	20190731-E45172

Subject to changes. Please also observe the further product documentation!

## Counterpart



**Item no.769-107**

1-conductor female plug; 4 mm<sup>2</sup>; 7-pole; 4,00 mm<sup>2</sup>; gray

[www.wago.com/769-107](http://www.wago.com/769-107)



**Item no.769-107/021-000**

1-conductor female plug; Locking lever; 4 mm<sup>2</sup>; 7-pole; 4,00 mm<sup>2</sup>; gray

[www.wago.com/769-107/021-000](http://www.wago.com/769-107/021-000)



**Item no.769-127**

2-conductor female connector; 4 mm<sup>2</sup>; 7-pole; 4,00 mm<sup>2</sup>; gray

[www.wago.com/769-127](http://www.wago.com/769-127)

## Compatible products

### Female plug

**Item no.: 769-101**

1-conductor female plug; 4 mm<sup>2</sup>; 1-pole; 4,00 mm<sup>2</sup>; gray

[www.wago.com/769-101](http://www.wago.com/769-101)



**Item no.: 769-102**

1-conductor female plug; 4 mm<sup>2</sup>; 2-pole; 4,00 mm<sup>2</sup>; gray

[www.wago.com/769-102](http://www.wago.com/769-102)



**Item no.: 769-102/000-036**

1-conductor female plug; 4 mm<sup>2</sup>; 2-pole; 4,00 mm<sup>2</sup>; gray, green-yellow

[www.wago.com/769-102/000-036](http://www.wago.com/769-102/000-036)



**Item no.: 769-102/000-037**

1-conductor female plug; 4 mm<sup>2</sup>; 2-pole; 4,00 mm<sup>2</sup>; green-yellow, gray

[www.wago.com/769-102/000-037](http://www.wago.com/769-102/000-037)



**Item no.: 769-103**

1-conductor female plug; 4 mm<sup>2</sup>; 3-pole; 4,00 mm<sup>2</sup>; gray

[www.wago.com/769-103](http://www.wago.com/769-103)



**Item no.: 769-103/000-036**

1-conductor female plug; 4 mm<sup>2</sup>; 3-pole; 4,00 mm<sup>2</sup>; gray, green-yellow

[www.wago.com/769-103/000-036](http://www.wago.com/769-103/000-036)

Subject to changes. Please also observe the further product documentation!

WAGO Kontakttechnik GmbH & Co. KG

Hansastr. 27













32423 Minden

Phone: +49571 887-0 | Fax: +49571 887-169

Email: [info.de@wago.com](mailto:info.de@wago.com) | Web: [www.wago.com](http://www.wago.com)

Do you have any questions about our products?

We are always happy to take your call at +49 (571) 887-44222.

	<b>Item no.: 769-103/000-037</b> 1-conductor female plug; 4 mm <sup>2</sup> ; 3-pole; 4,00 mm <sup>2</sup> ; green-yellow, gray	<a href="http://www.wago.com/769-103/000-037">www.wago.com/769-103/000-037</a>
	<b>Item no.: 769-103/000-038</b> 1-conductor female plug; 4 mm <sup>2</sup> ; 3-pole; 4,00 mm <sup>2</sup> ; gray, blue, green-yellow	<a href="http://www.wago.com/769-103/000-038">www.wago.com/769-103/000-038</a>
	<b>Item no.: 769-103/000-039</b> 1-conductor female plug; 4 mm <sup>2</sup> ; 3-pole; 4,00 mm <sup>2</sup> ; green-yellow, blue, gray	<a href="http://www.wago.com/769-103/000-039">www.wago.com/769-103/000-039</a>
	<b>Item no.: 769-104</b> 1-conductor female plug; 4 mm <sup>2</sup> ; 4-pole; 4,00 mm <sup>2</sup> ; gray	<a href="http://www.wago.com/769-104">www.wago.com/769-104</a>
	<b>Item no.: 769-104/000-036</b> 1-conductor female plug; 4 mm <sup>2</sup> ; 4-pole; 4,00 mm <sup>2</sup> ; gray, green-yellow	<a href="http://www.wago.com/769-104/000-036">www.wago.com/769-104/000-036</a>
	<b>Item no.: 769-104/000-037</b> 1-conductor female plug; 4 mm <sup>2</sup> ; 4-pole; 4,00 mm <sup>2</sup> ; green-yellow, gray	<a href="http://www.wago.com/769-104/000-037">www.wago.com/769-104/000-037</a>
	<b>Item no.: 769-104/000-038</b> 1-conductor female plug; 4 mm <sup>2</sup> ; 4-pole; 4,00 mm <sup>2</sup> ; gray, blue, green-yellow	<a href="http://www.wago.com/769-104/000-038">www.wago.com/769-104/000-038</a>
	<b>Item no.: 769-104/000-039</b> 1-conductor female plug; 4 mm <sup>2</sup> ; 4-pole; 4,00 mm <sup>2</sup> ; green-yellow, blue, gray	<a href="http://www.wago.com/769-104/000-039">www.wago.com/769-104/000-039</a>
	<b>Item no.: 769-105</b> 1-conductor female plug; 4 mm <sup>2</sup> ; 5-pole; 4,00 mm <sup>2</sup> ; gray	<a href="http://www.wago.com/769-105">www.wago.com/769-105</a>
	<b>Item no.: 769-105/000-036</b> 1-conductor female plug; 4 mm <sup>2</sup> ; 5-pole; 4,00 mm <sup>2</sup> ; gray, green-yellow	<a href="http://www.wago.com/769-105/000-036">www.wago.com/769-105/000-036</a>
	<b>Item no.: 769-105/000-037</b> 1-conductor female plug; 4 mm <sup>2</sup> ; 5-pole; 4,00 mm <sup>2</sup> ; green-yellow, gray	<a href="http://www.wago.com/769-105/000-037">www.wago.com/769-105/000-037</a>
	<b>Item no.: 769-105/000-038</b> 1-conductor female plug; 4 mm <sup>2</sup> ; 5-pole; 4,00 mm <sup>2</sup> ; gray, blue, green-yellow	<a href="http://www.wago.com/769-105/000-038">www.wago.com/769-105/000-038</a>
	<b>Item no.: 769-105/000-039</b> 1-conductor female plug; 4 mm <sup>2</sup> ; 5-pole; 4,00 mm <sup>2</sup> ; green-yellow, blue, gray	<a href="http://www.wago.com/769-105/000-039">www.wago.com/769-105/000-039</a>
	<b>Item no.: 769-106</b> 1-conductor female plug; 4 mm <sup>2</sup> ; 6-pole; 4,00 mm <sup>2</sup> ; gray	<a href="http://www.wago.com/769-106">www.wago.com/769-106</a>

Subject to changes. Please also observe the further product documentation!



**Item no.: 769-106/000-006**  
1-conductor female plug; 4 mm<sup>2</sup>; 6-pole; 4,00 mm<sup>2</sup>; blue

[www.wago.com/769-106/000-006](http://www.wago.com/769-106/000-006)

**Item no.: 769-106/000-036**  
1-conductor female plug; 4 mm<sup>2</sup>; 6-pole; 4,00 mm<sup>2</sup>; gray, green-yellow

[www.wago.com/769-106/000-036](http://www.wago.com/769-106/000-036)



**Item no.: 769-106/000-037**  
1-conductor female plug; 4 mm<sup>2</sup>; 6-pole; 4,00 mm<sup>2</sup>; green-yellow, gray

[www.wago.com/769-106/000-037](http://www.wago.com/769-106/000-037)



**Item no.: 769-106/000-038**  
1-conductor female plug; 4 mm<sup>2</sup>; 6-pole; 4,00 mm<sup>2</sup>; gray, blue, green-yellow

[www.wago.com/769-106/000-038](http://www.wago.com/769-106/000-038)

**Item no.: 769-106/000-039**  
1-conductor female plug; 4 mm<sup>2</sup>; 6-pole; 4,00 mm<sup>2</sup>; green-yellow, blue, gray

[www.wago.com/769-106/000-039](http://www.wago.com/769-106/000-039)



**Item no.: 769-107/000-036**  
1-conductor female plug; 4 mm<sup>2</sup>; 7-pole; 4,00 mm<sup>2</sup>; gray, green-yellow

[www.wago.com/769-107/000-036](http://www.wago.com/769-107/000-036)



**Item no.: 769-107/000-037**  
1-conductor female plug; 4 mm<sup>2</sup>; 7-pole; 4,00 mm<sup>2</sup>; green-yellow, gray

[www.wago.com/769-107/000-037](http://www.wago.com/769-107/000-037)



**Item no.: 769-107/000-038**  
1-conductor female plug; 4 mm<sup>2</sup>; 7-pole; 4,00 mm<sup>2</sup>; gray, blue, green-yellow

[www.wago.com/769-107/000-038](http://www.wago.com/769-107/000-038)



**Item no.: 769-107/000-039**  
1-conductor female plug; 4 mm<sup>2</sup>; 7-pole; 4,00 mm<sup>2</sup>; green-yellow, blue, gray

[www.wago.com/769-107/000-039](http://www.wago.com/769-107/000-039)



**Item no.: 769-121**  
2-conductor female connector; 4 mm<sup>2</sup>; 1-pole; 4,00 mm<sup>2</sup>; gray

[www.wago.com/769-121](http://www.wago.com/769-121)



**Item no.: 769-122**  
2-conductor female connector; 4 mm<sup>2</sup>; 2-pole; 4,00 mm<sup>2</sup>; gray

[www.wago.com/769-122](http://www.wago.com/769-122)



**Item no.: 769-123**  
2-conductor female connector; 4 mm<sup>2</sup>; 3-pole; 4,00 mm<sup>2</sup>; gray

[www.wago.com/769-123](http://www.wago.com/769-123)



**Item no.: 769-124**  
2-conductor female connector; 4 mm<sup>2</sup>; 4-pole; 4,00 mm<sup>2</sup>; gray

[www.wago.com/769-124](http://www.wago.com/769-124)

**Item no.: 769-125**  
2-conductor female connector; 4 mm<sup>2</sup>; 5-pole; 4,00 mm<sup>2</sup>; gray

[www.wago.com/769-125](http://www.wago.com/769-125)





**Item no.: 769-126**  
2-conductor female connector; 4 mm<sup>2</sup>; 6-pole; 4,00 mm<sup>2</sup>; gray

[www.wago.com/769-126](http://www.wago.com/769-126)

#### Marking accessories

Subject to changes. Please also observe the further product documentation!



	<b>Item no.: 210-831</b> Marking strips; on reel; 2.3 mm wide; plain; Self-adhesive; white	<a href="http://www.wago.com/210-831">www.wago.com/210-831</a>
	<b>Item no.: 210-832</b> Marking strips; on reel; 3 mm wide; plain; Self-adhesive; white	<a href="http://www.wago.com/210-832">www.wago.com/210-832</a>
	<b>Item no.: 210-833</b> Marking strips; on reel; 6 mm wide; plain; Self-adhesive; white	<a href="http://www.wago.com/210-833">www.wago.com/210-833</a>
	<b>Item no.: 210-834</b> Marking strips; on reel; 5 mm wide; plain; Self-adhesive; white	<a href="http://www.wago.com/210-834">www.wago.com/210-834</a>
<b>Coding</b>		
	<b>Item no.: 769-435</b> Coding pin; for coding of female plugs; for carrier terminal blocks / male connectors; orange	<a href="http://www.wago.com/769-435">www.wago.com/769-435</a>

## Downloads

### Documentation

#### Additional Information

Technical explanations	Apr 3, 2019	pdf 2.1 MB	Download
------------------------	-------------	---------------	----------

## CAD/CAE-Data

### CAD data

2D/3D Models 769-637	URL	Download
----------------------	-----	----------

### PCB Design

Symbol and Footprint 769-637	URL	Download
------------------------------	-----	----------

CAX data for your PCB design, consisting of "schematic symbols and PCB footprints", allow easy integration of the WAGO component into your development environment.

### Supported formats:

- Accel EDA 14 & 15
- Altium 6 to current version
- Cadence Allegro
- DesignSpark
- Eagle Libraries
- KiCad
- Mentor Graphics BoardStation
- Mentor Graphics Design Architect

Subject to changes. Please also observe the further product documentation!

- Mentor Graphics Design Expedition 99 and 2000
- OrCAD 9.X PCB and Capture
- PADS PowerPCB 3, 3.5, 4.X, and 5.X
- PADS PowerPCB and PowerLogic 3.0
- PCAD 2000, 2001, 2002, 2004, and 2006
- Pulsonix 8.5 or newer
- STL
- 3D STEP
- TARGET 3001!
- View Logic ViewDraw
- Quadcept
- Zuken CadStar 3 and 4
- Zuken CR-5000 and CR-8000

PCB Component Libraries (EDA), PCB CAD Library Ultra Librarian

---

## Installation Notes

### Assembly

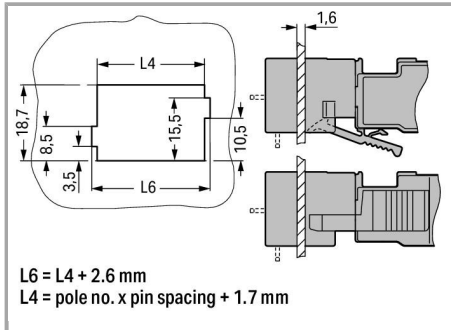

Cutout

Male headers with solder pins

### Application

Subject to changes. Please also observe the further product documentation!



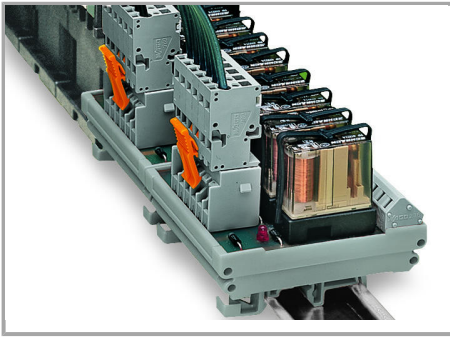

Male headers with straight solder pins and 1-conductor female plugs (picture shows a relay module)

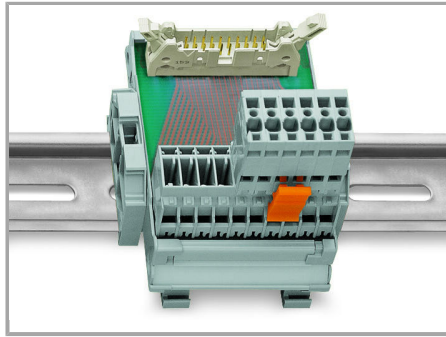

Male headers with solder pins for printed circuit boards

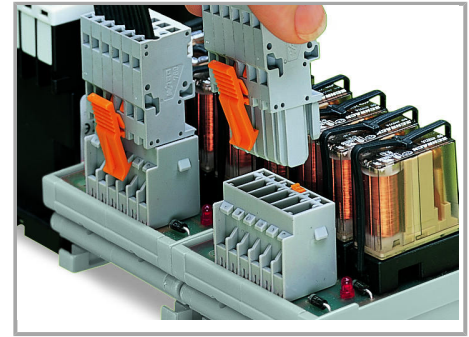

Pluggable PCB connection

Connection to a relay module inside the switchgear cabinet

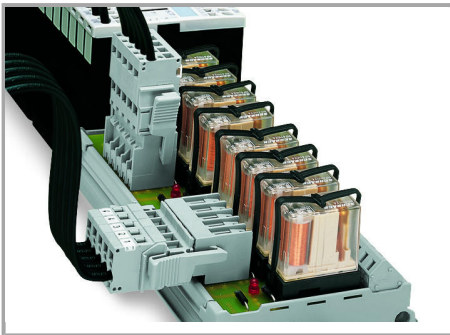

Male headers with solder pins:

Integrating PCB components into the system wiring.

## Product family

### X-COM

[Learn more about the product family.](#)

[Show all products from the family](#)

Subject to changes. Please also observe the further product documentation!