

## Data sheet | Item number: 769-636/003-036

THT male header; 1.0 x 1.0 mm solder pin; straight; Pin spacing 5 mm; 6-pole; gray

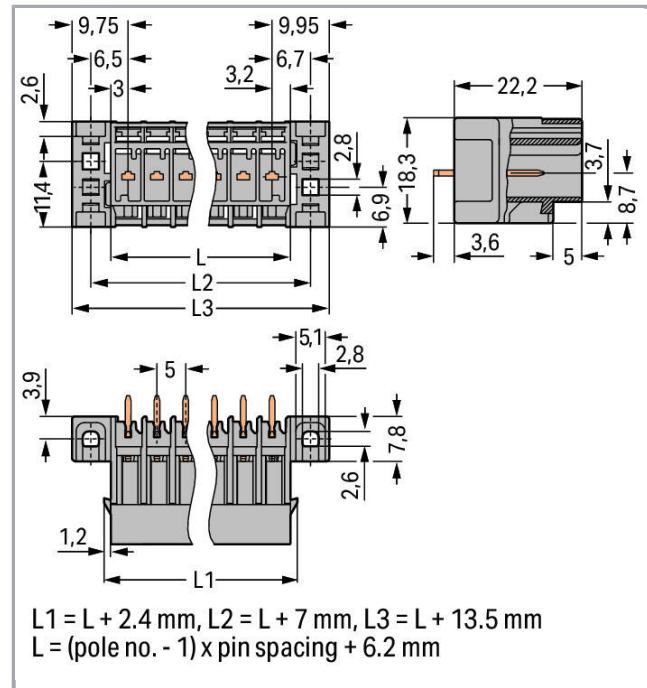

[www.wago.com/769-636/003-036](http://www.wago.com/769-636/003-036)

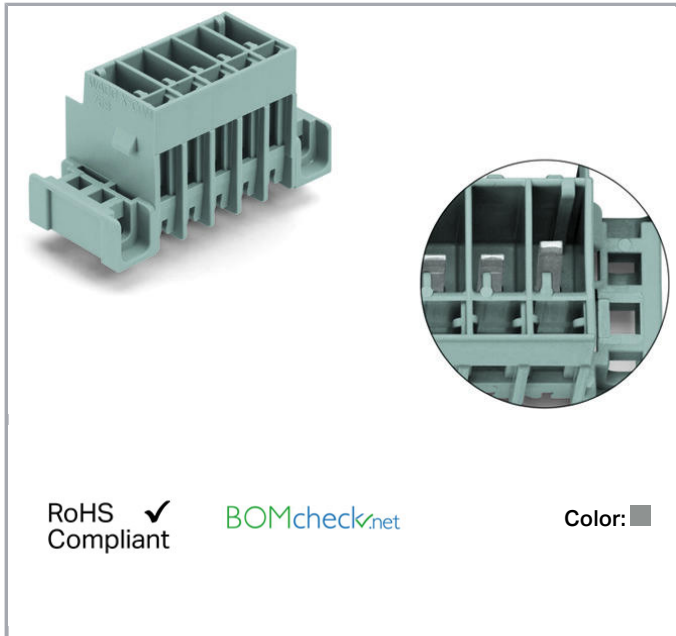

### Data

#### Electrical data

#### Ratings per IEC/EN 60664-1

Rated voltage (III / 3)	250 V
Rated impulse voltage (III / 3)	4 kV
Rated voltage (III / 2)	500 V
Rated impulse voltage (III / 2)	4 kV
Rated current	32 A
Legend (ratings)	(III / 3) ≙ Overvoltage category III / Pollution degree 3

#### Connection data

No. of poles	6
Total number of potentials	6
Number of levels	1

Subject to changes. Please also observe the further product documentation!

WAGO Kontakttechnik GmbH & Co. KG  
Hansastr. 27  
32423 Minden  
Phone: +49571 887-0 | Fax: +49571 887-169  
Email: [info.de@wago.com](mailto:info.de@wago.com) | Web: [www.wago.com](http://www.wago.com)

Do you have any questions about our products?  
We are always happy to take your call at +49 (571) 887-44222.



## Geometrical Data

Pin spacing	5 mm / 0.197 inch
Width	44.7 mm / 1.76 inch
Height from the surface	22.2 mm / 0.874 inch
Depth	18.3 mm / 0.72 inch

## Mechanical data

Mounting type	Mounting flange
---------------	-----------------

## Plug connection

Contact type (pluggable connector)	Male connector/plug
Connector connection type	for PCBs
Mismating protection	No
Mating direction to the PCB	90°

## PCB contact

PCB contact	THT
-------------	-----

## Material Data

Color	gray
Insulating material	Polyamide 66 (PA 66)
Fire load	0.16 MJ
Weight	7.2 g

## Commercial data

Product Group	18 (X-COM-System)
Packaging type	BOX
Country of origin	PL
GTIN	4050821272717
Customs Tariff No.	85366990990

## Approvals / Certificates

### Country specific Approvals

Logo	Approval	Additional Approval Text	Certificate name
	CSA	C22.2 No. 158	1101144

Subject to changes. Please also observe the further product documentation!



WAGO Kontakttechnik GmbH & Co. KG  
 Hansastr. 27  
 32423 Minden  
 Phone: +49571 887-0 | Fax: +49571 887-169  
 Email: [info.de@wago.com](mailto:info.de@wago.com) | Web: [www.wago.com](http://www.wago.com)

Do you have any questions about our products?  
 We are always happy to take your call at +49 (571) 887-44222.



DEKRA Certification B.V.

### UL-Approvals

Logo	Approval	Additional Approval Text	Certificate name
	UR Underwriters Laboratories Inc.	UL 1977	20151210-E45171
	UR Underwriters Laboratories Inc.	UL 1059	20190731-E45172

### Counterpart



Item no.769-106

1-conductor female plug; 4 mm<sup>2</sup>; 6-pole; 4,00 mm<sup>2</sup>; gray

[www.wago.com/769-106](http://www.wago.com/769-106)



Item no.769-106/021-000

1-conductor female plug; Locking lever; 4 mm<sup>2</sup>; 6-pole; 4,00 mm<sup>2</sup>; gray

[www.wago.com/769-106/021-000](http://www.wago.com/769-106/021-000)



Item no.769-126

2-conductor female connector; 4 mm<sup>2</sup>; 6-pole; 4,00 mm<sup>2</sup>; gray

[www.wago.com/769-126](http://www.wago.com/769-126)

### Compatible products

#### Coding



Item no.: 769-435

Coding pin; for coding of female plugs; for carrier terminal blocks / male connectors; orange

[www.wago.com/769-435](http://www.wago.com/769-435)

Subject to changes. Please also observe the further product documentation!

WAGO Kontakttechnik GmbH & Co. KG

Hansastr. 27

32423 Minden









Phone: +49571 887-0 | Fax: +49571 887-169

Email: [info.de@wago.com](mailto:info.de@wago.com) | Web: [www.wago.com](http://www.wago.com)

Do you have any questions about our products?

We are always happy to take your call at +49 (571) 887-44222.

Female plug

	<b>Item no.: 769-101</b> 1-conductor female plug; 4 mm <sup>2</sup> ; 1-pole; 4,00 mm <sup>2</sup> ; gray	<a href="http://www.wago.com/769-101">www.wago.com/769-101</a>
	<b>Item no.: 769-102</b> 1-conductor female plug; 4 mm <sup>2</sup> ; 2-pole; 4,00 mm <sup>2</sup> ; gray	<a href="http://www.wago.com/769-102">www.wago.com/769-102</a>
	<b>Item no.: 769-102/000-036</b> 1-conductor female plug; 4 mm <sup>2</sup> ; 2-pole; 4,00 mm <sup>2</sup> ; gray, green-yellow	<a href="http://www.wago.com/769-102/000-036">www.wago.com/769-102/000-036</a>
	<b>Item no.: 769-102/000-037</b> 1-conductor female plug; 4 mm <sup>2</sup> ; 2-pole; 4,00 mm <sup>2</sup> ; green-yellow, gray	<a href="http://www.wago.com/769-102/000-037">www.wago.com/769-102/000-037</a>
	<b>Item no.: 769-106/000-006</b> 1-conductor female plug; 4 mm <sup>2</sup> ; 6-pole; 4,00 mm <sup>2</sup> ; blue	<a href="http://www.wago.com/769-106/000-006">www.wago.com/769-106/000-006</a>
	<b>Item no.: 769-106/000-036</b> 1-conductor female plug; 4 mm <sup>2</sup> ; 6-pole; 4,00 mm <sup>2</sup> ; gray, green-yellow	<a href="http://www.wago.com/769-106/000-036">www.wago.com/769-106/000-036</a>
	<b>Item no.: 769-106/000-037</b> 1-conductor female plug; 4 mm <sup>2</sup> ; 6-pole; 4,00 mm <sup>2</sup> ; green-yellow, gray	<a href="http://www.wago.com/769-106/000-037">www.wago.com/769-106/000-037</a>
	<b>Item no.: 769-106/000-038</b> 1-conductor female plug; 4 mm <sup>2</sup> ; 6-pole; 4,00 mm <sup>2</sup> ; gray, blue, green-yellow	<a href="http://www.wago.com/769-106/000-038">www.wago.com/769-106/000-038</a>
	<b>Item no.: 769-106/000-039</b> 1-conductor female plug; 4 mm <sup>2</sup> ; 6-pole; 4,00 mm <sup>2</sup> ; green-yellow, blue, gray	<a href="http://www.wago.com/769-106/000-039">www.wago.com/769-106/000-039</a>
	<b>Item no.: 769-121</b> 2-conductor female connector; 4 mm <sup>2</sup> ; 1-pole; 4,00 mm <sup>2</sup> ; gray	<a href="http://www.wago.com/769-121">www.wago.com/769-121</a>
	<b>Item no.: 769-122</b> 2-conductor female connector; 4 mm <sup>2</sup> ; 2-pole; 4,00 mm <sup>2</sup> ; gray	<a href="http://www.wago.com/769-122">www.wago.com/769-122</a>
	<b>Item no.: 769-123</b> 2-conductor female connector; 4 mm <sup>2</sup> ; 3-pole; 4,00 mm <sup>2</sup> ; gray	<a href="http://www.wago.com/769-123">www.wago.com/769-123</a>
	<b>Item no.: 769-124</b> 2-conductor female connector; 4 mm <sup>2</sup> ; 4-pole; 4,00 mm <sup>2</sup> ; gray	<a href="http://www.wago.com/769-124">www.wago.com/769-124</a>
	<b>Item no.: 769-125</b> 2-conductor female connector; 4 mm <sup>2</sup> ; 5-pole; 4,00 mm <sup>2</sup> ; gray	<a href="http://www.wago.com/769-125">www.wago.com/769-125</a>

Subject to changes. Please also observe the further product documentation!



## Downloads

### Documentation

#### Additional Information

Technical explanations	Apr 3, 2019	pdf 2.1 MB	Download
------------------------	-------------	---------------	----------

## CAD/CAE-Data

### CAE data

WSCAD Universe 769-636/003-036	URL	Download
--------------------------------	-----	----------

### PCB Design

Symbol and Footprint 769-636/003-036	URL	Download
--------------------------------------	-----	----------

CAX data for your PCB design, consisting of "schematic symbols and PCB footprints", allow easy integration of the WAGO component into your development environment.

#### Supported formats:

- Accel EDA 14 & 15
- Altium 6 to current version
- Cadence Allegro
- DesignSpark
- Eagle Libraries
- KiCad
- Mentor Graphics BoardStation
- Mentor Graphics Design Architect
- Mentor Graphics Design Expedition 99 and 2000
- OrCAD 9.X PCB and Capture
- PADS PowerPCB 3, 3.5, 4.X, and 5.X
- PADS PowerPCB and PowerLogic 3.0
- PCAD 2000, 2001, 2002, 2004, and 2006
- Pulsonix 8.5 or newer
- STL
- 3D STEP
- TARGET 3001!
- View Logic ViewDraw
- Quadcept

Subject to changes. Please also observe the further product documentation!

- Zuken CadStar 3 and 4
- Zuken CR-5000 and CR-8000

PCB Component Libraries (EDA), PCB CAD Library Ultra Librarian

---

## Installation Notes

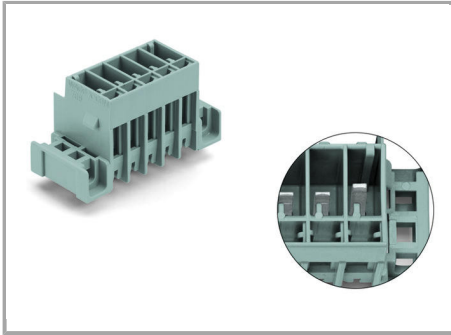

## Application

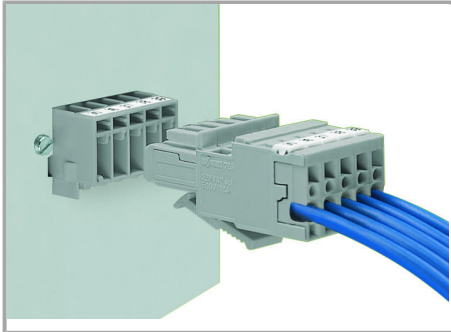

Male header with mounting flanges

1-conductor female plug with bottom-mount locking levers

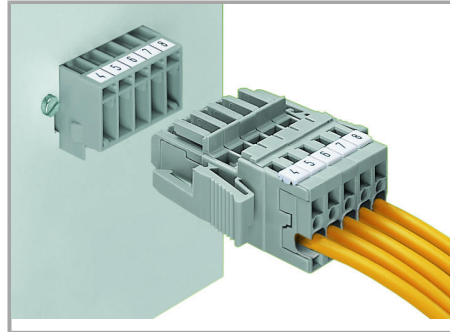

Male header with mounting flanges

1-conductor female plug with lateral locking levers

## Product family

### X-COM

[Learn more about the product family.](#)

[Show all products from the family](#)

Subject to changes. Please also observe the further product documentation!