

Data sheet | Item number: 769-608/006-000

1-conductor male connector; Snap-in flange; 4 mm²; Pin spacing 5 mm; 8-pole; 4,00 mm²; gray

www.wago.com/769-608/006-000

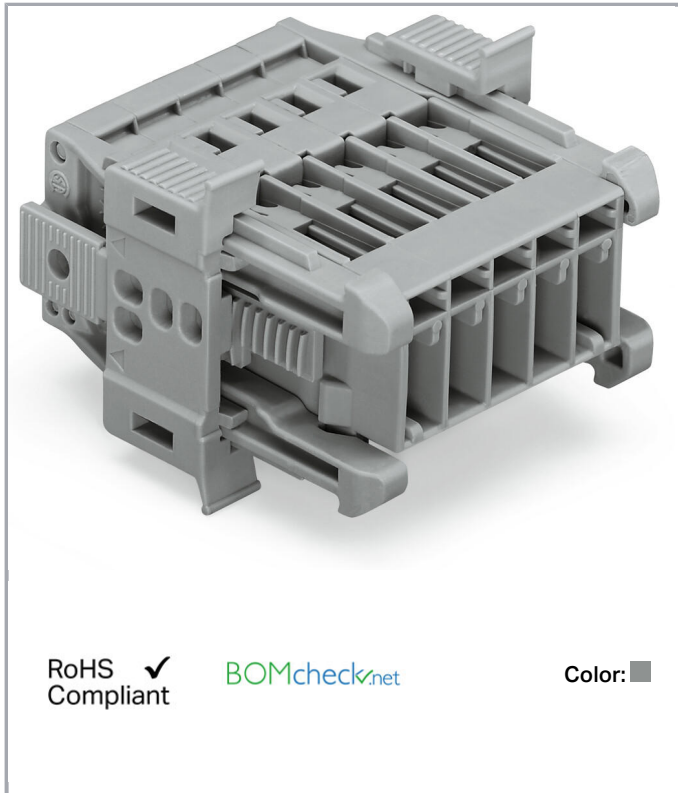

RoHS Compliant

BOMcheck.net

Color: ■

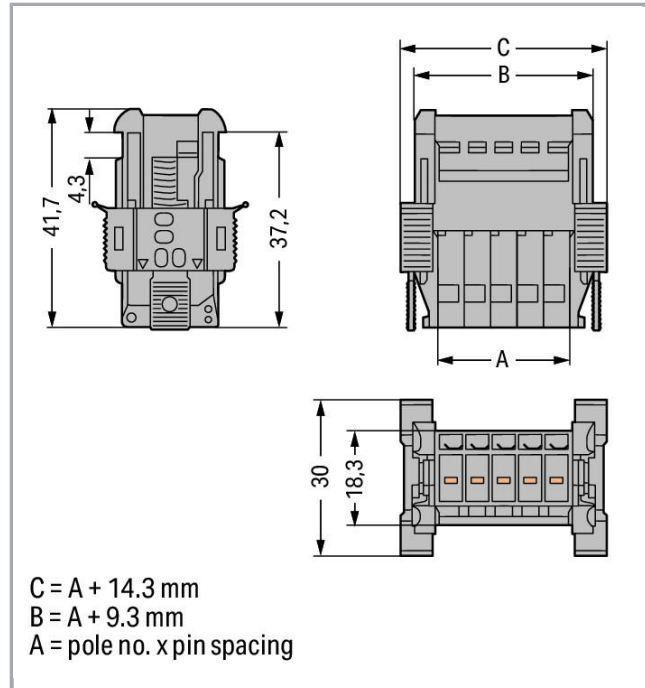

Data

Electrical data

Ratings per IEC/EN 60664-1

Rated voltage (III / 3)	500 V
Rated impulse voltage (III / 3)	6 kV
Rated current	32 A
Legend (ratings)	(III / 3) ≙ Overvoltage category III / Pollution degree 3

Connection data

Connection technology	CAGE CLAMP®
Actuation type	Operating tool
Connectable conductor materials	Copper

Subject to changes. Please also observe the further product documentation!

WAGO Kontakttechnik GmbH & Co. KG
Hansastr. 27
32423 Minden
Phone: +49571 887-0 | Fax: +49571 887-169
Email: info.de@wago.com | Web: www.wago.com

Do you have any questions about our products?
We are always happy to take your call at +49 (571) 887-44222.



Nominal cross section	4 mm ²
Solid conductor	0,08 ... 4 mm ² / 28 ... 12 AWG
Fine-stranded conductor	0,08 ... 4 mm ² / 28 ... 12 AWG
Strip length	8 ... 9 mm / 0.31 ... 0.35 inch
No. of poles	8
Total number of connection points	8
Total number of potentials	8
Type of wiring	Side-entry wiring

Geometrical Data

Pin spacing	5 mm / 0.197 inch
Width	54,3 mm / 2.138 inch
Height	30 mm / 1.181 inch
Depth	41,7 mm / 1.642 inch

Mechanical data

Mounting type	Snap-in
---------------	---------

Plug connection

Contact type (pluggable connector)	Male connector/plug
Connector connection type	for conductor

Material Data

Color	gray
Insulating material	Polyamide 66 (PA 66)
Fire load	0.61 MJ
Weight	28.3 g

Commercial data

Product Group	18 (X-COM-System)
Packaging type	BOX
Country of origin	PL
GTIN	4045454917050
Customs Tariff No.	85366990990



Subject to changes. Please also observe the further product documentation!

WAGO Kontakttechnik GmbH & Co. KG
 Hansastr. 27
 32423 Minden
 Phone: +49571 887-0 | Fax: +49571 887-169
 Email: info.de@wago.com | Web: www.wago.com



Do you have any questions about our products?
 We are always happy to take your call at +49 (571) 887-44222.

Approvals / Certificates

Country specific Approvals

Logo	Approval	Additional Approval Text	Certificate name
	CCA DEKRA Certification B.V.	EN 61984	2190419.02
	CCA DEKRA Certification B.V.	IEC 61984	NL-47799 /A1
	CSA DEKRA Certification B.V.	C22.2 No. 158	1101144

UL-Approvals

Logo	Approval	Additional Approval Text	Certificate name
	UR Underwriters Laboratories Inc.	UL 1977	20151210- E45171
	UR Underwriters Laboratories Inc.	UL 1059	20190731- E45172

Counterpart



Item no.769-108

1-conductor female plug; 4 mm²; 8-pole; 4,00 mm²; gray

www.wago.com/769-108



Item no.769-108/021-000

1-conductor female plug; Locking lever; 4 mm²; 8-pole; 4,00 mm²; gray

www.wago.com/769-108/021-000

Subject to changes. Please also observe the further product documentation!

WAGO Kontakttechnik GmbH & Co. KG

Hansastr. 27

32423 Minden

Phone: +49571 887-0 | Fax: +49571 887-169

Email: info.de@wago.com | Web: www.wago.com









Do you have any questions about our products?

We are always happy to take your call at +49 (571) 887-44222.

**Item no.769-128**2-conductor female connector; 4 mm²; 8-pole; 4,00 mm²; graywww.wago.com/769-128













Compatible products

ferrule

	Item no.: 216-101 Ferrule; Sleeve for 0.5 mm ² / AWG 22; uninsulated; electro-tin plated	www.wago.com/216-101
	Item no.: 216-102 Ferrule; Sleeve for 0.75 mm ² / AWG 20; uninsulated; electro-tin plated	www.wago.com/216-102
	Item no.: 216-103 Ferrule; Sleeve for 1 mm ² / AWG 18; uninsulated; electro-tin plated	www.wago.com/216-103
	Item no.: 216-104 Ferrule; Sleeve for 1.5 mm ² / AWG 16; uninsulated; electro-tin plated	www.wago.com/216-104
	Item no.: 216-201 Ferrule; Sleeve for 0.5 mm ² / 20 AWG; insulated; electro-tin plated; white	www.wago.com/216-201
	Item no.: 216-202 Ferrule; Sleeve for 0.75 mm ² / 18 AWG; insulated; electro-tin plated; gray	www.wago.com/216-202
	Item no.: 216-203 Ferrule; Sleeve for 1 mm ² / AWG 18; insulated; electro-tin plated; red	www.wago.com/216-203
	Item no.: 216-204 Ferrule; Sleeve for 1.5 mm ² / AWG 16; insulated; electro-tin plated; black	www.wago.com/216-204
	Item no.: 216-206 Ferrule; Sleeve for 2.5 mm ² / AWG 14; insulated; electro-tin plated; blue	www.wago.com/216-206
tools		
	Item no.: 210-490 Operating tool	www.wago.com/210-490
	Item no.: 769-434 Push-button; loose	www.wago.com/769-434

Subject to changes. Please also observe the further product documentation!

Female plug

	Item no.: 769-101 1-conductor female plug; 4 mm ² ; 1-pole; 4,00 mm ² ; gray	www.wago.com/769-101
	Item no.: 769-101/000-016 1-conductor female plug; 4 mm ² ; 1-pole; 4,00 mm ² ; green-yellow	www.wago.com/769-101/000-016
	Item no.: 769-102 1-conductor female plug; 4 mm ² ; 2-pole; 4,00 mm ² ; gray	www.wago.com/769-102
	Item no.: 769-102/000-036 1-conductor female plug; 4 mm ² ; 2-pole; 4,00 mm ² ; gray, green-yellow	www.wago.com/769-102/000-036
	Item no.: 769-102/000-037 1-conductor female plug; 4 mm ² ; 2-pole; 4,00 mm ² ; green-yellow, gray	www.wago.com/769-102/000-037
	Item no.: 769-103 1-conductor female plug; 4 mm ² ; 3-pole; 4,00 mm ² ; gray	www.wago.com/769-103
	Item no.: 769-103/000-036 1-conductor female plug; 4 mm ² ; 3-pole; 4,00 mm ² ; gray, green-yellow	www.wago.com/769-103/000-036
	Item no.: 769-103/000-037 1-conductor female plug; 4 mm ² ; 3-pole; 4,00 mm ² ; green-yellow, gray	www.wago.com/769-103/000-037
	Item no.: 769-103/000-038 1-conductor female plug; 4 mm ² ; 3-pole; 4,00 mm ² ; gray, blue, green-yellow	www.wago.com/769-103/000-038
	Item no.: 769-103/000-039 1-conductor female plug; 4 mm ² ; 3-pole; 4,00 mm ² ; green-yellow, blue, gray	www.wago.com/769-103/000-039
	Item no.: 769-104 1-conductor female plug; 4 mm ² ; 4-pole; 4,00 mm ² ; gray	www.wago.com/769-104
	Item no.: 769-104/000-036 1-conductor female plug; 4 mm ² ; 4-pole; 4,00 mm ² ; gray, green-yellow	www.wago.com/769-104/000-036
	Item no.: 769-104/000-037 1-conductor female plug; 4 mm ² ; 4-pole; 4,00 mm ² ; green-yellow, gray	www.wago.com/769-104/000-037
	Item no.: 769-104/000-038 1-conductor female plug; 4 mm ² ; 4-pole; 4,00 mm ² ; gray, blue, green-yellow	www.wago.com/769-104/000-038

Subject to changes. Please also observe the further product documentation!



Item no.: 769-104/000-039

1-conductor female plug; 4 mm²; 4-pole; 4,00 mm²; green-yellow, blue, gray

www.wago.com/769-104/000-039



Item no.: 769-105

1-conductor female plug; 4 mm²; 5-pole; 4,00 mm²; gray

www.wago.com/769-105



Item no.: 769-105/000-036

1-conductor female plug; 4 mm²; 5-pole; 4,00 mm²; gray, green-yellow

www.wago.com/769-105/000-036



Item no.: 769-105/000-037

1-conductor female plug; 4 mm²; 5-pole; 4,00 mm²; green-yellow, gray

www.wago.com/769-105/000-037



Item no.: 769-105/000-038

1-conductor female plug; 4 mm²; 5-pole; 4,00 mm²; gray, blue, green-yellow

www.wago.com/769-105/000-038

Item no.: 769-105/000-039

1-conductor female plug; 4 mm²; 5-pole; 4,00 mm²; green-yellow, blue, gray

www.wago.com/769-105/000-039



Item no.: 769-106

1-conductor female plug; 4 mm²; 6-pole; 4,00 mm²; gray

www.wago.com/769-106



Item no.: 769-106/000-006

1-conductor female plug; 4 mm²; 6-pole; 4,00 mm²; blue

www.wago.com/769-106/000-006



Item no.: 769-106/000-036

1-conductor female plug; 4 mm²; 6-pole; 4,00 mm²; gray, green-yellow

www.wago.com/769-106/000-036

Item no.: 769-106/000-037

1-conductor female plug; 4 mm²; 6-pole; 4,00 mm²; green-yellow, gray

www.wago.com/769-106/000-037



Item no.: 769-106/000-038

1-conductor female plug; 4 mm²; 6-pole; 4,00 mm²; gray, blue, green-yellow

www.wago.com/769-106/000-038



Item no.: 769-106/000-039

1-conductor female plug; 4 mm²; 6-pole; 4,00 mm²; green-yellow, blue, gray

www.wago.com/769-106/000-039

Item no.: 769-107

1-conductor female plug; 4 mm²; 7-pole; 4,00 mm²; gray

www.wago.com/769-107

Item no.: 769-107/000-036

1-conductor female plug; 4 mm²; 7-pole; 4,00 mm²; gray, green-yellow

www.wago.com/769-107/000-036

Subject to changes. Please also observe the further product documentation!

WAGO Kontakttechnik GmbH & Co. KG

Hansastr. 27

32423 Minden

Phone: +49571 887-0 | Fax: +49571 887-169

Email: info.de@wago.com | Web: www.wago.com

Do you have any questions about our products?

We are always happy to take your call at +49 (571) 887-44222.



Item no.: 769-107/000-037

1-conductor female plug; 4 mm²; 7-pole; 4,00 mm²; green-yellow, gray

www.wago.com/769-107/000-037



Item no.: 769-107/000-038

1-conductor female plug; 4 mm²; 7-pole; 4,00 mm²; gray, blue, green-yellow

www.wago.com/769-107/000-038



Item no.: 769-107/000-039

1-conductor female plug; 4 mm²; 7-pole; 4,00 mm²; green-yellow, blue, gray

www.wago.com/769-107/000-039



Item no.: 769-108/000-036

1-conductor female plug; 4 mm²; 8-pole; 4,00 mm²; gray, green-yellow

www.wago.com/769-108/000-036

Item no.: 769-108/000-037

1-conductor female plug; 4 mm²; 8-pole; 4,00 mm²; green-yellow, gray

www.wago.com/769-108/000-037



Item no.: 769-108/000-038

1-conductor female plug; 4 mm²; 8-pole; 4,00 mm²; gray, blue, green-yellow

www.wago.com/769-108/000-038



Item no.: 769-108/000-039

1-conductor female plug; 4 mm²; 8-pole; 4,00 mm²; green-yellow, blue, gray

www.wago.com/769-108/000-039



Item no.: 769-121

2-conductor female connector; 4 mm²; 1-pole; 4,00 mm²; gray

www.wago.com/769-121



Item no.: 769-121/000-016

2-conductor female connector; 4 mm²; 1-pole; 4,00 mm²; green-yellow

www.wago.com/769-121/000-016



Item no.: 769-122

2-conductor female connector; 4 mm²; 2-pole; 4,00 mm²; gray

www.wago.com/769-122



Item no.: 769-123

2-conductor female connector; 4 mm²; 3-pole; 4,00 mm²; gray

www.wago.com/769-123



Item no.: 769-124

2-conductor female connector; 4 mm²; 4-pole; 4,00 mm²; gray

www.wago.com/769-124

Item no.: 769-125

2-conductor female connector; 4 mm²; 5-pole; 4,00 mm²; gray

www.wago.com/769-125



Item no.: 769-126

2-conductor female connector; 4 mm²; 6-pole; 4,00 mm²; gray

www.wago.com/769-126















Item no.: 769-127

2-conductor female connector; 4 mm²; 7-pole; 4,00 mm²; gray

www.wago.com/769-127

Marking accessories

Subject to changes. Please also observe the further product documentation!

	Item no.: 2009-145 Mini-WSB Inline; for Smart Printer; 1700 pieces on roll; stretchable 5 - 5.2 mm; plain; snap-on type; white	www.wago.com/2009-145
	Item no.: 2009-145/000-002 Mini-WSB Inline; for Smart Printer; 1700 pieces on roll; stretchable 5 - 5.2 mm; plain; snap-on type; white /000-002	www.wago.com/2009-145/000-002
	Item no.: 2009-145/000-005 Mini-WSB Inline; for Smart Printer; 1700 pieces on roll; stretchable 5 - 5.2 mm; plain; snap-on type; red /000-005	www.wago.com/2009-145/000-005
	Item no.: 2009-145/000-006 Mini-WSB Inline; for Smart Printer; 1700 pieces on roll; stretchable 5 - 5.2 mm; plain; snap-on type; blue /000-006	www.wago.com/2009-145/000-006
	Item no.: 2009-145/000-007 Mini-WSB Inline; for Smart Printer; 1700 pieces on roll; stretchable 5 - 5.2 mm; plain; snap-on type; white /000-007	www.wago.com/2009-145/000-007
	Item no.: 2009-145/000-012 Mini-WSB Inline; for Smart Printer; 1700 pieces on roll; stretchable 5 - 5.2 mm; plain; snap-on type; orange /000-012	www.wago.com/2009-145/000-012
	Item no.: 2009-145/000-023 Mini-WSB Inline; for Smart Printer; 1700 pieces on roll; stretchable 5 - 5.2 mm; plain; snap-on type; green /000-023	www.wago.com/2009-145/000-023
	Item no.: 2009-145/000-024 Mini-WSB Inline; for Smart Printer; 1700 pieces on roll; stretchable 5 - 5.2 mm; plain; snap-on type; violet /000-024	www.wago.com/2009-145/000-024
	Item no.: 210-831 Marking strips; on reel; 2.3 mm wide; plain; Self-adhesive; white	www.wago.com/210-831
	Item no.: 210-832 Marking strips; on reel; 3 mm wide; plain; Self-adhesive; white	www.wago.com/210-832
	Item no.: 210-833 Marking strips; on reel; 6 mm wide; plain; Self-adhesive; white	www.wago.com/210-833
	Item no.: 210-834 Marking strips; on reel; 5 mm wide; plain; Self-adhesive; white	www.wago.com/210-834
	Item no.: 248-501 Miniature WSB Quick marking system; plain; Marker width 5 mm; 10 strips with 10 markers per card	www.wago.com/248-501
	Item no.: 248-501/000-002 Mini-WSB marking card; as card; not stretchable; plain; snap-on type; yellow /000-002	www.wago.com/248-501/000-002
	Item no.: 248-501/000-005 Mini-WSB marking card; as card; not stretchable; plain; snap-on type; red /000-005	www.wago.com/248-501/000-005

Subject to changes. Please also observe the further product documentation!



Item no.: 248-501/000-006
Mini-WSB marking card; as card; not stretchable; plain; snap-on type; blue

www.wago.com/248-501/000-006



Item no.: 248-501/000-007
Mini-WSB marking card; as card; not stretchable; plain; snap-on type; gray

www.wago.com/248-501/000-007



Item no.: 248-501/000-012
Mini-WSB marking card; as card; not stretchable; plain; snap-on type; orange

www.wago.com/248-501/000-012



Item no.: 248-501/000-017
Mini-WSB marking card; as card; not stretchable; plain; snap-on type; light green

www.wago.com/248-501/000-017



Item no.: 248-501/000-023
Mini-WSB marking card; as card; not stretchable; plain; snap-on type; green

www.wago.com/248-501/000-023



Item no.: 248-501/000-024
Mini-WSB marking card; as card; not stretchable; plain; snap-on type; violet

www.wago.com/248-501/000-024

Strain relief plate



Item no.: 769-410
Strain relief plate; gray

www.wago.com/769-410



Item no.: 769-413
Strain relief plate; gray

www.wago.com/769-413

Insulation stop



Item no.: 769-470
Insulation stop; 0.08 - 0.2 mm² "s" (0.14 mm² "f-st"); 5 pieces/strip; white

www.wago.com/769-470



Item no.: 769-471
Insulation stop; 0.25 - 0.5 mm²; 5 pieces/strip; light gray

www.wago.com/769-471



Item no.: 769-472
Insulation stop; 0.75 - 1 mm²; 5 pieces/strip; dark gray

www.wago.com/769-472

Coding

Item no.: 769-435
Coding pin; for coding of female plugs; for carrier terminal blocks / male connectors; orange

www.wago.com/769-435

Protective Warning Marker



Item no.: 280-415
Protective warning marker; with high-voltage symbol, black; for 5 terminal blocks; yellow

www.wago.com/280-415

Downloads

Documentation

Subject to changes. Please also observe the further product documentation!

Additional Information

Technical explanations

Apr 3, 2019

pdf
2.1 MB

[Download](#)

CAD/CAE-Data

CAD data

2D/3D Models 769-608/006-000

[URL](#)

[Download](#)

CAE data

EPLAN Data Portal 769-608/006-000

[URL](#)

[Download](#)

WSCAD Universe 769-608/006-000

[URL](#)

[Download](#)

Installation Notes

Assembly

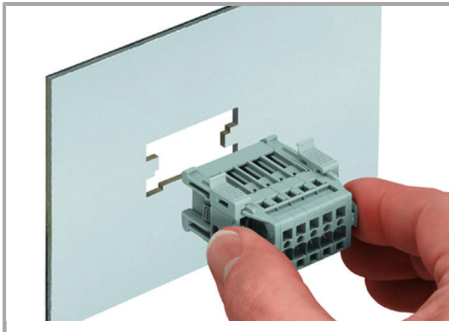

Insert male connector with snap-in flanges (769-605/006-000) into the cutout.

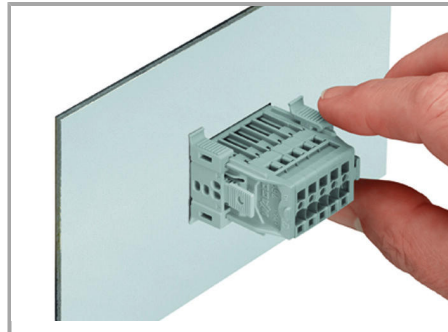

Secure the snap-in flange.

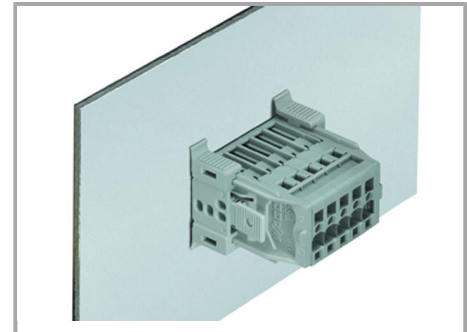

Male connector with snap-in flanges (769-605/006-000) into the cutout

Subject to changes. Please also observe the further product documentation!

WAGO Kontakttechnik GmbH & Co. KG

Hansastr. 27

32423 Minden

Phone: +49571 887-0 | Fax: +49571 887-169

Email: info.de@wago.com | Web: www.wago.com

Do you have any questions about our products?

We are always happy to take your call at +49 (571) 887-44222.

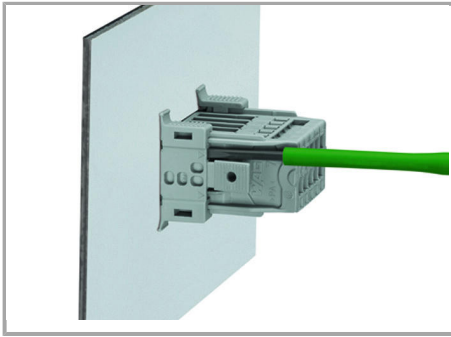

For removal, insert operating tool (2.5 mm blade) into release slot.

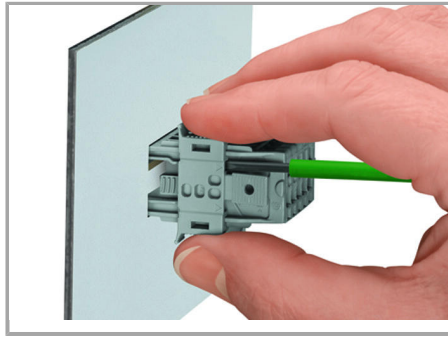

Press center part on both the top and bottom of the connector. Then remove snap-in flange.

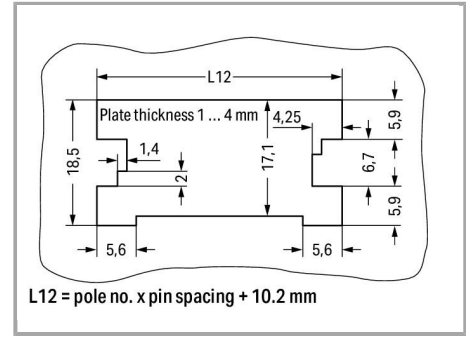

Sheet metal cutout (for female plugs without locking levers)

Male connectors with CAGE CLAMP® connection (769-6xx/006-000) and snap-in flanges

Inserting a conductor

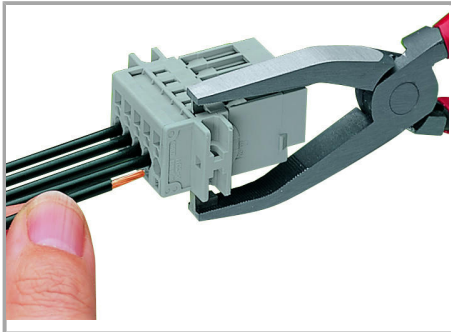

Operating tool

Inserting a conductor via operating tool (example shows a male connector).

Marking

Subject to changes. Please also observe the further product documentation!

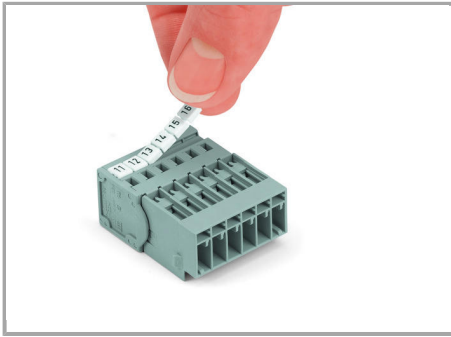

Labeling a male connector with
CAGE CLAMP® connection via Mini-WSB
quick markers.

Product family

X-COM

[Learn more about the product family.](#)

[Show all products from the family](#)

Subject to changes. Please also observe the further product documentation!