

## Data sheet | Item number: 769-608/005-000

1-conductor male connector; Snap-in flange; 4 mm<sup>2</sup>; Pin spacing 5 mm; 8-pole; 4,00 mm<sup>2</sup>; gray

[www.wago.com/769-608/005-000](http://www.wago.com/769-608/005-000)

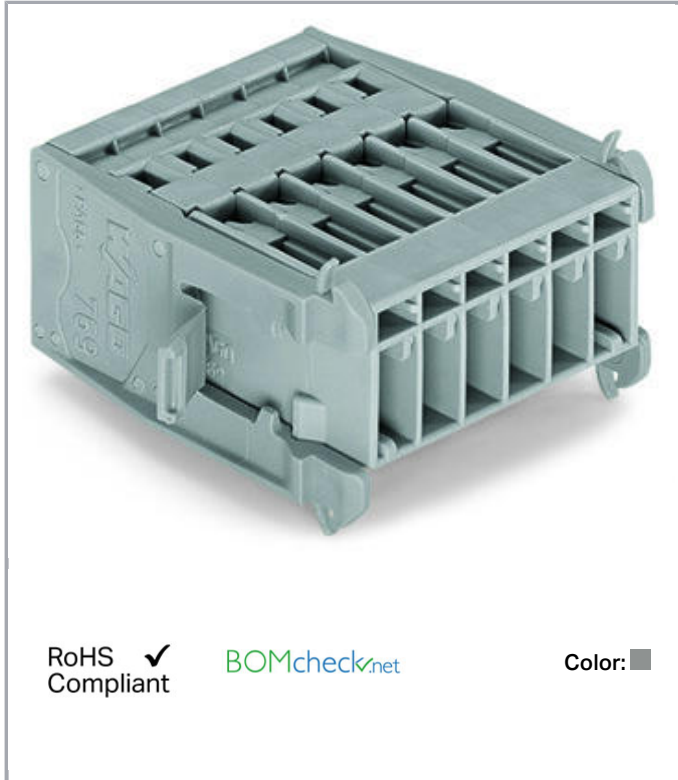

RoHS  Compliant

BOMcheck.net

Color: ■

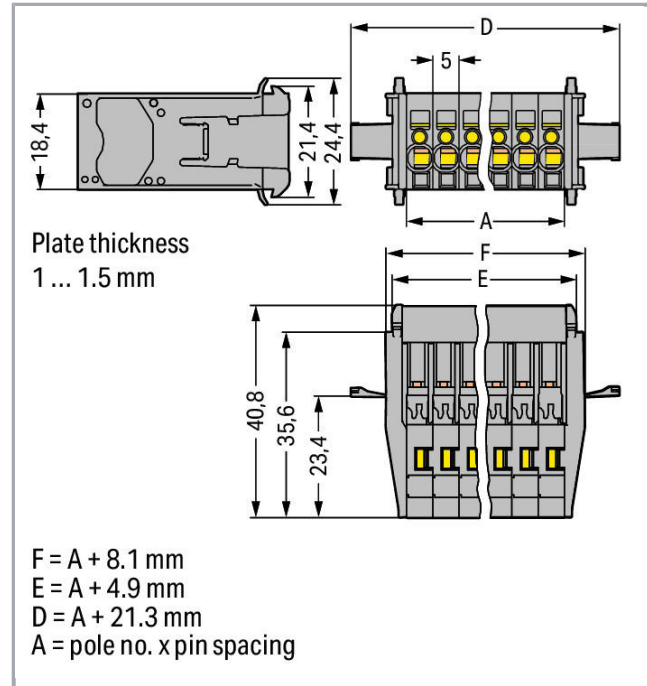

### Data

#### Electrical data

#### Ratings per IEC/EN 60664-1

Rated voltage (III / 3)	500 V
Rated impulse voltage (III / 3)	6 kV
Rated current	32 A
Legend (ratings)	(III / 3) ≙ Overvoltage category III / Pollution degree 3

#### Connection data

Connection technology	CAGE CLAMP®
Actuation type	Operating tool
Connectable conductor materials	Copper

Subject to changes. Please also observe the further product documentation!

WAGO Kontakttechnik GmbH & Co. KG  
Hansastr. 27  
32423 Minden  
Phone: +49571 887-0 | Fax: +49571 887-169  
Email: [info.de@wago.com](mailto:info.de@wago.com) | Web: [www.wago.com](http://www.wago.com)

Do you have any questions about our products?  
We are always happy to take your call at +49 (571) 887-44222.



Nominal cross section	4 mm <sup>2</sup>
Solid conductor	0,08 ... 4 mm <sup>2</sup> / 28 ... 12 AWG
Fine-stranded conductor	0,08 ... 4 mm <sup>2</sup> / 28 ... 12 AWG
Strip length	8 ... 9 mm / 0.31 ... 0.35 inch
No. of poles	8
Total number of connection points	8
Total number of potentials	8
Type of wiring	Front-entry wiring

### Geometrical Data

Pin spacing	5 mm / 0.197 inch
Width	61,3 mm / 2.413 inch
Height	24,4 mm / 0.961 inch
Depth	40,8 mm / 1.606 inch

### Mechanical data

Mounting type	Snap-in
---------------	---------

### Plug connection

Contact type (pluggable connector)	Male connector/plug
Connector connection type	for conductor

### Material Data

Color	gray
Insulating material	Polyamide 66 (PA 66)
Fire load	0.52 MJ
Weight	25.4 g

### Commercial data

Product Group	18 (X-COM-System)
Packaging type	BOX
Country of origin	PL
GTIN	4044918840958
Customs Tariff No.	85366990990



Subject to changes. Please also observe the further product documentation!

WAGO Kontakttechnik GmbH & Co. KG  
 Hansastr. 27  
 32423 Minden  
 Phone: +49571 887-0 | Fax: +49571 887-169  
 Email: [info.de@wago.com](mailto:info.de@wago.com) | Web: [www.wago.com](http://www.wago.com)



Do you have any questions about our products?  
 We are always happy to take your call at +49 (571) 887-44222.

## Approvals / Certificates

### Country specific Approvals

Logo	Approval	Additional Approval Text	Certificate name
	CCA DEKRA Certification B.V.	EN 61984	2190419.02
	CCA DEKRA Certification B.V.	IEC 61984	NL-47799 /A1
	CSA DEKRA Certification B.V.	C22.2 No. 158	1101144

### UL-Approvals

Logo	Approval	Additional Approval Text	Certificate name
	UR Underwriters Laboratories Inc.	UL 1059	20190731- E45172
	UR Underwriters Laboratories Inc.	UL 1977	20151210- E45171

## Counterpart



### Item no.769-108

1-conductor female plug; 4 mm<sup>2</sup>; 8-pole; 4,00 mm<sup>2</sup>; gray

[www.wago.com/769-108](http://www.wago.com/769-108)



### Item no.769-108/021-000

1-conductor female plug; Locking lever; 4 mm<sup>2</sup>; 8-pole; 4,00 mm<sup>2</sup>; gray

[www.wago.com/769-108/021-000](http://www.wago.com/769-108/021-000)

Subject to changes. Please also observe the further product documentation!

WAGO Kontakttechnik GmbH & Co. KG

Hansastr. 27

32423 Minden

Phone: +49571 887-0 | Fax: +49571 887-169

Email: [info.de@wago.com](mailto:info.de@wago.com) | Web: [www.wago.com](http://www.wago.com)

Do you have any questions about our products?

We are always happy to take your call at +49 (571) 887-44222.



Item no. 769-128

2-conductor female connector; 4 mm<sup>2</sup>; 8-pole; 4,00 mm<sup>2</sup>; gray

[www.wago.com/769-128](http://www.wago.com/769-128)

## Compatible products

### Coding



Item no.: 769-435

Coding pin; for coding of female plugs; for carrier terminal blocks / male connectors; orange

[www.wago.com/769-435](http://www.wago.com/769-435)

### Protective Warning Marker

Item no.: 280-415

Protective warning marker; with high-voltage symbol, black; for 5 terminal blocks; yellow

[www.wago.com/280-415](http://www.wago.com/280-415)

### Female plug

Item no.: 769-101

1-conductor female plug; 4 mm<sup>2</sup>; 1-pole; 4,00 mm<sup>2</sup>; gray

[www.wago.com/769-101](http://www.wago.com/769-101)

Item no.: 769-101/000-016

1-conductor female plug; 4 mm<sup>2</sup>; 1-pole; 4,00 mm<sup>2</sup>; green-yellow

[www.wago.com/769-101/000-016](http://www.wago.com/769-101/000-016)

Item no.: 769-102

1-conductor female plug; 4 mm<sup>2</sup>; 2-pole; 4,00 mm<sup>2</sup>; gray

[www.wago.com/769-102](http://www.wago.com/769-102)

Item no.: 769-102/000-036

1-conductor female plug; 4 mm<sup>2</sup>; 2-pole; 4,00 mm<sup>2</sup>; gray, green-yellow

[www.wago.com/769-102/000-036](http://www.wago.com/769-102/000-036)

Item no.: 769-102/000-037

1-conductor female plug; 4 mm<sup>2</sup>; 2-pole; 4,00 mm<sup>2</sup>; green-yellow, gray

[www.wago.com/769-102/000-037](http://www.wago.com/769-102/000-037)

Item no.: 769-103

1-conductor female plug; 4 mm<sup>2</sup>; 3-pole; 4,00 mm<sup>2</sup>; gray

[www.wago.com/769-103](http://www.wago.com/769-103)

Item no.: 769-103/000-036

1-conductor female plug; 4 mm<sup>2</sup>; 3-pole; 4,00 mm<sup>2</sup>; gray, green-yellow

[www.wago.com/769-103/000-036](http://www.wago.com/769-103/000-036)

Subject to changes. Please also observe the further product documentation!

WAGO Kontakttechnik GmbH & Co. KG

Hansastr. 27

32423 Minden

Phone: +49571 887-0 | Fax: +49571 887-169

Email: [info.de@wago.com](mailto:info.de@wago.com) | Web: [www.wago.com](http://www.wago.com)

Do you have any questions about our products?

We are always happy to take your call at +49 (571) 887-44222.

**Item no.: 769-103/000-037**

1-conductor female plug; 4 mm<sup>2</sup>; 3-pole; 4,00 mm<sup>2</sup>; green-yellow, gray

[www.wago.com/769-103/000-037](http://www.wago.com/769-103/000-037)

**Item no.: 769-103/000-038**

1-conductor female plug; 4 mm<sup>2</sup>; 3-pole; 4,00 mm<sup>2</sup>; gray, blue, green-yellow

[www.wago.com/769-103/000-038](http://www.wago.com/769-103/000-038)

**Item no.: 769-103/000-039**

1-conductor female plug; 4 mm<sup>2</sup>; 3-pole; 4,00 mm<sup>2</sup>; green-yellow, blue, gray

[www.wago.com/769-103/000-039](http://www.wago.com/769-103/000-039)



**Item no.: 769-104**

1-conductor female plug; 4 mm<sup>2</sup>; 4-pole; 4,00 mm<sup>2</sup>; gray

[www.wago.com/769-104](http://www.wago.com/769-104)

**Item no.: 769-104/000-036**

1-conductor female plug; 4 mm<sup>2</sup>; 4-pole; 4,00 mm<sup>2</sup>; gray, green-yellow

[www.wago.com/769-104/000-036](http://www.wago.com/769-104/000-036)

**Item no.: 769-104/000-037**

1-conductor female plug; 4 mm<sup>2</sup>; 4-pole; 4,00 mm<sup>2</sup>; green-yellow, gray

[www.wago.com/769-104/000-037](http://www.wago.com/769-104/000-037)

**Item no.: 769-104/000-038**

1-conductor female plug; 4 mm<sup>2</sup>; 4-pole; 4,00 mm<sup>2</sup>; gray, blue, green-yellow

[www.wago.com/769-104/000-038](http://www.wago.com/769-104/000-038)

**Item no.: 769-104/000-039**

1-conductor female plug; 4 mm<sup>2</sup>; 4-pole; 4,00 mm<sup>2</sup>; green-yellow, blue, gray

[www.wago.com/769-104/000-039](http://www.wago.com/769-104/000-039)

**Item no.: 769-105**

1-conductor female plug; 4 mm<sup>2</sup>; 5-pole; 4,00 mm<sup>2</sup>; gray

[www.wago.com/769-105](http://www.wago.com/769-105)

**Item no.: 769-105/000-036**

1-conductor female plug; 4 mm<sup>2</sup>; 5-pole; 4,00 mm<sup>2</sup>; gray, green-yellow

[www.wago.com/769-105/000-036](http://www.wago.com/769-105/000-036)

**Item no.: 769-105/000-037**

1-conductor female plug; 4 mm<sup>2</sup>; 5-pole; 4,00 mm<sup>2</sup>; green-yellow, gray

[www.wago.com/769-105/000-037](http://www.wago.com/769-105/000-037)

**Item no.: 769-105/000-038**

1-conductor female plug; 4 mm<sup>2</sup>; 5-pole; 4,00 mm<sup>2</sup>; gray, blue, green-yellow

[www.wago.com/769-105/000-038](http://www.wago.com/769-105/000-038)



**Item no.: 769-105/000-039**

1-conductor female plug; 4 mm<sup>2</sup>; 5-pole; 4,00 mm<sup>2</sup>; green-yellow, blue, gray

[www.wago.com/769-105/000-039](http://www.wago.com/769-105/000-039)

**Item no.: 769-106**

1-conductor female plug; 4 mm<sup>2</sup>; 6-pole; 4,00 mm<sup>2</sup>; gray

[www.wago.com/769-106](http://www.wago.com/769-106)

Subject to changes. Please also observe the further product documentation!

WAGO Kontakttechnik GmbH & Co. KG

Hansastr. 27

32423 Minden

Phone: +49571 887-0 | Fax: +49571 887-169

Email: [info.de@wago.com](mailto:info.de@wago.com) | Web: [www.wago.com](http://www.wago.com)

Do you have any questions about our products?

We are always happy to take your call at +49 (571) 887-44222.



**Item no.: 769-106/000-006**

1-conductor female plug; 4 mm<sup>2</sup>; 6-pole; 4,00 mm<sup>2</sup>; blue

[www.wago.com/769-106/000-006](http://www.wago.com/769-106/000-006)



**Item no.: 769-106/000-036**

1-conductor female plug; 4 mm<sup>2</sup>; 6-pole; 4,00 mm<sup>2</sup>; gray, green-yellow

[www.wago.com/769-106/000-036](http://www.wago.com/769-106/000-036)

**Item no.: 769-106/000-037**

1-conductor female plug; 4 mm<sup>2</sup>; 6-pole; 4,00 mm<sup>2</sup>; green-yellow, gray

[www.wago.com/769-106/000-037](http://www.wago.com/769-106/000-037)

**Item no.: 769-106/000-038**

1-conductor female plug; 4 mm<sup>2</sup>; 6-pole; 4,00 mm<sup>2</sup>; gray, blue, green-yellow

[www.wago.com/769-106/000-038](http://www.wago.com/769-106/000-038)

**Item no.: 769-106/000-039**

1-conductor female plug; 4 mm<sup>2</sup>; 6-pole; 4,00 mm<sup>2</sup>; green-yellow, blue, gray

[www.wago.com/769-106/000-039](http://www.wago.com/769-106/000-039)

**Item no.: 769-107**

1-conductor female plug; 4 mm<sup>2</sup>; 7-pole; 4,00 mm<sup>2</sup>; gray

[www.wago.com/769-107](http://www.wago.com/769-107)



**Item no.: 769-107/000-036**

1-conductor female plug; 4 mm<sup>2</sup>; 7-pole; 4,00 mm<sup>2</sup>; gray, green-yellow

[www.wago.com/769-107/000-036](http://www.wago.com/769-107/000-036)



**Item no.: 769-107/000-037**

1-conductor female plug; 4 mm<sup>2</sup>; 7-pole; 4,00 mm<sup>2</sup>; green-yellow, gray

[www.wago.com/769-107/000-037](http://www.wago.com/769-107/000-037)

**Item no.: 769-107/000-038**

1-conductor female plug; 4 mm<sup>2</sup>; 7-pole; 4,00 mm<sup>2</sup>; gray, blue, green-yellow

[www.wago.com/769-107/000-038](http://www.wago.com/769-107/000-038)



**Item no.: 769-107/000-039**

1-conductor female plug; 4 mm<sup>2</sup>; 7-pole; 4,00 mm<sup>2</sup>; green-yellow, blue, gray

[www.wago.com/769-107/000-039](http://www.wago.com/769-107/000-039)

**Item no.: 769-108/000-036**

1-conductor female plug; 4 mm<sup>2</sup>; 8-pole; 4,00 mm<sup>2</sup>; gray, green-yellow

[www.wago.com/769-108/000-036](http://www.wago.com/769-108/000-036)



**Item no.: 769-108/000-037**

1-conductor female plug; 4 mm<sup>2</sup>; 8-pole; 4,00 mm<sup>2</sup>; green-yellow, gray

[www.wago.com/769-108/000-037](http://www.wago.com/769-108/000-037)



**Item no.: 769-108/000-038**

1-conductor female plug; 4 mm<sup>2</sup>; 8-pole; 4,00 mm<sup>2</sup>; gray, blue, green-yellow

[www.wago.com/769-108/000-038](http://www.wago.com/769-108/000-038)

Subject to changes. Please also observe the further product documentation!

WAGO Kontakttechnik GmbH & Co. KG

Hansastr. 27

32423 Minden

Phone: +49571 887-0 | Fax: +49571 887-169

Email: [info.de@wago.com](mailto:info.de@wago.com) | Web: [www.wago.com](http://www.wago.com)

Do you have any questions about our products?

We are always happy to take your call at +49 (571) 887-44222.

**Item no.: 769-108/000-039**

1-conductor female plug; 4 mm<sup>2</sup>; 8-pole; 4,00 mm<sup>2</sup>; green-yellow, blue, gray

[www.wago.com/769-108/000-039](http://www.wago.com/769-108/000-039)



**Item no.: 769-121**

2-conductor female connector; 4 mm<sup>2</sup>; 1-pole; 4,00 mm<sup>2</sup>; gray

[www.wago.com/769-121](http://www.wago.com/769-121)



**Item no.: 769-121/000-016**

2-conductor female connector; 4 mm<sup>2</sup>; 1-pole; 4,00 mm<sup>2</sup>; green-yellow

[www.wago.com/769-121/000-016](http://www.wago.com/769-121/000-016)



**Item no.: 769-122**

2-conductor female connector; 4 mm<sup>2</sup>; 2-pole; 4,00 mm<sup>2</sup>; gray

[www.wago.com/769-122](http://www.wago.com/769-122)



**Item no.: 769-123**

2-conductor female connector; 4 mm<sup>2</sup>; 3-pole; 4,00 mm<sup>2</sup>; gray

[www.wago.com/769-123](http://www.wago.com/769-123)



**Item no.: 769-124**

2-conductor female connector; 4 mm<sup>2</sup>; 4-pole; 4,00 mm<sup>2</sup>; gray

[www.wago.com/769-124](http://www.wago.com/769-124)



**Item no.: 769-125**

2-conductor female connector; 4 mm<sup>2</sup>; 5-pole; 4,00 mm<sup>2</sup>; gray

[www.wago.com/769-125](http://www.wago.com/769-125)



**Item no.: 769-126**

2-conductor female connector; 4 mm<sup>2</sup>; 6-pole; 4,00 mm<sup>2</sup>; gray

[www.wago.com/769-126](http://www.wago.com/769-126)



**Item no.: 769-127**

2-conductor female connector; 4 mm<sup>2</sup>; 7-pole; 4,00 mm<sup>2</sup>; gray

[www.wago.com/769-127](http://www.wago.com/769-127)

**Marking accessories**

**Item no.: 2009-145**

Mini-WSB Inline; for Smart Printer; 1700 pieces on roll; stretchable 5 - 5.2 mm; plain; snap-on type; white

[www.wago.com/2009-145](http://www.wago.com/2009-145)

**Item no.: 2009-145/000-002**

Mini-WSB Inline; for Smart Printer; 1700 pieces on roll; stretchable 5 - 5.2 mm; plain; snap-on type; white /000-002

[www.wago.com/2009-145/000-002](http://www.wago.com/2009-145/000-002)

**Item no.: 2009-145/000-005**

Mini-WSB Inline; for Smart Printer; 1700 pieces on roll; stretchable 5 - 5.2 mm; plain; snap-on type; red

[www.wago.com/2009-145/000-005](http://www.wago.com/2009-145/000-005)

**Item no.: 2009-145/000-006**

Mini-WSB Inline; for Smart Printer; 1700 pieces on roll; stretchable 5 - 5.2 mm; plain; snap-on type; blue

[www.wago.com/2009-145/000-006](http://www.wago.com/2009-145/000-006)

**Item no.: 2009-145/000-007**

Mini-WSB Inline; for Smart Printer; 1700 pieces on roll; stretchable 5 - 5.2 mm; plain; snap-on type; white /000-007

[www.wago.com/2009-145/000-007](http://www.wago.com/2009-145/000-007)

**Item no.: 2009-145/000-012**

Mini-WSB Inline; for Smart Printer; 1700 pieces on roll; stretchable 5 - 5.2 mm; plain; snap-on type; orange

[www.wago.com/2009-145/000-012](http://www.wago.com/2009-145/000-012)

Subject to changes. Please also observe the further product documentation!

WAGO Kontakttechnik GmbH & Co. KG

Hansastr. 27





32423 Minden

Phone: +49571 887-0 | Fax: +49571 887-169

Email: [info.de@wago.com](mailto:info.de@wago.com) | Web: [www.wago.com](http://www.wago.com)

Do you have any questions about our products?

We are always happy to take your call at +49 (571) 887-44222.

	<p><b>Item no.: 2009-145/000-023</b> Mini-WSB Inline; for Smart Printer; 1700 pieces on roll; stretchable 5 - 5.2 mm; plain; snap-on type; green</p>	<p><a href="http://www.wago.com/2009-145/000-023">www.wago.com/2009-145/000-023</a></p>
	<p><b>Item no.: 2009-145/000-024</b> Mini-WSB Inline; for Smart Printer; 1700 pieces on roll; stretchable 5 - 5.2 mm; plain; snap-on type; violet</p>	<p><a href="http://www.wago.com/2009-145/000-024">www.wago.com/2009-145/000-024</a></p>
	<p><b>Item no.: 210-831</b> Marking strips; on reel; 2.3 mm wide; plain; Self-adhesive; white</p>	<p><a href="http://www.wago.com/210-831">www.wago.com/210-831</a></p>
	<p><b>Item no.: 210-832</b> Marking strips; on reel; 3 mm wide; plain; Self-adhesive; white</p>	<p><a href="http://www.wago.com/210-832">www.wago.com/210-832</a></p>
	<p><b>Item no.: 210-833</b> Marking strips; on reel; 6 mm wide; plain; Self-adhesive; white</p>	<p><a href="http://www.wago.com/210-833">www.wago.com/210-833</a></p>
	<p><b>Item no.: 210-834</b> Marking strips; on reel; 5 mm wide; plain; Self-adhesive; white</p>	<p><a href="http://www.wago.com/210-834">www.wago.com/210-834</a></p>
	<p><b>Item no.: 248-501</b> Miniature WSB Quick marking system; plain; Marker width 5 mm; 10 strips with 10 markers per card</p>	<p><a href="http://www.wago.com/248-501">www.wago.com/248-501</a></p>
	<p><b>Item no.: 248-501/000-002</b> Mini-WSB marking card; as card; not stretchable; plain; snap-on type; yellow</p>	<p><a href="http://www.wago.com/248-501/000-002">www.wago.com/248-501/000-002</a></p>
	<p><b>Item no.: 248-501/000-005</b> Mini-WSB marking card; as card; not stretchable; plain; snap-on type; red</p>	<p><a href="http://www.wago.com/248-501/000-005">www.wago.com/248-501/000-005</a></p>
	<p><b>Item no.: 248-501/000-006</b> Mini-WSB marking card; as card; not stretchable; plain; snap-on type; blue</p>	<p><a href="http://www.wago.com/248-501/000-006">www.wago.com/248-501/000-006</a></p>
	<p><b>Item no.: 248-501/000-007</b> Mini-WSB marking card; as card; not stretchable; plain; snap-on type; gray</p>	<p><a href="http://www.wago.com/248-501/000-007">www.wago.com/248-501/000-007</a></p>
	<p><b>Item no.: 248-501/000-012</b> Mini-WSB marking card; as card; not stretchable; plain; snap-on type; orange</p>	<p><a href="http://www.wago.com/248-501/000-012">www.wago.com/248-501/000-012</a></p>
	<p><b>Item no.: 248-501/000-017</b> Mini-WSB marking card; as card; not stretchable; plain; snap-on type; light green</p>	<p><a href="http://www.wago.com/248-501/000-017">www.wago.com/248-501/000-017</a></p>
	<p><b>Item no.: 248-501/000-023</b> Mini-WSB marking card; as card; not stretchable; plain; snap-on type; green</p>	<p><a href="http://www.wago.com/248-501/000-023">www.wago.com/248-501/000-023</a></p>
	<p><b>Item no.: 248-501/000-024</b> Mini-WSB marking card; as card; not stretchable; plain; snap-on type; violet</p>	<p><a href="http://www.wago.com/248-501/000-024">www.wago.com/248-501/000-024</a></p>

Subject to changes. Please also observe the further product documentation!



## ferrule

	<b>Item no.: 216-101</b> Ferrule; Sleeve for 0.5 mm <sup>2</sup> / AWG 22; uninsulated; electro-tin plated	<a href="http://www.wago.com/216-101">www.wago.com/216-101</a>
	<b>Item no.: 216-102</b> Ferrule; Sleeve for 0.75 mm <sup>2</sup> / AWG 20; uninsulated; electro-tin plated	<a href="http://www.wago.com/216-102">www.wago.com/216-102</a>
	<b>Item no.: 216-103</b> Ferrule; Sleeve for 1 mm <sup>2</sup> / AWG 18; uninsulated; electro-tin plated	<a href="http://www.wago.com/216-103">www.wago.com/216-103</a>
	<b>Item no.: 216-104</b> Ferrule; Sleeve for 1.5 mm <sup>2</sup> / AWG 16; uninsulated; electro-tin plated	<a href="http://www.wago.com/216-104">www.wago.com/216-104</a>
	<b>Item no.: 216-201</b> Ferrule; Sleeve for 0.5 mm <sup>2</sup> / 20 AWG; insulated; electro-tin plated; white	<a href="http://www.wago.com/216-201">www.wago.com/216-201</a>
	<b>Item no.: 216-202</b> Ferrule; Sleeve for 0.75 mm <sup>2</sup> / 18 AWG; insulated; electro-tin plated; gray	<a href="http://www.wago.com/216-202">www.wago.com/216-202</a>
	<b>Item no.: 216-203</b> Ferrule; Sleeve for 1 mm <sup>2</sup> / AWG 18; insulated; electro-tin plated; red	<a href="http://www.wago.com/216-203">www.wago.com/216-203</a>
	<b>Item no.: 216-204</b> Ferrule; Sleeve for 1.5 mm <sup>2</sup> / AWG 16; insulated; electro-tin plated; black	<a href="http://www.wago.com/216-204">www.wago.com/216-204</a>
	<b>Item no.: 216-206</b> Ferrule; Sleeve for 2.5 mm <sup>2</sup> / AWG 14; insulated; electro-tin plated; blue	<a href="http://www.wago.com/216-206">www.wago.com/216-206</a>

## Insulation stop

	<b>Item no.: 769-470</b> Insulation stop; 0.08 - 0.2 mm <sup>2</sup> "s" (0.14 mm <sup>2</sup> "f-st"); 5 pieces/strip; white	<a href="http://www.wago.com/769-470">www.wago.com/769-470</a>
	<b>Item no.: 769-471</b> Insulation stop; 0.25 - 0.5 mm <sup>2</sup> ; 5 pieces/strip; light gray	<a href="http://www.wago.com/769-471">www.wago.com/769-471</a>
	<b>Item no.: 769-472</b> Insulation stop; 0.75 - 1 mm <sup>2</sup> ; 5 pieces/strip; dark gray	<a href="http://www.wago.com/769-472">www.wago.com/769-472</a>

## Strain relief plate

	<b>Item no.: 769-410</b> Strain relief plate; gray	<a href="http://www.wago.com/769-410">www.wago.com/769-410</a>
	<b>Item no.: 769-413</b> Strain relief plate; gray	<a href="http://www.wago.com/769-413">www.wago.com/769-413</a>

## tools

	<b>Item no.: 210-490</b> Operating tool	<a href="http://www.wago.com/210-490">www.wago.com/210-490</a>
	<b>Item no.: 769-434</b> Push-button; loose	<a href="http://www.wago.com/769-434">www.wago.com/769-434</a>

Subject to changes. Please also observe the further product documentation!

## Downloads Documentation

### Additional Information

Technical explanations	Apr 3, 2019	pdf 2.1 MB	Download
------------------------	-------------	---------------	----------

## CAD/CAE-Data

### CAD data

2D/3D Models 769-608/005-000	URL	Download
------------------------------	-----	----------

### CAE data

EPLAN Data Portal 769-608/005-000	URL	Download
-----------------------------------	-----	----------

WSCAD Universe 769-608/005-000	URL	Download
--------------------------------	-----	----------

## Installation Notes

### Assembly

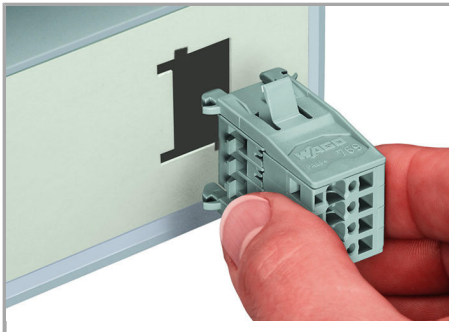

Insert male connector with snap-in flanges (769-604/005-000) into the cutout.



Male connector with snap-in flanges



Snap-in mounting without tools

Snap-in mounting without tools

Subject to changes. Please also observe the further product documentation!

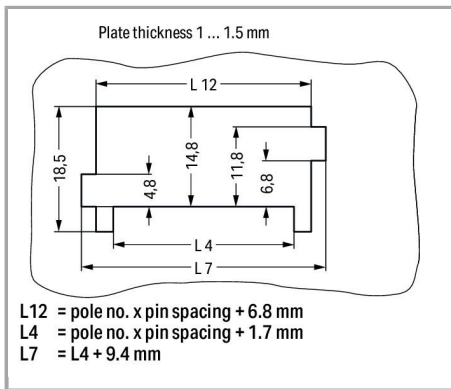

Sheet metal cutout

Male connectors with CAGE CLAMP® connection (769-6xx/005-000) and snap-in flanges

Inserting a conductor

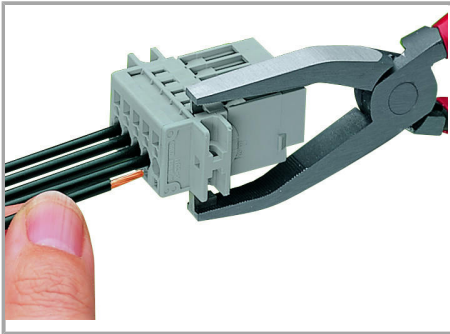

Operating tool

Inserting a conductor via operating tool (example shows a male connector).

Marking

Subject to changes. Please also observe the further product documentation!

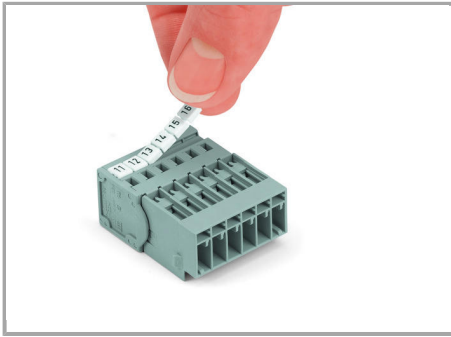

Labeling a male connector with  
CAGE CLAMP® connection via Mini-WSB  
quick markers.

## Product family

### X-COM

[Learn more about the product family.](#)

[Show all products from the family](#)

Subject to changes. Please also observe the further product documentation!