

## Data sheet | Item number: 769-608/002-000

1-conductor male connector; clamping collar; 4 mm<sup>2</sup>; Pin spacing 5 mm; 8-pole; 4,00 mm<sup>2</sup>; gray

[www.wago.com/769-608/002-000](http://www.wago.com/769-608/002-000)

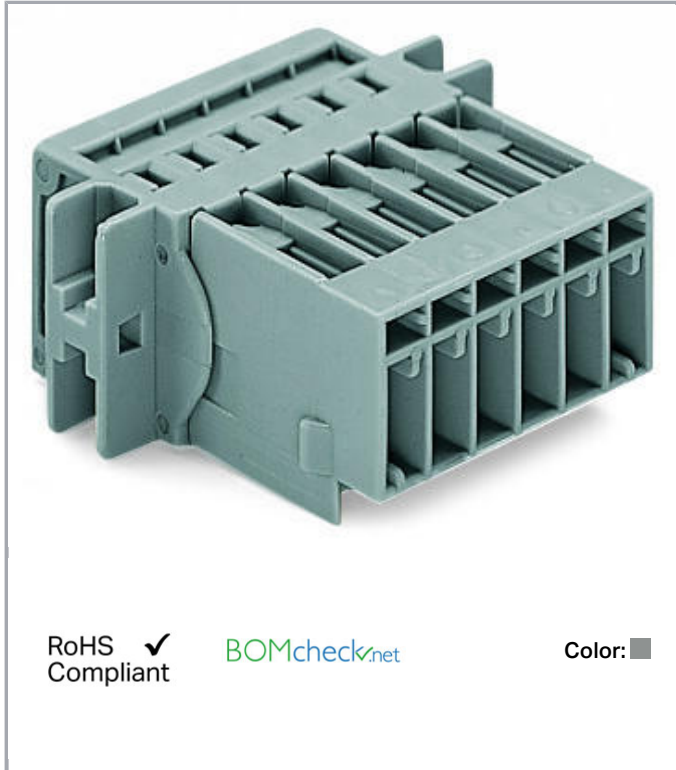

RoHS  Compliant

BOMcheck.net

Color: ■

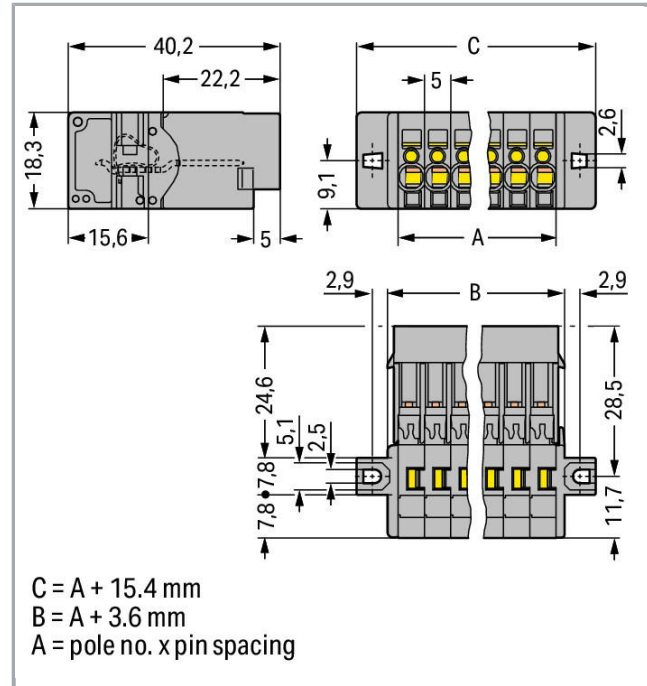

### Data

#### Electrical data

#### Ratings per IEC/EN 60664-1

Rated voltage (III / 3)	500 V
Rated impulse voltage (III / 3)	6 kV
Rated current	32 A
Legend (ratings)	(III / 3) ≙ Overvoltage category III / Pollution degree 3

#### Connection data

Connection technology	CAGE CLAMP®
Actuation type	Operating tool
Connectable conductor materials	Copper

Subject to changes. Please also observe the further product documentation!

WAGO Kontakttechnik GmbH & Co. KG  
Hansastr. 27  
32423 Minden  
Phone: +49571 887-0 | Fax: +49571 887-169  
Email: [info.de@wago.com](mailto:info.de@wago.com) | Web: [www.wago.com](http://www.wago.com)

Do you have any questions about our products?  
We are always happy to take your call at +49 (571) 887-44222.



Nominal cross section	4 mm <sup>2</sup>
Solid conductor	0,08 ... 4 mm <sup>2</sup> / 28 ... 12 AWG
Fine-stranded conductor	0,08 ... 4 mm <sup>2</sup> / 28 ... 12 AWG
Strip length	8 ... 9 mm / 0.31 ... 0.35 inch
No. of poles	8
Total number of connection points	8
Total number of potentials	8
Type of wiring	Front-entry wiring

### Geometrical Data

Pin spacing	5 mm / 0.197 inch
Width	55,4 mm / 2.181 inch
Height from the surface	18,3 mm / 0.72 inch
Depth	40,2 mm / 1.583 inch

### Mechanical data

Mounting type	Mounting flange
---------------	-----------------

### Plug connection

Contact type (pluggable connector)	Male connector/plug
Connector connection type	for conductors

### Material Data

Color	gray
Insulating material	Polyamide 66 (PA 66)
Fire load	0.505 MJ
Weight	24.7 g

### Commercial data

Packaging type	BOX
Country of origin	PL
GTIN	4044918521352
Customs Tariff No.	85366990990





### Approvals / Certificates

#### Country specific Approvals

Subject to changes. Please also observe the further product documentation!

WAGO Kontakttechnik GmbH & Co. KG  
 Hansastr. 27  
 32423 Minden  
 Phone: +49571 887-0 | Fax: +49571 887-169  
 Email: [info.de@wago.com](mailto:info.de@wago.com) | Web: [www.wago.com](http://www.wago.com)



Do you have any questions about our products?  
 We are always happy to take your call at +49 (571) 887-44222.

Logo	Approval	Additional Approval Text	Certificate name
	CCA DEKRA Certification B.V.	EN 60947	NTR NL-7626
	CCA DEKRA Certification B.V.	EN 61984	2190419.02
	CCA DEKRA Certification B.V.	IEC 61984	NL-47799 /A1
	CSA DEKRA Certification B.V.	C22.2 No. 158	1101144
	KEMA/KEUR DEKRA Certification B.V.	EN 60947	2190419.01

## Ship Approvals

Logo	Approval	Additional Approval Text	Certificate name
	DNV GL Det Norske Veritas, Germanischer Lloyd	-	TAE00001V2

## UL-Approvals

Logo	Approval	Additional Approval Text	Certificate name
	UR Underwriters Laboratories Inc.	UL 1977	20151210-E45171
	UR Underwriters Laboratories Inc.	UL 1059	20190731-E45172

Subject to changes. Please also observe the further product documentation!

## Counterpart



Item no.769-108

1-conductor female plug; 4 mm<sup>2</sup>; 8-pole; 4,00 mm<sup>2</sup>; gray

[www.wago.com/769-108](http://www.wago.com/769-108)



Item no.769-108/021-000

1-conductor female plug; Locking lever; 4 mm<sup>2</sup>; 8-pole; 4,00 mm<sup>2</sup>; gray

[www.wago.com/769-108/021-000](http://www.wago.com/769-108/021-000)



Item no.769-128

2-conductor female connector; 4 mm<sup>2</sup>; 8-pole; 4,00 mm<sup>2</sup>; gray

[www.wago.com/769-128](http://www.wago.com/769-128)

## Compatible products

### Female plug

Item no.: 769-101

1-conductor female plug; 4 mm<sup>2</sup>; 1-pole; 4,00 mm<sup>2</sup>; gray

[www.wago.com/769-101](http://www.wago.com/769-101)

Item no.: 769-101/000-016

1-conductor female plug; 4 mm<sup>2</sup>; 1-pole; 4,00 mm<sup>2</sup>; green-yellow

[www.wago.com/769-101/000-016](http://www.wago.com/769-101/000-016)

Item no.: 769-102

1-conductor female plug; 4 mm<sup>2</sup>; 2-pole; 4,00 mm<sup>2</sup>; gray

[www.wago.com/769-102](http://www.wago.com/769-102)

Item no.: 769-102/000-036

1-conductor female plug; 4 mm<sup>2</sup>; 2-pole; 4,00 mm<sup>2</sup>; gray, green-yellow

[www.wago.com/769-102/000-036](http://www.wago.com/769-102/000-036)

Subject to changes. Please also observe the further product documentation!

WAGO Kontakttechnik GmbH & Co. KG

Hansastr. 27

32423 Minden

Phone: +49571 887-0 | Fax: +49571 887-169

Email: [info.de@wago.com](mailto:info.de@wago.com) | Web: [www.wago.com](http://www.wago.com)

Do you have any questions about our products?

We are always happy to take your call at +49 (571) 887-44222.

**Item no.: 769-102/000-037**

1-conductor female plug; 4 mm<sup>2</sup>; 2-pole; 4,00 mm<sup>2</sup>; green-yellow, gray

[www.wago.com/769-102/000-037](http://www.wago.com/769-102/000-037)

**Item no.: 769-103**

1-conductor female plug; 4 mm<sup>2</sup>; 3-pole; 4,00 mm<sup>2</sup>; gray

[www.wago.com/769-103](http://www.wago.com/769-103)

**Item no.: 769-103/000-036**

1-conductor female plug; 4 mm<sup>2</sup>; 3-pole; 4,00 mm<sup>2</sup>; gray, green-yellow

[www.wago.com/769-103/000-036](http://www.wago.com/769-103/000-036)

**Item no.: 769-103/000-037**

1-conductor female plug; 4 mm<sup>2</sup>; 3-pole; 4,00 mm<sup>2</sup>; green-yellow, gray

[www.wago.com/769-103/000-037](http://www.wago.com/769-103/000-037)

**Item no.: 769-103/000-038**

1-conductor female plug; 4 mm<sup>2</sup>; 3-pole; 4,00 mm<sup>2</sup>; gray, blue, green-yellow

[www.wago.com/769-103/000-038](http://www.wago.com/769-103/000-038)

**Item no.: 769-103/000-039**

1-conductor female plug; 4 mm<sup>2</sup>; 3-pole; 4,00 mm<sup>2</sup>; green-yellow, blue, gray

[www.wago.com/769-103/000-039](http://www.wago.com/769-103/000-039)



**Item no.: 769-104**

1-conductor female plug; 4 mm<sup>2</sup>; 4-pole; 4,00 mm<sup>2</sup>; gray

[www.wago.com/769-104](http://www.wago.com/769-104)

**Item no.: 769-104/000-036**

1-conductor female plug; 4 mm<sup>2</sup>; 4-pole; 4,00 mm<sup>2</sup>; gray, green-yellow

[www.wago.com/769-104/000-036](http://www.wago.com/769-104/000-036)

**Item no.: 769-104/000-037**

1-conductor female plug; 4 mm<sup>2</sup>; 4-pole; 4,00 mm<sup>2</sup>; green-yellow, gray

[www.wago.com/769-104/000-037](http://www.wago.com/769-104/000-037)

**Item no.: 769-104/000-038**

1-conductor female plug; 4 mm<sup>2</sup>; 4-pole; 4,00 mm<sup>2</sup>; gray, blue, green-yellow

[www.wago.com/769-104/000-038](http://www.wago.com/769-104/000-038)

**Item no.: 769-104/000-039**

1-conductor female plug; 4 mm<sup>2</sup>; 4-pole; 4,00 mm<sup>2</sup>; green-yellow, blue, gray

[www.wago.com/769-104/000-039](http://www.wago.com/769-104/000-039)

**Item no.: 769-105**

1-conductor female plug; 4 mm<sup>2</sup>; 5-pole; 4,00 mm<sup>2</sup>; gray

[www.wago.com/769-105](http://www.wago.com/769-105)

**Item no.: 769-105/000-036**

1-conductor female plug; 4 mm<sup>2</sup>; 5-pole; 4,00 mm<sup>2</sup>; gray, green-yellow

[www.wago.com/769-105/000-036](http://www.wago.com/769-105/000-036)

**Item no.: 769-105/000-037**

1-conductor female plug; 4 mm<sup>2</sup>; 5-pole; 4,00 mm<sup>2</sup>; green-yellow, gray

[www.wago.com/769-105/000-037](http://www.wago.com/769-105/000-037)

Subject to changes. Please also observe the further product documentation!

WAGO Kontakttechnik GmbH & Co. KG

Hansastr. 27







32423 Minden

Phone: +49571 887-0 | Fax: +49571 887-169

Email: [info.de@wago.com](mailto:info.de@wago.com) | Web: [www.wago.com](http://www.wago.com)

Do you have any questions about our products?

We are always happy to take your call at +49 (571) 887-44222.

	<p><b>Item no.: 769-105/000-038</b> 1-conductor female plug; 4 mm<sup>2</sup>; 5-pole; 4,00 mm<sup>2</sup>; gray, blue, green-yellow</p>	<p><a href="http://www.wago.com/769-105/000-038">www.wago.com/769-105/000-038</a></p>
	<p><b>Item no.: 769-105/000-039</b> 1-conductor female plug; 4 mm<sup>2</sup>; 5-pole; 4,00 mm<sup>2</sup>; green-yellow, blue, gray</p>	<p><a href="http://www.wago.com/769-105/000-039">www.wago.com/769-105/000-039</a></p>
	<p><b>Item no.: 769-106</b> 1-conductor female plug; 4 mm<sup>2</sup>; 6-pole; 4,00 mm<sup>2</sup>; gray</p>	<p><a href="http://www.wago.com/769-106">www.wago.com/769-106</a></p>
	<p><b>Item no.: 769-106/000-006</b> 1-conductor female plug; 4 mm<sup>2</sup>; 6-pole; 4,00 mm<sup>2</sup>; blue</p>	<p><a href="http://www.wago.com/769-106/000-006">www.wago.com/769-106/000-006</a></p>
	<p><b>Item no.: 769-106/000-036</b> 1-conductor female plug; 4 mm<sup>2</sup>; 6-pole; 4,00 mm<sup>2</sup>; gray, green-yellow</p>	<p><a href="http://www.wago.com/769-106/000-036">www.wago.com/769-106/000-036</a></p>
	<p><b>Item no.: 769-106/000-037</b> 1-conductor female plug; 4 mm<sup>2</sup>; 6-pole; 4,00 mm<sup>2</sup>; green-yellow, gray</p>	<p><a href="http://www.wago.com/769-106/000-037">www.wago.com/769-106/000-037</a></p>
	<p><b>Item no.: 769-106/000-038</b> 1-conductor female plug; 4 mm<sup>2</sup>; 6-pole; 4,00 mm<sup>2</sup>; gray, blue, green-yellow</p>	<p><a href="http://www.wago.com/769-106/000-038">www.wago.com/769-106/000-038</a></p>
	<p><b>Item no.: 769-106/000-039</b> 1-conductor female plug; 4 mm<sup>2</sup>; 6-pole; 4,00 mm<sup>2</sup>; green-yellow, blue, gray</p>	<p><a href="http://www.wago.com/769-106/000-039">www.wago.com/769-106/000-039</a></p>
	<p><b>Item no.: 769-107</b> 1-conductor female plug; 4 mm<sup>2</sup>; 7-pole; 4,00 mm<sup>2</sup>; gray</p>	<p><a href="http://www.wago.com/769-107">www.wago.com/769-107</a></p>
	<p><b>Item no.: 769-107/000-036</b> 1-conductor female plug; 4 mm<sup>2</sup>; 7-pole; 4,00 mm<sup>2</sup>; gray, green-yellow</p>	<p><a href="http://www.wago.com/769-107/000-036">www.wago.com/769-107/000-036</a></p>
	<p><b>Item no.: 769-107/000-037</b> 1-conductor female plug; 4 mm<sup>2</sup>; 7-pole; 4,00 mm<sup>2</sup>; green-yellow, gray</p>	<p><a href="http://www.wago.com/769-107/000-037">www.wago.com/769-107/000-037</a></p>
	<p><b>Item no.: 769-107/000-038</b> 1-conductor female plug; 4 mm<sup>2</sup>; 7-pole; 4,00 mm<sup>2</sup>; gray, blue, green-yellow</p>	<p><a href="http://www.wago.com/769-107/000-038">www.wago.com/769-107/000-038</a></p>
	<p><b>Item no.: 769-107/000-039</b> 1-conductor female plug; 4 mm<sup>2</sup>; 7-pole; 4,00 mm<sup>2</sup>; green-yellow, blue, gray</p>	<p><a href="http://www.wago.com/769-107/000-039">www.wago.com/769-107/000-039</a></p>
	<p><b>Item no.: 769-108/000-036</b> 1-conductor female plug; 4 mm<sup>2</sup>; 8-pole; 4,00 mm<sup>2</sup>; gray, green-yellow</p>	<p><a href="http://www.wago.com/769-108/000-036">www.wago.com/769-108/000-036</a></p>

Subject to changes. Please also observe the further product documentation!



**Item no.: 769-108/000-037**  
1-conductor female plug; 4 mm<sup>2</sup>; 8-pole; 4,00 mm<sup>2</sup>; green-yellow, gray

[www.wago.com/769-108/000-037](http://www.wago.com/769-108/000-037)



**Item no.: 769-108/000-038**  
1-conductor female plug; 4 mm<sup>2</sup>; 8-pole; 4,00 mm<sup>2</sup>; gray, blue, green-yellow

[www.wago.com/769-108/000-038](http://www.wago.com/769-108/000-038)

**Item no.: 769-108/000-039**  
1-conductor female plug; 4 mm<sup>2</sup>; 8-pole; 4,00 mm<sup>2</sup>; green-yellow, blue, gray

[www.wago.com/769-108/000-039](http://www.wago.com/769-108/000-039)



**Item no.: 769-121**  
2-conductor female connector; 4 mm<sup>2</sup>; 1-pole; 4,00 mm<sup>2</sup>; gray

[www.wago.com/769-121](http://www.wago.com/769-121)



**Item no.: 769-122**  
2-conductor female connector; 4 mm<sup>2</sup>; 2-pole; 4,00 mm<sup>2</sup>; gray

[www.wago.com/769-122](http://www.wago.com/769-122)



**Item no.: 769-123**  
2-conductor female connector; 4 mm<sup>2</sup>; 3-pole; 4,00 mm<sup>2</sup>; gray

[www.wago.com/769-123](http://www.wago.com/769-123)



**Item no.: 769-124**  
2-conductor female connector; 4 mm<sup>2</sup>; 4-pole; 4,00 mm<sup>2</sup>; gray

[www.wago.com/769-124](http://www.wago.com/769-124)



**Item no.: 769-125**  
2-conductor female connector; 4 mm<sup>2</sup>; 5-pole; 4,00 mm<sup>2</sup>; gray

[www.wago.com/769-125](http://www.wago.com/769-125)



**Item no.: 769-126**  
2-conductor female connector; 4 mm<sup>2</sup>; 6-pole; 4,00 mm<sup>2</sup>; gray

[www.wago.com/769-126](http://www.wago.com/769-126)



**Item no.: 769-127**  
2-conductor female connector; 4 mm<sup>2</sup>; 7-pole; 4,00 mm<sup>2</sup>; gray

[www.wago.com/769-127](http://www.wago.com/769-127)

#### Marking accessories

**Item no.: 2009-145**  
Mini-WSB Inline; for Smart Printer; 1700 pieces on roll; stretchable 5 - 5.2 mm; plain; snap-on type; white [www.wago.com/2009-145](http://www.wago.com/2009-145)





**Item no.: 2009-145/000-002**  
Mini-WSB Inline; for Smart Printer; 1700 pieces on roll; stretchable 5 - 5.2 mm; plain; snap-on type; white [www.wago.com/2009-145/000-002](http://www.wago.com/2009-145/000-002)

**Item no.: 2009-145/000-005**  
Mini-WSB Inline; for Smart Printer; 1700 pieces on roll; stretchable 5 - 5.2 mm; plain; snap-on type; red [www.wago.com/2009-145/000-005](http://www.wago.com/2009-145/000-005)

**Item no.: 2009-145/000-006**  
Mini-WSB Inline; for Smart Printer; 1700 pieces on roll; stretchable 5 - 5.2 mm; plain; snap-on type; blue [www.wago.com/2009-145/000-006](http://www.wago.com/2009-145/000-006)

**Item no.: 2009-145/000-007**  
Mini-WSB Inline; for Smart Printer; 1700 pieces on roll; stretchable 5 - 5.2 mm; plain; snap-on type; white [www.wago.com/2009-145/000-007](http://www.wago.com/2009-145/000-007)

Subject to changes. Please also observe the further product documentation!

<p><b>Item no.: 2009-145/000-012</b> Mini-WSB Inline; for Smart Printer; 1700 pieces on roll; stretchable 5 - 5.2 mm; plain; snap-on type; orange</p>	<p><a href="http://www.wago.com/2009-145/000-012">www.wago.com/2009-145/000-012</a></p>
<p><b>Item no.: 2009-145/000-023</b> Mini-WSB Inline; for Smart Printer; 1700 pieces on roll; stretchable 5 - 5.2 mm; plain; snap-on type; green</p>	<p><a href="http://www.wago.com/2009-145/000-023">www.wago.com/2009-145/000-023</a></p>
<p><b>Item no.: 2009-145/000-024</b> Mini-WSB Inline; for Smart Printer; 1700 pieces on roll; stretchable 5 - 5.2 mm; plain; snap-on type; violet</p>	<p><a href="http://www.wago.com/2009-145/000-024">www.wago.com/2009-145/000-024</a></p>
<p><b>Item no.: 210-831</b> Marking strips; on reel; 2.3 mm wide; plain; Self-adhesive; white</p>	<p><a href="http://www.wago.com/210-831">www.wago.com/210-831</a></p>
<p><b>Item no.: 210-832</b> Marking strips; on reel; 3 mm wide; plain; Self-adhesive; white</p>	<p><a href="http://www.wago.com/210-832">www.wago.com/210-832</a></p>
<p><b>Item no.: 210-833</b> Marking strips; on reel; 6 mm wide; plain; Self-adhesive; white</p>	<p><a href="http://www.wago.com/210-833">www.wago.com/210-833</a></p>
<p><b>Item no.: 210-834</b> Marking strips; on reel; 5 mm wide; plain; Self-adhesive; white</p>	<p><a href="http://www.wago.com/210-834">www.wago.com/210-834</a></p>
<p> <b>Item no.: 248-501</b> Miniature WSB Quick marking system; plain; Marker width 5 mm; 10 strips with 10 markers per card</p>	<p><a href="http://www.wago.com/248-501">www.wago.com/248-501</a></p>
<p> <b>Item no.: 248-501/000-002</b> Mini-WSB marking card; as card; not stretchable; plain; snap-on type; yellow</p>	<p><a href="http://www.wago.com/248-501/000-002">www.wago.com/248-501/000-002</a></p>
<p><b>Item no.: 248-501/000-005</b> Mini-WSB marking card; as card; not stretchable; plain; snap-on type; red</p>	<p><a href="http://www.wago.com/248-501/000-005">www.wago.com/248-501/000-005</a></p>
<p> <b>Item no.: 248-501/000-006</b> Mini-WSB marking card; as card; not stretchable; plain; snap-on type; blue</p>	<p><a href="http://www.wago.com/248-501/000-006">www.wago.com/248-501/000-006</a></p>
<p><b>Item no.: 248-501/000-007</b> Mini-WSB marking card; as card; not stretchable; plain; snap-on type; gray</p>	<p><a href="http://www.wago.com/248-501/000-007">www.wago.com/248-501/000-007</a></p>
<p><b>Item no.: 248-501/000-012</b> Mini-WSB marking card; as card; not stretchable; plain; snap-on type; orange</p>	<p><a href="http://www.wago.com/248-501/000-012">www.wago.com/248-501/000-012</a></p>
<p><b>Item no.: 248-501/000-017</b> Mini-WSB marking card; as card; not stretchable; plain; snap-on type; light green</p>	<p><a href="http://www.wago.com/248-501/000-017">www.wago.com/248-501/000-017</a></p>
<p> <b>Item no.: 248-501/000-023</b> Mini-WSB marking card; as card; not stretchable; plain; snap-on type; green</p>	<p><a href="http://www.wago.com/248-501/000-023">www.wago.com/248-501/000-023</a></p>

Subject to changes. Please also observe the further product documentation!



**Item no.: 248-501/000-024**

Mini-WSB marking card; as card; not stretchable; plain; snap-on type; violet

[www.wago.com/248-501/000-024](http://www.wago.com/248-501/000-024)**Protective Warning Marker****Item no.: 280-415**

Protective warning marker; with high-voltage symbol, black; for 5 terminal blocks; yellow

[www.wago.com/280-415](http://www.wago.com/280-415)**Coding****Item no.: 769-435**

Coding pin; for coding of female plugs; for carrier terminal blocks / male connectors; orange

[www.wago.com/769-435](http://www.wago.com/769-435)**Insulation stop****Item no.: 769-470**Insulation stop; 0.08 - 0.2 mm<sup>2</sup> "s" (0.14 mm<sup>2</sup> "f-st"); 5 pieces/strip; white[www.wago.com/769-470](http://www.wago.com/769-470)**Item no.: 769-471**Insulation stop; 0.25 - 0.5 mm<sup>2</sup>; 5 pieces/strip; light gray[www.wago.com/769-471](http://www.wago.com/769-471)**Item no.: 769-472**Insulation stop; 0.75 - 1 mm<sup>2</sup>; 5 pieces/strip; dark gray[www.wago.com/769-472](http://www.wago.com/769-472)**tools****Item no.: 210-490**

Operating tool

[www.wago.com/210-490](http://www.wago.com/210-490)**Item no.: 769-434**

Push-button; loose

[www.wago.com/769-434](http://www.wago.com/769-434)**Strain relief plate****Item no.: 769-410**

Strain relief plate; gray

[www.wago.com/769-410](http://www.wago.com/769-410)**Item no.: 769-413**

Strain relief plate; gray

[www.wago.com/769-413](http://www.wago.com/769-413)**ferrule****Item no.: 216-101**Ferrule; Sleeve for 0.5 mm<sup>2</sup> / AWG 22; uninsulated; electro-tin plated[www.wago.com/216-101](http://www.wago.com/216-101)**Item no.: 216-102**Ferrule; Sleeve for 0.75 mm<sup>2</sup> / AWG 20; uninsulated; electro-tin plated[www.wago.com/216-102](http://www.wago.com/216-102)**Item no.: 216-103**Ferrule; Sleeve for 1 mm<sup>2</sup> / AWG 18; uninsulated; electro-tin plated[www.wago.com/216-103](http://www.wago.com/216-103)**Item no.: 216-104**Ferrule; Sleeve for 1.5 mm<sup>2</sup> / AWG 16; uninsulated; electro-tin plated[www.wago.com/216-104](http://www.wago.com/216-104)**Item no.: 216-201**Ferrule; Sleeve for 0.5 mm<sup>2</sup> / 20 AWG; insulated; electro-tin plated; white[www.wago.com/216-201](http://www.wago.com/216-201)

Subject to changes. Please also observe the further product documentation!

WAGO Kontakttechnik GmbH &amp; Co. KG

Hansastr. 27

32423 Minden

Phone: +49571 887-0 | Fax: +49571 887-169

Email: [info.de@wago.com](mailto:info.de@wago.com) | Web: [www.wago.com](http://www.wago.com)

Do you have any questions about our products?

We are always happy to take your call at +49 (571) 887-44222.



**Item no.: 216-202**  
Ferrule; Sleeve for 0.75 mm<sup>2</sup> / 18 AWG; insulated; electro-tin plated; gray

[www.wago.com/216-202](http://www.wago.com/216-202)

**Item no.: 216-203**  
Ferrule; Sleeve for 1 mm<sup>2</sup> / AWG 18; insulated; electro-tin plated; red

[www.wago.com/216-203](http://www.wago.com/216-203)

**Item no.: 216-204**  
Ferrule; Sleeve for 1.5 mm<sup>2</sup> / AWG 16; insulated; electro-tin plated; black

[www.wago.com/216-204](http://www.wago.com/216-204)

**Item no.: 216-206**  
Ferrule; Sleeve for 2.5 mm<sup>2</sup> / AWG 14; insulated; electro-tin plated; blue

[www.wago.com/216-206](http://www.wago.com/216-206)

#### assembling



**Item no.: 769-499**  
Fixing screw M2.5 x 16; and hexagon nut M2.5

[www.wago.com/769-499](http://www.wago.com/769-499)

## Downloads

### Documentation

#### Additional Information

Technical explanations	Apr 3, 2019	pdf 2.1 MB	Download
------------------------	-------------	---------------	----------

## CAD/CAE-Data

### CAD data

2D/3D Models 769-608/002-000	URL	Download
------------------------------	-----	----------

### CAE data

EPLAN Data Portal 769-608/002-000	URL	Download
-----------------------------------	-----	----------

WSCAD Universe 769-608/002-000	URL	Download
--------------------------------	-----	----------

## Installation Notes

### Assembly

Subject to changes. Please also observe the further product documentation!

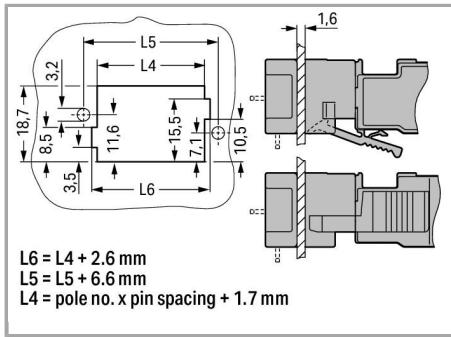

Cutout

Male headers with solder pins and fixing flanges

Inserting a conductor

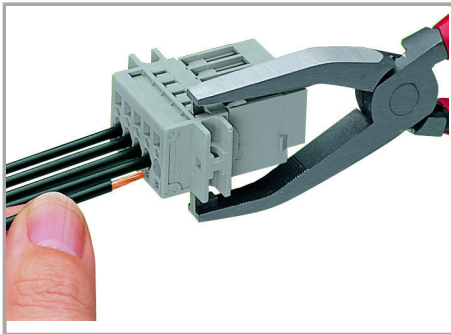

Operating tool

Inserting a conductor via operating tool  
(example shows a male connector).

Application

Subject to changes. Please also observe the further product documentation!

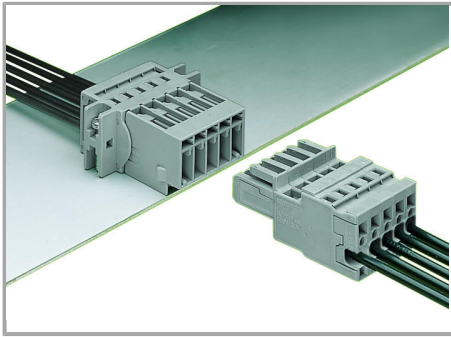

Male connector with CAGE CLAMP® and mounting flanges

1-connector female plug, straight

### Marking

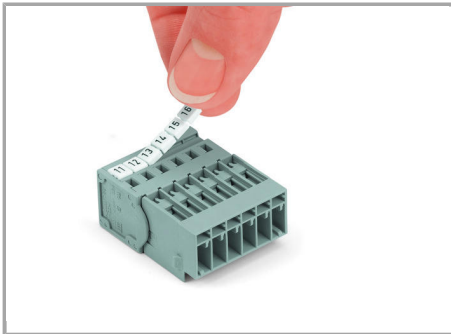

Labeling a male connector with CAGE CLAMP® connection via Mini-WSB quick markers.

### Product family

#### X-COM

[Learn more about the product family.](#)

[Show all products from the family](#)

Subject to changes. Please also observe the further product documentation!