

## Data sheet | Item number: 769-238/281-410

1-conductor/1-pin component carrier terminal block; with diode 1N4007; anode, left side; for DIN-rail 35 x 15 and 35 x 7.5; 4 mm<sup>2</sup>; CAGE CLAMP®; 4,00 mm<sup>2</sup>; gray

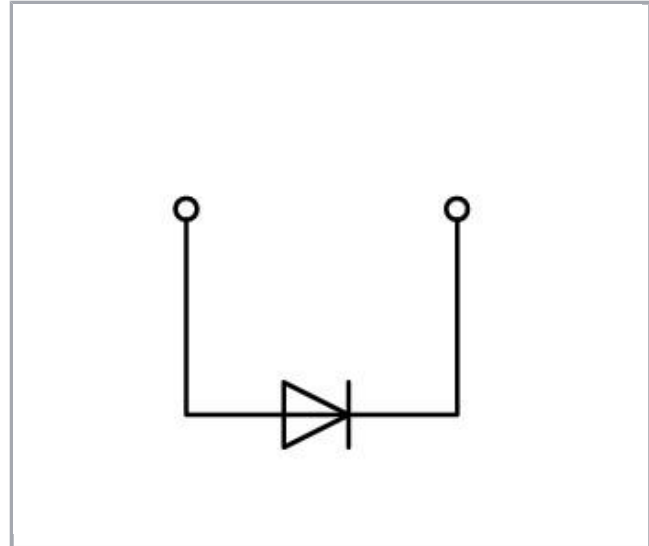

[www.wago.com/769-238/281-410](http://www.wago.com/769-238/281-410)

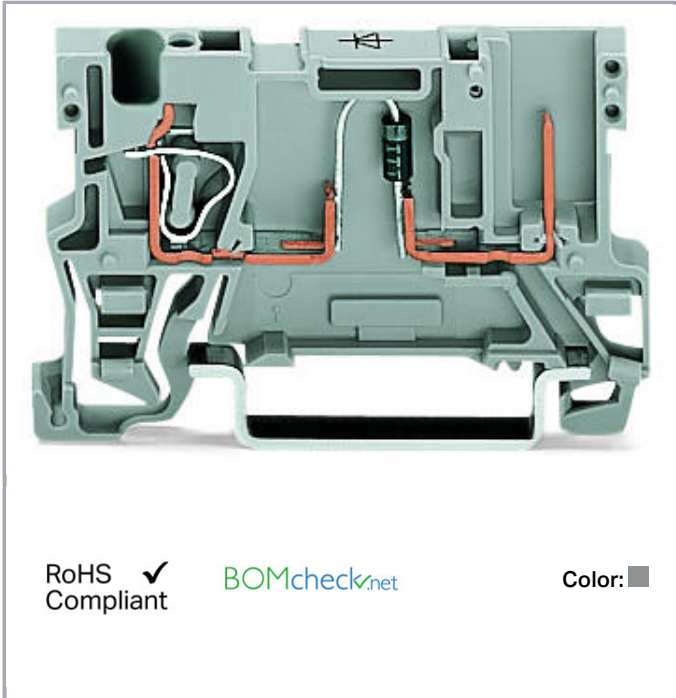

### Data

#### Electrical data

Nominal voltage	250 V
Reverse voltage	1,000 V

#### Ratings per IEC/EN 60664-1

Rated current	0.5 A
---------------	-------

#### Connection data

Connection technology	CAGE CLAMP®
Actuation type	Open Tool Slot
Connectable conductor materials	Copper
Nominal cross section	4 mm <sup>2</sup>
Solid conductor	0.08 ... 4 mm <sup>2</sup> / 28 ... 12 AWG
Fine-stranded conductor	0.08 ... 4 mm <sup>2</sup> / 28 ... 12 AWG

Subject to changes. Please also observe the further product documentation!

WAGO Kontakttechnik GmbH & Co. KG  
Hansastr. 27  
32423 Minden  
Phone: +49571 887-0 | Fax: +49571 887-169  
Email: [info.de@wago.com](mailto:info.de@wago.com) | Web: [www.wago.com](http://www.wago.com)

Do you have any questions about our products?  
We are always happy to take your call at +49 (571) 887-44222.



Strip length	8 ... 9 mm / 0.31 ... 0.35 inch
Total number of connection points	1
Total number of potentials	1
Number of levels	1
Type of wiring	Front-entry wiring

### Geometrical Data

Width	5 mm / 0.197 inch
Height from upper-edge of DIN-35 rail	28.5 mm / 1.122 inch
Depth	52.5 mm / 2.067 inch

### Mechanical data

Design	horizontal
Type of mounting	DIN-35 rail
Marking level	Center marking

### Material Data

Color	gray
Insulating material	Polyamide 66 (PA 66)
Fire load	0.109 MJ
Weight	5.1 g

### Commercial data

Product Group	18 (X-COM-System)
Packaging type	BOX
Country of origin	DE
GTIN	4045454619510
Customs Tariff No.	85369010000

### Approvals / Certificates

#### Country specific Approvals

Logo	Approval	Additional Approval Text	Certificate name
	CCA DEKRA Certification B.V.	EN 60947	NTR NL-7626

Subject to changes. Please also observe the further product documentation!

WAGO Kontakttechnik GmbH & Co. KG  
 Hansastr. 27  
 32423 Minden  
 Phone: +49571 887-0 | Fax: +49571 887-169  
 Email: [info.de@wago.com](mailto:info.de@wago.com) | Web: [www.wago.com](http://www.wago.com)

Do you have any questions about our products?  
 We are always happy to take your call at +49 (571) 887-44222.



CSA  
DEKRA Certification B.V.

C22.2 No. 158

1101144





KEMA/KEUR  
DEKRA Certification B.V.

EN 60947

2190419.01

### Ship Approvals

Logo	Approval	Additional Approval Text	Certificate name
	<b>ABS</b> American Bureau of Shipping	EN 60947	20- HG1941090- PDA
	<b>DNV GL</b> Det Norske Veritas, Germanischer Lloyd	-	TAE00001V2

### Counterpart

### Compatible products

#### Protective Warning Marker

**Item no.: 280-415**  
Protective warning marker; with high-voltage symbol, black; for 5 terminal blocks; yellow

[www.wago.com/280-415](http://www.wago.com/280-415)

#### ferrule











**Item no.: 216-101**  
Ferrule; Sleeve for 0.5 mm<sup>2</sup> / AWG 22; uninsulated; electro-tin plated

[www.wago.com/216-101](http://www.wago.com/216-101)











Subject to changes. Please also observe the further product documentation!

WAGO Kontakttechnik GmbH & Co. KG  
Hansastr. 27  
32423 Minden  
Phone: +49571 887-0 | Fax: +49571 887-169  
Email: [info.de@wago.com](mailto:info.de@wago.com) | Web: [www.wago.com](http://www.wago.com)

Do you have any questions about our products?  
We are always happy to take your call at +49 (571) 887-44222.

	<b>Item no.: 216-102</b> Ferrule; Sleeve for 0.75 mm <sup>2</sup> / AWG 20; uninsulated; electro-tin plated	<a href="http://www.wago.com/216-102">www.wago.com/216-102</a>
	<b>Item no.: 216-103</b> Ferrule; Sleeve for 1 mm <sup>2</sup> / AWG 18; uninsulated; electro-tin plated	<a href="http://www.wago.com/216-103">www.wago.com/216-103</a>
	<b>Item no.: 216-104</b> Ferrule; Sleeve for 1.5 mm <sup>2</sup> / AWG 16; uninsulated; electro-tin plated	<a href="http://www.wago.com/216-104">www.wago.com/216-104</a>
	<b>Item no.: 216-201</b> Ferrule; Sleeve for 0.5 mm <sup>2</sup> / 20 AWG; insulated; electro-tin plated; white	<a href="http://www.wago.com/216-201">www.wago.com/216-201</a>
	<b>Item no.: 216-202</b> Ferrule; Sleeve for 0.75 mm <sup>2</sup> / 18 AWG; insulated; electro-tin plated; gray	<a href="http://www.wago.com/216-202">www.wago.com/216-202</a>
	<b>Item no.: 216-203</b> Ferrule; Sleeve for 1 mm <sup>2</sup> / AWG 18; insulated; electro-tin plated; red	<a href="http://www.wago.com/216-203">www.wago.com/216-203</a>
	<b>Item no.: 216-204</b> Ferrule; Sleeve for 1.5 mm <sup>2</sup> / AWG 16; insulated; electro-tin plated; black	<a href="http://www.wago.com/216-204">www.wago.com/216-204</a>
	<b>Item no.: 216-206</b> Ferrule; Sleeve for 2.5 mm <sup>2</sup> / AWG 14; insulated; electro-tin plated; blue	<a href="http://www.wago.com/216-206">www.wago.com/216-206</a>
	<b>Item no.: 216-301</b> Ferrule; Sleeve for 0.25 mm <sup>2</sup> / AWG 24; insulated; electro-tin plated; yellow	<a href="http://www.wago.com/216-301">www.wago.com/216-301</a>
	<b>Item no.: 216-302</b> Ferrule; Sleeve for 0.34 mm <sup>2</sup> / 22 AWG; insulated; electro-tin plated; green	<a href="http://www.wago.com/216-302">www.wago.com/216-302</a>
<b>End plate</b>		
	<b>Item no.: 769-307</b> End and intermediate plate; 1.1 mm thick; gray	<a href="http://www.wago.com/769-307">www.wago.com/769-307</a>
	<b>Item no.: 769-308</b> End and intermediate plate; 1.1 mm thick; orange	<a href="http://www.wago.com/769-308">www.wago.com/769-308</a>
<b>Female plug</b>		
	<b>Item no.: 769-101</b> 1-conductor female plug; 4 mm <sup>2</sup> ; 1-pole; 4,00 mm <sup>2</sup> ; gray	<a href="http://www.wago.com/769-101">www.wago.com/769-101</a>
	<b>Item no.: 769-101/000-006</b> 1-conductor female plug; 4 mm <sup>2</sup> ; 1-pole; 4,00 mm <sup>2</sup> ; blue	<a href="http://www.wago.com/769-101/000-006">www.wago.com/769-101/000-006</a>
	<b>Item no.: 769-101/000-016</b> 1-conductor female plug; 4 mm <sup>2</sup> ; 1-pole; 4,00 mm <sup>2</sup> ; green-yellow	<a href="http://www.wago.com/769-101/000-016">www.wago.com/769-101/000-016</a>
	<b>Item no.: 769-101/022-000</b> 1-conductor female plug; angled; 4 mm <sup>2</sup> ; 1-pole; 4,00 mm <sup>2</sup> ; gray	<a href="http://www.wago.com/769-101/022-000">www.wago.com/769-101/022-000</a>

Subject to changes. Please also observe the further product documentation!

	<p><b>Item no.: 769-101/022-016</b> 1-conductor female plug; angled; 4 mm<sup>2</sup>; 1-pole; 4,00 mm<sup>2</sup>; green-yellow</p>	<a href="http://www.wago.com/769-101/022-016">www.wago.com/769-101/022-016</a>
	<p><b>Item no.: 769-102</b> 1-conductor female plug; 4 mm<sup>2</sup>; 2-pole; 4,00 mm<sup>2</sup>; gray</p>	<a href="http://www.wago.com/769-102">www.wago.com/769-102</a>
	<p><b>Item no.: 769-102/000-006</b> 1-conductor female plug; 4 mm<sup>2</sup>; 2-pole; 4,00 mm<sup>2</sup>; blue</p>	<a href="http://www.wago.com/769-102/000-006">www.wago.com/769-102/000-006</a>
	<p><b>Item no.: 769-102/000-036</b> 1-conductor female plug; 4 mm<sup>2</sup>; 2-pole; 4,00 mm<sup>2</sup>; gray, green-yellow</p>	<a href="http://www.wago.com/769-102/000-036">www.wago.com/769-102/000-036</a>
	<p><b>Item no.: 769-102/000-037</b> 1-conductor female plug; 4 mm<sup>2</sup>; 2-pole; 4,00 mm<sup>2</sup>; green-yellow, gray</p>	<a href="http://www.wago.com/769-102/000-037">www.wago.com/769-102/000-037</a>
	<p><b>Item no.: 769-102/022-000</b> 1-conductor female plug; angled; 4 mm<sup>2</sup>; 2-pole; 4,00 mm<sup>2</sup>; gray</p>	<a href="http://www.wago.com/769-102/022-000">www.wago.com/769-102/022-000</a>
	<p><b>Item no.: 769-103</b> 1-conductor female plug; 4 mm<sup>2</sup>; 3-pole; 4,00 mm<sup>2</sup>; gray</p>	<a href="http://www.wago.com/769-103">www.wago.com/769-103</a>
	<p><b>Item no.: 769-103/000-006</b> 1-conductor female plug; 4 mm<sup>2</sup>; 3-pole; 4,00 mm<sup>2</sup>; blue</p>	<a href="http://www.wago.com/769-103/000-006">www.wago.com/769-103/000-006</a>
	<p><b>Item no.: 769-103/000-036</b> 1-conductor female plug; 4 mm<sup>2</sup>; 3-pole; 4,00 mm<sup>2</sup>; gray, green-yellow</p>	<a href="http://www.wago.com/769-103/000-036">www.wago.com/769-103/000-036</a>
	<p><b>Item no.: 769-103/000-037</b> 1-conductor female plug; 4 mm<sup>2</sup>; 3-pole; 4,00 mm<sup>2</sup>; green-yellow, gray</p>	<a href="http://www.wago.com/769-103/000-037">www.wago.com/769-103/000-037</a>
	<p><b>Item no.: 769-103/000-038</b> 1-conductor female plug; 4 mm<sup>2</sup>; 3-pole; 4,00 mm<sup>2</sup>; gray, blue, green-yellow</p>	<a href="http://www.wago.com/769-103/000-038">www.wago.com/769-103/000-038</a>
	<p><b>Item no.: 769-103/000-039</b> 1-conductor female plug; 4 mm<sup>2</sup>; 3-pole; 4,00 mm<sup>2</sup>; green-yellow, blue, gray</p>	<a href="http://www.wago.com/769-103/000-039">www.wago.com/769-103/000-039</a>
	<p><b>Item no.: 769-103/022-000</b> 1-conductor female plug; angled; 4 mm<sup>2</sup>; 3-pole; 4,00 mm<sup>2</sup>; gray</p>	<a href="http://www.wago.com/769-103/022-000">www.wago.com/769-103/022-000</a>
	<p><b>Item no.: 769-104</b> 1-conductor female plug; 4 mm<sup>2</sup>; 4-pole; 4,00 mm<sup>2</sup>; gray</p>	<a href="http://www.wago.com/769-104">www.wago.com/769-104</a>

Subject to changes. Please also observe the further product documentation!



**Item no.: 769-104/000-006**

1-conductor female plug; 4 mm<sup>2</sup>; 4-pole; 4,00 mm<sup>2</sup>; blue

[www.wago.com/769-104/000-006](http://www.wago.com/769-104/000-006)



**Item no.: 769-104/000-036**

1-conductor female plug; 4 mm<sup>2</sup>; 4-pole; 4,00 mm<sup>2</sup>; gray, green-yellow

[www.wago.com/769-104/000-036](http://www.wago.com/769-104/000-036)



**Item no.: 769-104/000-037**

1-conductor female plug; 4 mm<sup>2</sup>; 4-pole; 4,00 mm<sup>2</sup>; green-yellow, gray

[www.wago.com/769-104/000-037](http://www.wago.com/769-104/000-037)

**Item no.: 769-104/000-038**

1-conductor female plug; 4 mm<sup>2</sup>; 4-pole; 4,00 mm<sup>2</sup>; gray, blue, green-yellow

[www.wago.com/769-104/000-038](http://www.wago.com/769-104/000-038)

**Item no.: 769-104/000-039**

1-conductor female plug; 4 mm<sup>2</sup>; 4-pole; 4,00 mm<sup>2</sup>; green-yellow, blue, gray

[www.wago.com/769-104/000-039](http://www.wago.com/769-104/000-039)

**Item no.: 769-104/022-000**

1-conductor female plug; angled; 4 mm<sup>2</sup>; 4-pole; 4,00 mm<sup>2</sup>; gray

[www.wago.com/769-104/022-000](http://www.wago.com/769-104/022-000)



**Item no.: 769-105**

1-conductor female plug; 4 mm<sup>2</sup>; 5-pole; 4,00 mm<sup>2</sup>; gray

[www.wago.com/769-105](http://www.wago.com/769-105)



**Item no.: 769-105/000-006**

1-conductor female plug; 4 mm<sup>2</sup>; 5-pole; 4,00 mm<sup>2</sup>; blue

[www.wago.com/769-105/000-006](http://www.wago.com/769-105/000-006)



**Item no.: 769-105/000-036**

1-conductor female plug; 4 mm<sup>2</sup>; 5-pole; 4,00 mm<sup>2</sup>; gray, green-yellow

[www.wago.com/769-105/000-036](http://www.wago.com/769-105/000-036)

**Item no.: 769-105/000-037**

1-conductor female plug; 4 mm<sup>2</sup>; 5-pole; 4,00 mm<sup>2</sup>; green-yellow, gray

[www.wago.com/769-105/000-037](http://www.wago.com/769-105/000-037)



**Item no.: 769-105/000-038**

1-conductor female plug; 4 mm<sup>2</sup>; 5-pole; 4,00 mm<sup>2</sup>; gray, blue, green-yellow

[www.wago.com/769-105/000-038](http://www.wago.com/769-105/000-038)



**Item no.: 769-105/000-039**

1-conductor female plug; 4 mm<sup>2</sup>; 5-pole; 4,00 mm<sup>2</sup>; green-yellow, blue, gray

[www.wago.com/769-105/000-039](http://www.wago.com/769-105/000-039)



**Item no.: 769-105/022-000**

1-conductor female plug; angled; 4 mm<sup>2</sup>; 5-pole; 4,00 mm<sup>2</sup>; gray

[www.wago.com/769-105/022-000](http://www.wago.com/769-105/022-000)

**Item no.: 769-106**

1-conductor female plug; 4 mm<sup>2</sup>; 6-pole; 4,00 mm<sup>2</sup>; gray

[www.wago.com/769-106](http://www.wago.com/769-106)

Subject to changes. Please also observe the further product documentation!

WAGO Kontakttechnik GmbH & Co. KG

Hansastr. 27

32423 Minden

Phone: +49571 887-0 | Fax: +49571 887-169

Email: [info.de@wago.com](mailto:info.de@wago.com) | Web: [www.wago.com](http://www.wago.com)

Do you have any questions about our products?

We are always happy to take your call at +49 (571) 887-44222.



**Item no.: 769-106/000-006**  
1-conductor female plug; 4 mm<sup>2</sup>; 6-pole; 4,00 mm<sup>2</sup>; blue

[www.wago.com/769-106/000-006](http://www.wago.com/769-106/000-006)



**Item no.: 769-106/000-036**  
1-conductor female plug; 4 mm<sup>2</sup>; 6-pole; 4,00 mm<sup>2</sup>; gray, green-yellow

[www.wago.com/769-106/000-036](http://www.wago.com/769-106/000-036)

**Item no.: 769-106/000-037**  
1-conductor female plug; 4 mm<sup>2</sup>; 6-pole; 4,00 mm<sup>2</sup>; green-yellow, gray

[www.wago.com/769-106/000-037](http://www.wago.com/769-106/000-037)

**Item no.: 769-106/000-038**  
1-conductor female plug; 4 mm<sup>2</sup>; 6-pole; 4,00 mm<sup>2</sup>; gray, blue, green-yellow

[www.wago.com/769-106/000-038](http://www.wago.com/769-106/000-038)

**Item no.: 769-106/000-039**  
1-conductor female plug; 4 mm<sup>2</sup>; 6-pole; 4,00 mm<sup>2</sup>; green-yellow, blue, gray

[www.wago.com/769-106/000-039](http://www.wago.com/769-106/000-039)



**Item no.: 769-106/022-000**  
1-conductor female plug; angled; 4 mm<sup>2</sup>; 6-pole; 4,00 mm<sup>2</sup>; gray

[www.wago.com/769-106/022-000](http://www.wago.com/769-106/022-000)



**Item no.: 769-107**  
1-conductor female plug; 4 mm<sup>2</sup>; 7-pole; 4,00 mm<sup>2</sup>; gray

[www.wago.com/769-107](http://www.wago.com/769-107)

**Item no.: 769-107/000-006**  
1-conductor female plug; 4 mm<sup>2</sup>; 7-pole; 4,00 mm<sup>2</sup>; blue

[www.wago.com/769-107/000-006](http://www.wago.com/769-107/000-006)



**Item no.: 769-107/000-036**  
1-conductor female plug; 4 mm<sup>2</sup>; 7-pole; 4,00 mm<sup>2</sup>; gray, green-yellow

[www.wago.com/769-107/000-036](http://www.wago.com/769-107/000-036)



**Item no.: 769-107/000-037**  
1-conductor female plug; 4 mm<sup>2</sup>; 7-pole; 4,00 mm<sup>2</sup>; green-yellow, gray

[www.wago.com/769-107/000-037](http://www.wago.com/769-107/000-037)

**Item no.: 769-107/000-038**  
1-conductor female plug; 4 mm<sup>2</sup>; 7-pole; 4,00 mm<sup>2</sup>; gray, blue, green-yellow

[www.wago.com/769-107/000-038](http://www.wago.com/769-107/000-038)

**Item no.: 769-107/000-039**  
1-conductor female plug; 4 mm<sup>2</sup>; 7-pole; 4,00 mm<sup>2</sup>; green-yellow, blue, gray

[www.wago.com/769-107/000-039](http://www.wago.com/769-107/000-039)

**Item no.: 769-107/022-000**  
1-conductor female plug; angled; 4 mm<sup>2</sup>; 7-pole; 4,00 mm<sup>2</sup>; gray















[www.wago.com/769-107/022-000](http://www.wago.com/769-107/022-000)



**Item no.: 769-108**  
1-conductor female plug; 4 mm<sup>2</sup>; 8-pole; 4,00 mm<sup>2</sup>; gray















[www.wago.com/769-108](http://www.wago.com/769-108)

Subject to changes. Please also observe the further product documentation!

	<b>Item no.: 769-108/000-006</b> 1-conductor female plug; 4 mm <sup>2</sup> ; 8-pole; 4,00 mm <sup>2</sup> ; blue	<a href="http://www.wago.com/769-108/000-006">www.wago.com/769-108/000-006</a>
	<b>Item no.: 769-108/000-036</b> 1-conductor female plug; 4 mm <sup>2</sup> ; 8-pole; 4,00 mm <sup>2</sup> ; gray, green-yellow	<a href="http://www.wago.com/769-108/000-036">www.wago.com/769-108/000-036</a>
	<b>Item no.: 769-108/000-037</b> 1-conductor female plug; 4 mm <sup>2</sup> ; 8-pole; 4,00 mm <sup>2</sup> ; green-yellow, gray	<a href="http://www.wago.com/769-108/000-037">www.wago.com/769-108/000-037</a>
	<b>Item no.: 769-108/000-038</b> 1-conductor female plug; 4 mm <sup>2</sup> ; 8-pole; 4,00 mm <sup>2</sup> ; gray, blue, green-yellow	<a href="http://www.wago.com/769-108/000-038">www.wago.com/769-108/000-038</a>
	<b>Item no.: 769-108/000-039</b> 1-conductor female plug; 4 mm <sup>2</sup> ; 8-pole; 4,00 mm <sup>2</sup> ; green-yellow, blue, gray	<a href="http://www.wago.com/769-108/000-039">www.wago.com/769-108/000-039</a>
	<b>Item no.: 769-108/022-000</b> 1-conductor female plug; angled; 4 mm <sup>2</sup> ; 8-pole; 4,00 mm <sup>2</sup> ; gray	<a href="http://www.wago.com/769-108/022-000">www.wago.com/769-108/022-000</a>
	<b>Item no.: 769-109</b> 1-conductor female plug; 4 mm <sup>2</sup> ; 9-pole; 4,00 mm <sup>2</sup> ; gray	<a href="http://www.wago.com/769-109">www.wago.com/769-109</a>
	<b>Item no.: 769-109/000-006</b> 1-conductor female plug; 4 mm <sup>2</sup> ; 9-pole; 4,00 mm <sup>2</sup> ; blue	<a href="http://www.wago.com/769-109/000-006">www.wago.com/769-109/000-006</a>
	<b>Item no.: 769-109/000-036</b> 1-conductor female plug; 4 mm <sup>2</sup> ; 9-pole; 4,00 mm <sup>2</sup> ; gray, green-yellow	<a href="http://www.wago.com/769-109/000-036">www.wago.com/769-109/000-036</a>
	<b>Item no.: 769-109/000-037</b> 1-conductor female plug; 4 mm <sup>2</sup> ; 9-pole; 4,00 mm <sup>2</sup> ; green-yellow, gray	<a href="http://www.wago.com/769-109/000-037">www.wago.com/769-109/000-037</a>
	<b>Item no.: 769-109/000-038</b> 1-conductor female plug; 4 mm <sup>2</sup> ; 9-pole; 4,00 mm <sup>2</sup> ; gray, blue, green-yellow	<a href="http://www.wago.com/769-109/000-038">www.wago.com/769-109/000-038</a>
	<b>Item no.: 769-109/000-039</b> 1-conductor female plug; 4 mm <sup>2</sup> ; 9-pole; 4,00 mm <sup>2</sup> ; green-yellow, blue, gray	<a href="http://www.wago.com/769-109/000-039">www.wago.com/769-109/000-039</a>
	<b>Item no.: 769-109/022-000</b> 1-conductor female plug; angled; 4 mm <sup>2</sup> ; 9-pole; 4,00 mm <sup>2</sup> ; gray	<a href="http://www.wago.com/769-109/022-000">www.wago.com/769-109/022-000</a>
	<b>Item no.: 769-110</b> 1-conductor female plug; 4 mm <sup>2</sup> ; 10-pole; 4,00 mm <sup>2</sup> ; gray	<a href="http://www.wago.com/769-110">www.wago.com/769-110</a>

Subject to changes. Please also observe the further product documentation!



	<p><b>Item no.: 769-110/000-006</b> 1-conductor female plug; 4 mm<sup>2</sup>; 10-pole; 4,00 mm<sup>2</sup>; blue</p>	<a href="http://www.wago.com/769-110/000-006">www.wago.com/769-110/000-006</a>
	<p><b>Item no.: 769-110/000-036</b> 1-conductor female plug; 4 mm<sup>2</sup>; 10-pole; 4,00 mm<sup>2</sup>; gray, green-yellow</p>	<a href="http://www.wago.com/769-110/000-036">www.wago.com/769-110/000-036</a>
	<p><b>Item no.: 769-110/000-037</b> 1-conductor female plug; 4 mm<sup>2</sup>; 10-pole; 4,00 mm<sup>2</sup>; green-yellow, gray</p>	<a href="http://www.wago.com/769-110/000-037">www.wago.com/769-110/000-037</a>
	<p><b>Item no.: 769-110/000-038</b> 1-conductor female plug; 4 mm<sup>2</sup>; 10-pole; 4,00 mm<sup>2</sup>; gray, blue, green-yellow</p>	<a href="http://www.wago.com/769-110/000-038">www.wago.com/769-110/000-038</a>
	<p><b>Item no.: 769-110/000-039</b> 1-conductor female plug; 4 mm<sup>2</sup>; 10-pole; 4,00 mm<sup>2</sup>; green-yellow, blue, gray</p>	<a href="http://www.wago.com/769-110/000-039">www.wago.com/769-110/000-039</a>
	<p><b>Item no.: 769-110/022-000</b> 1-conductor female plug; angled; 4 mm<sup>2</sup>; 10-pole; 4,00 mm<sup>2</sup>; gray</p>	<a href="http://www.wago.com/769-110/022-000">www.wago.com/769-110/022-000</a>
	<p><b>Item no.: 769-111</b> 1-conductor female plug; 4 mm<sup>2</sup>; 11-pole; 4,00 mm<sup>2</sup>; gray</p>	<a href="http://www.wago.com/769-111">www.wago.com/769-111</a>
	<p><b>Item no.: 769-111/000-006</b> 1-conductor female plug; 4 mm<sup>2</sup>; 11-pole; 4,00 mm<sup>2</sup>; blue</p>	<a href="http://www.wago.com/769-111/000-006">www.wago.com/769-111/000-006</a>
	<p><b>Item no.: 769-111/000-036</b> 1-conductor female plug; 4 mm<sup>2</sup>; 11-pole; 4,00 mm<sup>2</sup>; gray, green-yellow</p>	<a href="http://www.wago.com/769-111/000-036">www.wago.com/769-111/000-036</a>
	<p><b>Item no.: 769-111/000-037</b> 1-conductor female plug; 4 mm<sup>2</sup>; 11-pole; 4,00 mm<sup>2</sup>; green-yellow, gray</p>	<a href="http://www.wago.com/769-111/000-037">www.wago.com/769-111/000-037</a>
	<p><b>Item no.: 769-111/000-038</b> 1-conductor female plug; 4 mm<sup>2</sup>; 11-pole; 4,00 mm<sup>2</sup>; gray, blue, green-yellow</p>	<a href="http://www.wago.com/769-111/000-038">www.wago.com/769-111/000-038</a>
	<p><b>Item no.: 769-111/000-039</b> 1-conductor female plug; 4 mm<sup>2</sup>; 11-pole; 4,00 mm<sup>2</sup>; green-yellow, blue, gray</p>	<a href="http://www.wago.com/769-111/000-039">www.wago.com/769-111/000-039</a>
	<p><b>Item no.: 769-111/022-000</b> 1-conductor female plug; angled; 4 mm<sup>2</sup>; 11-pole; 4,00 mm<sup>2</sup>; gray</p>	<a href="http://www.wago.com/769-111/022-000">www.wago.com/769-111/022-000</a>
	<p><b>Item no.: 769-112</b> 1-conductor female plug; 4 mm<sup>2</sup>; 12-pole; 4,00 mm<sup>2</sup>; gray</p>	<a href="http://www.wago.com/769-112">www.wago.com/769-112</a>

Subject to changes. Please also observe the further product documentation!



**Item no.: 769-112/000-006**  
1-conductor female plug; 4 mm<sup>2</sup>; 12-pole; 4,00 mm<sup>2</sup>; blue

[www.wago.com/769-112/000-006](http://www.wago.com/769-112/000-006)



**Item no.: 769-112/000-036**  
1-conductor female plug; 4 mm<sup>2</sup>; 12-pole; 4,00 mm<sup>2</sup>; gray, green-yellow

[www.wago.com/769-112/000-036](http://www.wago.com/769-112/000-036)



**Item no.: 769-112/000-037**  
1-conductor female plug; 4 mm<sup>2</sup>; 12-pole; 4,00 mm<sup>2</sup>; green-yellow, gray

[www.wago.com/769-112/000-037](http://www.wago.com/769-112/000-037)



**Item no.: 769-112/000-038**  
1-conductor female plug; 4 mm<sup>2</sup>; 12-pole; 4,00 mm<sup>2</sup>; gray, blue, green-yellow

[www.wago.com/769-112/000-038](http://www.wago.com/769-112/000-038)



**Item no.: 769-112/000-039**  
1-conductor female plug; 4 mm<sup>2</sup>; 12-pole; 4,00 mm<sup>2</sup>; green-yellow, blue, gray

[www.wago.com/769-112/000-039](http://www.wago.com/769-112/000-039)



**Item no.: 769-112/022-000**  
1-conductor female plug; angled; 4 mm<sup>2</sup>; 12-pole; 4,00 mm<sup>2</sup>; gray

[www.wago.com/769-112/022-000](http://www.wago.com/769-112/022-000)



**Item no.: 769-113**  
1-conductor female plug; 4 mm<sup>2</sup>; 13-pole; 4,00 mm<sup>2</sup>; gray

[www.wago.com/769-113](http://www.wago.com/769-113)



**Item no.: 769-113/000-036**  
1-conductor female plug; 4 mm<sup>2</sup>; 13-pole; 4,00 mm<sup>2</sup>; gray, green-yellow

[www.wago.com/769-113/000-036](http://www.wago.com/769-113/000-036)



**Item no.: 769-113/000-037**  
1-conductor female plug; 4 mm<sup>2</sup>; 13-pole; 4,00 mm<sup>2</sup>; green-yellow, gray

[www.wago.com/769-113/000-037](http://www.wago.com/769-113/000-037)



**Item no.: 769-113/000-038**  
1-conductor female plug; 4 mm<sup>2</sup>; 13-pole; 4,00 mm<sup>2</sup>; gray, blue, green-yellow

[www.wago.com/769-113/000-038](http://www.wago.com/769-113/000-038)



**Item no.: 769-113/000-039**  
1-conductor female plug; 4 mm<sup>2</sup>; 13-pole; 4,00 mm<sup>2</sup>; green-yellow, blue, gray

[www.wago.com/769-113/000-039](http://www.wago.com/769-113/000-039)



**Item no.: 769-113/022-000**  
1-conductor female plug; angled; 4 mm<sup>2</sup>; 13-pole; 4,00 mm<sup>2</sup>; gray

[www.wago.com/769-113/022-000](http://www.wago.com/769-113/022-000)



**Item no.: 769-114**  
1-conductor female plug; 4 mm<sup>2</sup>; 14-pole; 4,00 mm<sup>2</sup>; gray

[www.wago.com/769-114](http://www.wago.com/769-114)



**Item no.: 769-114/000-006**  
1-conductor female plug; 4 mm<sup>2</sup>; 14-pole; 4,00 mm<sup>2</sup>; blue

[www.wago.com/769-114/000-006](http://www.wago.com/769-114/000-006)

Subject to changes. Please also observe the further product documentation!



**Item no.: 769-114/000-036**  
1-conductor female plug; 4 mm<sup>2</sup>; 14-pole; 4,00 mm<sup>2</sup>; gray, green-yellow

[www.wago.com/769-114/000-036](http://www.wago.com/769-114/000-036)



**Item no.: 769-114/000-037**  
1-conductor female plug; 4 mm<sup>2</sup>; 14-pole; 4,00 mm<sup>2</sup>; green-yellow, gray

[www.wago.com/769-114/000-037](http://www.wago.com/769-114/000-037)



**Item no.: 769-114/000-038**  
1-conductor female plug; 4 mm<sup>2</sup>; 14-pole; 4,00 mm<sup>2</sup>; gray, blue, green-yellow

[www.wago.com/769-114/000-038](http://www.wago.com/769-114/000-038)



**Item no.: 769-114/000-039**  
1-conductor female plug; 4 mm<sup>2</sup>; 14-pole; 4,00 mm<sup>2</sup>; green-yellow, blue, gray

[www.wago.com/769-114/000-039](http://www.wago.com/769-114/000-039)



**Item no.: 769-114/022-000**  
1-conductor female plug; angled; 4 mm<sup>2</sup>; 14-pole; 4,00 mm<sup>2</sup>; gray

[www.wago.com/769-114/022-000](http://www.wago.com/769-114/022-000)



**Item no.: 769-115**  
1-conductor female plug; 4 mm<sup>2</sup>; 15-pole; 4,00 mm<sup>2</sup>; gray

[www.wago.com/769-115](http://www.wago.com/769-115)



**Item no.: 769-115/000-036**  
1-conductor female plug; 4 mm<sup>2</sup>; 15-pole; 4,00 mm<sup>2</sup>; gray, green-yellow

[www.wago.com/769-115/000-036](http://www.wago.com/769-115/000-036)



**Item no.: 769-115/000-037**  
1-conductor female plug; 4 mm<sup>2</sup>; 15-pole; 4,00 mm<sup>2</sup>; green-yellow, gray

[www.wago.com/769-115/000-037](http://www.wago.com/769-115/000-037)



**Item no.: 769-115/000-038**  
1-conductor female plug; 4 mm<sup>2</sup>; 15-pole; 4,00 mm<sup>2</sup>; gray, blue, green-yellow

[www.wago.com/769-115/000-038](http://www.wago.com/769-115/000-038)



**Item no.: 769-115/000-039**  
1-conductor female plug; 4 mm<sup>2</sup>; 15-pole; 4,00 mm<sup>2</sup>; green-yellow, blue, gray

[www.wago.com/769-115/000-039](http://www.wago.com/769-115/000-039)



**Item no.: 769-115/022-000**  
1-conductor female plug; angled; 4 mm<sup>2</sup>; 15-pole; 4,00 mm<sup>2</sup>; gray

[www.wago.com/769-115/022-000](http://www.wago.com/769-115/022-000)



**Item no.: 769-121**  
2-conductor female connector; 4 mm<sup>2</sup>; 1-pole; 4,00 mm<sup>2</sup>; gray

[www.wago.com/769-121](http://www.wago.com/769-121)



**Item no.: 769-121/000-016**  
2-conductor female connector; 4 mm<sup>2</sup>; 1-pole; 4,00 mm<sup>2</sup>; green-yellow

















[www.wago.com/769-121/000-016](http://www.wago.com/769-121/000-016)

















**Item no.: 769-122**  
2-conductor female connector; 4 mm<sup>2</sup>; 2-pole; 4,00 mm<sup>2</sup>; gray

[www.wago.com/769-122](http://www.wago.com/769-122)













Subject to changes. Please also observe the further product documentation!

	<b>Item no.: 769-123</b> 2-conductor female connector; 4 mm <sup>2</sup> ; 3-pole; 4,00 mm <sup>2</sup> ; gray	<a href="http://www.wago.com/769-123">www.wago.com/769-123</a>
	<b>Item no.: 769-124</b> 2-conductor female connector; 4 mm <sup>2</sup> ; 4-pole; 4,00 mm <sup>2</sup> ; gray	<a href="http://www.wago.com/769-124">www.wago.com/769-124</a>
	<b>Item no.: 769-125</b> 2-conductor female connector; 4 mm <sup>2</sup> ; 5-pole; 4,00 mm <sup>2</sup> ; gray	<a href="http://www.wago.com/769-125">www.wago.com/769-125</a>
	<b>Item no.: 769-126</b> 2-conductor female connector; 4 mm <sup>2</sup> ; 6-pole; 4,00 mm <sup>2</sup> ; gray	<a href="http://www.wago.com/769-126">www.wago.com/769-126</a>
	<b>Item no.: 769-127</b> 2-conductor female connector; 4 mm <sup>2</sup> ; 7-pole; 4,00 mm <sup>2</sup> ; gray	<a href="http://www.wago.com/769-127">www.wago.com/769-127</a>
	<b>Item no.: 769-128</b> 2-conductor female connector; 4 mm <sup>2</sup> ; 8-pole; 4,00 mm <sup>2</sup> ; gray	<a href="http://www.wago.com/769-128">www.wago.com/769-128</a>
	<b>Item no.: 769-129</b> 2-conductor female connector; 4 mm <sup>2</sup> ; 9-pole; 4,00 mm <sup>2</sup> ; gray	<a href="http://www.wago.com/769-129">www.wago.com/769-129</a>
	<b>Item no.: 769-130</b> 2-conductor female connector; 4 mm <sup>2</sup> ; 10-pole; 4,00 mm <sup>2</sup> ; gray	<a href="http://www.wago.com/769-130">www.wago.com/769-130</a>
	<b>Item no.: 769-131</b> 2-conductor female connector; 4 mm <sup>2</sup> ; 11-pole; 4,00 mm <sup>2</sup> ; gray	<a href="http://www.wago.com/769-131">www.wago.com/769-131</a>
	<b>Item no.: 769-132</b> 2-conductor female connector; 4 mm <sup>2</sup> ; 12-pole; 4,00 mm <sup>2</sup> ; gray	<a href="http://www.wago.com/769-132">www.wago.com/769-132</a>
	<b>Item no.: 769-133</b> 2-conductor female connector; 4 mm <sup>2</sup> ; 13-pole; 4,00 mm <sup>2</sup> ; gray	<a href="http://www.wago.com/769-133">www.wago.com/769-133</a>
	<b>Item no.: 769-134</b> 2-conductor female connector; 4 mm <sup>2</sup> ; 14-pole; 4,00 mm <sup>2</sup> ; gray	<a href="http://www.wago.com/769-134">www.wago.com/769-134</a>
	<b>Item no.: 769-135</b> 2-conductor female connector; 4 mm <sup>2</sup> ; 15-pole; 4,00 mm <sup>2</sup> ; gray	<a href="http://www.wago.com/769-135">www.wago.com/769-135</a>
<b>General accessories</b>		
	<b>Item no.: 769-438</b> Pin cover; with marker slot for miniature WSB; gray	<a href="http://www.wago.com/769-438">www.wago.com/769-438</a>
	<b>Item no.: 769-439</b> Pin cover; with marker slot for miniature WSB; orange	<a href="http://www.wago.com/769-439">www.wago.com/769-439</a>
	<b>Item no.: 769-501</b> Start module for 1-conductor female connector; with integrated end plate; 4 mm <sup>2</sup> ; 1-pole; 4,00 mm <sup>2</sup> ; gray	<a href="http://www.wago.com/769-501">www.wago.com/769-501</a>
	<b>Item no.: 769-501/000-006</b> Start module for 1-conductor female connector; 4 mm <sup>2</sup> ; 1-pole; 4,00 mm <sup>2</sup> ; blue	<a href="http://www.wago.com/769-501/000-006">www.wago.com/769-501/000-006</a>
	<b>Item no.: 769-501/000-016</b>	

Subject to changes. Please also observe the further product documentation!

	Start module for 1-conductor female connector; with integrated end plate; 4 mm <sup>2</sup> ; 1-pole; 4,00 mm <sup>2</sup> ; green-yellow	<a href="http://www.wago.com/769-501/000-016">www.wago.com/769-501/000-016</a>
	<b>Item no.: 769-502</b> Center module for 1-conductor female connector; 4 mm <sup>2</sup> ; 1-pole; 4,00 mm <sup>2</sup> ; gray	<a href="http://www.wago.com/769-502">www.wago.com/769-502</a>
	<b>Item no.: 769-502/000-006</b> Center module for 1-conductor female connector; 4 mm <sup>2</sup> ; 1-pole; 4,00 mm <sup>2</sup> ; blue	<a href="http://www.wago.com/769-502/000-006">www.wago.com/769-502/000-006</a>
	<b>Item no.: 769-502/000-016</b> Center module for 1-conductor female connector; 4 mm <sup>2</sup> ; 1-pole; 4,00 mm <sup>2</sup> ; green-yellow	<a href="http://www.wago.com/769-502/000-016">www.wago.com/769-502/000-016</a>
	<b>Item no.: 769-503</b> End module for 1-conductor female connector; 4 mm <sup>2</sup> ; 1-pole; 4,00 mm <sup>2</sup> ; gray	<a href="http://www.wago.com/769-503">www.wago.com/769-503</a>
	<b>Item no.: 769-503/000-006</b> End module for 1-conductor female connector; 4 mm <sup>2</sup> ; 1-pole; 4,00 mm <sup>2</sup> ; blue	<a href="http://www.wago.com/769-503/000-006">www.wago.com/769-503/000-006</a>
	<b>Item no.: 769-503/000-016</b> End module for 1-conductor female connector; 4 mm <sup>2</sup> ; 1-pole; 4,00 mm <sup>2</sup> ; green-yellow	<a href="http://www.wago.com/769-503/000-016">www.wago.com/769-503/000-016</a>
	<b>Item no.: 769-504</b> Start module for 2-conductor female connector; with integrated end plate; 4 mm <sup>2</sup> ; 1-pole; 4,00 mm <sup>2</sup> ; gray	<a href="http://www.wago.com/769-504">www.wago.com/769-504</a>
	<b>Item no.: 769-504/000-006</b> Start module for 2-conductor female connector; with integrated end plate; 4 mm <sup>2</sup> ; 1-pole; 4,00 mm <sup>2</sup> ; blue	<a href="http://www.wago.com/769-504/000-006">www.wago.com/769-504/000-006</a>
	<b>Item no.: 769-504/000-016</b> Start module for 2-conductor female connector; 4 mm <sup>2</sup> ; 1-pole; 4,00 mm <sup>2</sup> ; green-yellow	<a href="http://www.wago.com/769-504/000-016">www.wago.com/769-504/000-016</a>
	<b>Item no.: 769-505</b> Center module for 2-conductor female connector; 4 mm <sup>2</sup> ; 1-pole; 4,00 mm <sup>2</sup> ; gray	<a href="http://www.wago.com/769-505">www.wago.com/769-505</a>
	<b>Item no.: 769-505/000-006</b> Center module for 2-conductor female connector; 4 mm <sup>2</sup> ; 1-pole; 4,00 mm <sup>2</sup> ; blue	<a href="http://www.wago.com/769-505/000-006">www.wago.com/769-505/000-006</a>
	<b>Item no.: 769-505/000-016</b> Center module for 2-conductor female connector; 4 mm <sup>2</sup> ; 1-pole; 4,00 mm <sup>2</sup> ; green-yellow	<a href="http://www.wago.com/769-505/000-016">www.wago.com/769-505/000-016</a>
	<b>Item no.: 769-506</b> End module for 2-conductor female connector; 4 mm <sup>2</sup> ; 1-pole; 4,00 mm <sup>2</sup> ; gray	<a href="http://www.wago.com/769-506">www.wago.com/769-506</a>
	<b>Item no.: 769-506/000-006</b> End module for 2-conductor female connector; 4 mm <sup>2</sup> ; 1-pole; 4,00 mm <sup>2</sup> ; blue	<a href="http://www.wago.com/769-506/000-006">www.wago.com/769-506/000-006</a>

Subject to changes. Please also observe the further product documentation!

	<b>Item no.: 769-506/000-016</b> End module for 2-conductor female connector; 4 mm <sup>2</sup> ; 1-pole; 4,00 mm <sup>2</sup> ; green-yellow	<a href="http://www.wago.com/769-506/000-016">www.wago.com/769-506/000-016</a>
	<b>Item no.: 769-512</b> Start module for 1-conductor female connector; angled; 4 mm <sup>2</sup> ; 1-pole; 4,00 mm <sup>2</sup> ; gray	<a href="http://www.wago.com/769-512">www.wago.com/769-512</a>
	<b>Item no.: 769-512/000-006</b> Start module for 1-conductor female connector; angled; 4 mm <sup>2</sup> ; 1-pole; 4,00 mm <sup>2</sup> ; blue	<a href="http://www.wago.com/769-512/000-006">www.wago.com/769-512/000-006</a>
	<b>Item no.: 769-512/000-016</b> Start module for 1-conductor female connector; angled; 4 mm <sup>2</sup> ; 1-pole; 4,00 mm <sup>2</sup> ; green-yellow	<a href="http://www.wago.com/769-512/000-016">www.wago.com/769-512/000-016</a>
	<b>Item no.: 769-513</b> Center module for 1-conductor female connector; angled; 4 mm <sup>2</sup> ; 1-pole; 4,00 mm <sup>2</sup> ; gray	<a href="http://www.wago.com/769-513">www.wago.com/769-513</a>
	<b>Item no.: 769-513/000-006</b> Center module for 1-conductor female connector; angled; 4 mm <sup>2</sup> ; 1-pole; 4,00 mm <sup>2</sup> ; blue	<a href="http://www.wago.com/769-513/000-006">www.wago.com/769-513/000-006</a>
	<b>Item no.: 769-513/000-016</b> Center module for 1-conductor female connector; angled; 4 mm <sup>2</sup> ; 1-pole; 4,00 mm <sup>2</sup> ; green-yellow	<a href="http://www.wago.com/769-513/000-016">www.wago.com/769-513/000-016</a>
	<b>Item no.: 769-515</b> End module for 1-conductor female connector; angled; 4 mm <sup>2</sup> ; 1-pole; 4,00 mm <sup>2</sup> ; gray	<a href="http://www.wago.com/769-515">www.wago.com/769-515</a>
	<b>Item no.: 769-515/000-006</b> End module for 1-conductor female connector; angled; 4 mm <sup>2</sup> ; 1-pole; 4,00 mm <sup>2</sup> ; blue	<a href="http://www.wago.com/769-515/000-006">www.wago.com/769-515/000-006</a>
	<b>Item no.: 769-515/000-016</b> End module for 1-conductor female connector; angled; 4 mm <sup>2</sup> ; 1-pole; 4,00 mm <sup>2</sup> ; green-yellow	<a href="http://www.wago.com/769-515/000-016">www.wago.com/769-515/000-016</a>
<b>Jumper</b>		
	<b>Item no.: 249-123</b> Push-in type wire jumper; insulated; wire length 180 mm; Conductor cross section 0.75 mm <sup>2</sup>	<a href="http://www.wago.com/249-123">www.wago.com/249-123</a>
	<b>Item no.: 249-125</b> Push-in type wire jumper; insulated; wire length 60 mm; Conductor cross section 0.75 mm <sup>2</sup>	<a href="http://www.wago.com/249-125">www.wago.com/249-125</a>
	<b>Item no.: 249-126</b> Push-in type wire jumper; insulated; wire length 110 mm; Conductor cross section 0.75 mm <sup>2</sup>	<a href="http://www.wago.com/249-126">www.wago.com/249-126</a>
	<b>Item no.: 249-127</b> Push-in type wire jumper; insulated; wire length 250 mm; Conductor cross section 0.75 mm <sup>2</sup>	<a href="http://www.wago.com/249-127">www.wago.com/249-127</a>
<b>Test Accessories</b>		

Subject to changes. Please also observe the further product documentation!

**Item no.: 210-136**

Test plug; 2 mm Ø; with 500 mm cable; red

[www.wago.com/210-136](http://www.wago.com/210-136)



**Item no.: 210-137**

Test plug; 2.3 mm Ø; with 500 mm cable; yellow

[www.wago.com/210-137](http://www.wago.com/210-137)

**Item no.: 280-418**

Test plug module; modular; suitable for all WAGO 280 and 780 Series rail-mounted terminal blocks with jumper slots in the current bar; gray [www.wago.com/280-418](http://www.wago.com/280-418)

**Item no.: 280-419**

Spacer module; modular; bridging commoned terminal blocks; gray

[www.wago.com/280-419](http://www.wago.com/280-419)

**Marking accessories**

**Item no.: 2009-145**

Mini-WSB Inline; for Smart Printer; 1700 pieces on roll; stretchable 5 - 5.2 mm; plain; snap-on type; white [www.wago.com/2009-145](http://www.wago.com/2009-145)

**Item no.: 2009-145/000-002**

Mini-WSB Inline; for Smart Printer; 1700 pieces on roll; stretchable 5 - 5.2 mm; plain; snap-on type; white /000-002 [www.wago.com/2009-145](http://www.wago.com/2009-145)



**Item no.: 2009-145/000-005**

Mini-WSB Inline; for Smart Printer; 1700 pieces on roll; stretchable 5 - 5.2 mm; plain; snap-on type; red [www.wago.com/2009-145](http://www.wago.com/2009-145)



**Item no.: 2009-145/000-006**

Mini-WSB Inline; for Smart Printer; 1700 pieces on roll; stretchable 5 - 5.2 mm; plain; snap-on type; blue [www.wago.com/2009-145](http://www.wago.com/2009-145)



**Item no.: 2009-145/000-007**

Mini-WSB Inline; for Smart Printer; 1700 pieces on roll; stretchable 5 - 5.2 mm; plain; snap-on type; white [www.wago.com/2009-145](http://www.wago.com/2009-145)



**Item no.: 2009-145/000-012**

Mini-WSB Inline; for Smart Printer; 1700 pieces on roll; stretchable 5 - 5.2 mm; plain; snap-on type; orange [www.wago.com/2009-145](http://www.wago.com/2009-145)



**Item no.: 2009-145/000-023**

Mini-WSB Inline; for Smart Printer; 1700 pieces on roll; stretchable 5 - 5.2 mm; plain; snap-on type; green [www.wago.com/2009-145](http://www.wago.com/2009-145)

**Item no.: 2009-145/000-024**

Mini-WSB Inline; for Smart Printer; 1700 pieces on roll; stretchable 5 - 5.2 mm; plain; snap-on type; violet [www.wago.com/2009-145](http://www.wago.com/2009-145)



**Item no.: 248-501**

Miniature WSB Quick marking system; plain; Marker width 5 mm; 10 strips with 10 markers per card [www.wago.com/248-501](http://www.wago.com/248-501)

**Item no.: 248-501/000-002**

Mini-WSB marking card; as card; not stretchable; plain; snap-on type; yellow [www.wago.com/248-501](http://www.wago.com/248-501)

Subject to changes. Please also observe the further product documentation!

WAGO Kontakttechnik GmbH & Co. KG

Hansastr. 27

32423 Minden

Phone: +49571 887-0 | Fax: +49571 887-169

Email: [info.de@wago.com](mailto:info.de@wago.com) | Web: [www.wago.com](http://www.wago.com)

Do you have any questions about our products?

We are always happy to take your call at +49 (571) 887-44222.



**Item no.: 248-501/000-005**  
Mini-WSB marking card; as card; not stretchable; plain; snap-on type; red

[www.wago.com/248-501/000-005](http://www.wago.com/248-501/000-005)



**Item no.: 248-501/000-006**  
Mini-WSB marking card; as card; not stretchable; plain; snap-on type; blue

[www.wago.com/248-501/000-006](http://www.wago.com/248-501/000-006)

**Item no.: 248-501/000-007**  
Mini-WSB marking card; as card; not stretchable; plain; snap-on type; gray

[www.wago.com/248-501/000-007](http://www.wago.com/248-501/000-007)

**Item no.: 248-501/000-012**  
Mini-WSB marking card; as card; not stretchable; plain; snap-on type; orange

[www.wago.com/248-501/000-012](http://www.wago.com/248-501/000-012)



**Item no.: 248-501/000-017**  
Mini-WSB marking card; as card; not stretchable; plain; snap-on type; light green

[www.wago.com/248-501/000-017](http://www.wago.com/248-501/000-017)



**Item no.: 248-501/000-023**  
Mini-WSB marking card; as card; not stretchable; plain; snap-on type; green

[www.wago.com/248-501/000-023](http://www.wago.com/248-501/000-023)

**Item no.: 248-501/000-024**  
Mini-WSB marking card; as card; not stretchable; plain; snap-on type; violet

[www.wago.com/248-501/000-024](http://www.wago.com/248-501/000-024)

#### assembling



**Item no.: 209-106**  
Mounting carrier; for isolated mounting on DIN 35 rails; gray

[www.wago.com/209-106](http://www.wago.com/209-106)

#### tools



**Item no.: 210-720**  
Operating tool; Blade: 3.5 x 0.5 mm; with a partially insulated shaft

[www.wago.com/210-720](http://www.wago.com/210-720)

#### Carrier rail



**Item no.: 210-112**  
Steel carrier rail; 35 x 7.5 mm; 1 mm thick; 2 m long; slotted; according to EN 60715; "Hole width 25 mm

[www.wago.com/210-112](http://www.wago.com/210-112)

**Item no.: 210-113**  
Steel carrier rail; 35 x 7.5 mm; 1 mm thick; 2 m long; unslotted; according to EN 60715

[www.wago.com/210-113](http://www.wago.com/210-113)

**Item no.: 210-114**  
Steel carrier rail; 35 x 15 mm; 1.5 mm thick; 2 m long; unslotted; similar to EN 60715

[www.wago.com/210-114](http://www.wago.com/210-114)

**Item no.: 210-115**  
Steel carrier rail; 35 x 7.5 mm; 1 mm thick; 2 m long; slotted; according to EN 60715; "Hole width 18 mm







[www.wago.com/210-115](http://www.wago.com/210-115)

**Item no.: 210-118**  
Steel carrier rail; 35 x 15 mm; 2.3 mm thick; 2 m long; unslotted; according to EN 60715

[www.wago.com/210-118](http://www.wago.com/210-118)

Subject to changes. Please also observe the further product documentation!



	<b>Item no.: 210-196</b> Aluminum carrier rail; 35 x 8.2 mm; 1.6 mm thick; 2 m long; unslotted; similar to EN 60715; silver-colored	<a href="http://www.wago.com/210-196">www.wago.com/210-196</a>
	<b>Item no.: 210-197</b> Steel carrier rail; 35 x 15 mm; 1.5 mm thick; 2 m long; slotted; similar to EN 60715	<a href="http://www.wago.com/210-197">www.wago.com/210-197</a>
	<b>Item no.: 210-198</b> Copper carrier rail; 35 x 15 mm; 2.3 mm thick; 2 m long; unslotted; according to EN 60715; copper-colored	<a href="http://www.wago.com/210-198">www.wago.com/210-198</a>
	<b>Item no.: 210-504</b> Steel carrier rail; 35 x 7.5 mm; 1 mm thick; 2 m long; slotted; galvanized; according to EN 60715	<a href="http://www.wago.com/210-504">www.wago.com/210-504</a>
	<b>Item no.: 210-505</b> Steel carrier rail; 35 x 7.5 mm; 1 mm thick; 2 m long; unslotted; galvanized; according to EN 60715	<a href="http://www.wago.com/210-505">www.wago.com/210-505</a>
	<b>Item no.: 210-506</b> Steel carrier rail; 35 x 15 mm; 1.5 mm thick; 2 m long; unslotted; galvanized; similar to EN 60715	<a href="http://www.wago.com/210-506">www.wago.com/210-506</a>
	<b>Item no.: 210-508</b> Steel carrier rail; 35 x 15 mm; 1.5 mm thick; 2 m long; slotted; galvanized; similar to EN 60715	<a href="http://www.wago.com/210-508">www.wago.com/210-508</a>
<b>Coding</b>		
	<b>Item no.: 769-435</b> Coding pin; for coding of female plugs; for carrier terminal blocks / male connectors; orange	<a href="http://www.wago.com/769-435">www.wago.com/769-435</a>
<b>Insulation stop</b>		
	<b>Item no.: 769-470</b> Insulation stop; 0.08 - 0.2 mm <sup>2</sup> "s" (0.14 mm <sup>2</sup> "f-st"); 5 pieces/strip; white	<a href="http://www.wago.com/769-470">www.wago.com/769-470</a>
	<b>Item no.: 769-471</b> Insulation stop; 0.25 - 0.5 mm <sup>2</sup> ; 5 pieces/strip; light gray	<a href="http://www.wago.com/769-471">www.wago.com/769-471</a>
	<b>Item no.: 769-472</b> Insulation stop; 0.75 - 1 mm <sup>2</sup> ; 5 pieces/strip; dark gray	<a href="http://www.wago.com/769-472">www.wago.com/769-472</a>

## Downloads

### Documentation

#### Additional Information

Technical explanations	Apr 3, 2019	pdf 2.1 MB	Download
------------------------	-------------	---------------	----------

## CAD/CAE-Data

### CAD data

2D/3D Models 769-238/281-410	URL	Download
------------------------------	-----	----------

### CAE data

Subject to changes. Please also observe the further product documentation!

EPLAN Data Portal 769-238/281-410

URL

Download

WSCAD Universe 769-238/281-410

URL

Download

## Installation Notes

### Assembly

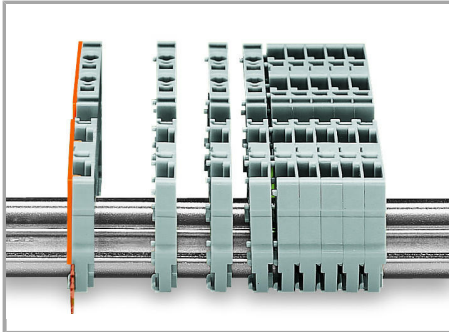

Snap individual carrier terminal blocks onto the carrier rail and slide together.

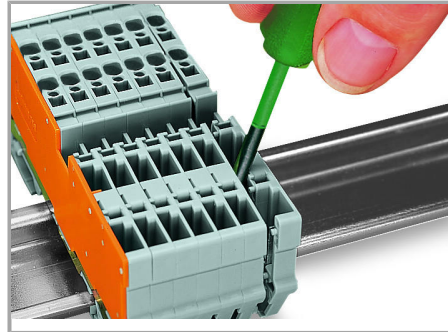

Open the assembly by laterally sliding a block via operating tool and remove terminal block via release lever.

### Inserting a conductor

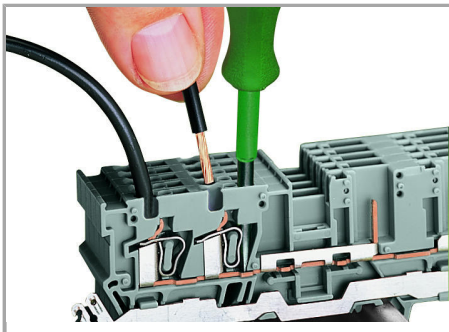

### CAGE CLAMP® connection

Carrier terminal block: Insert/remove conductor via operating tool (3.5 x 0.5 mm blade).

### Jumpered

Subject to changes. Please also observe the further product documentation!

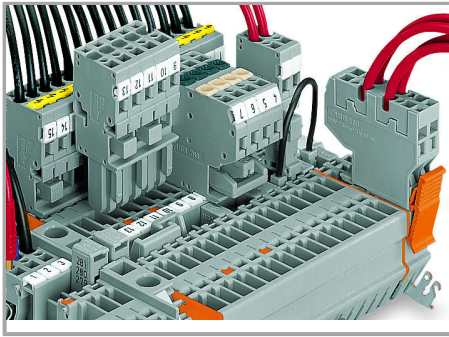

Commoning with adjacent or staggered jumpers –

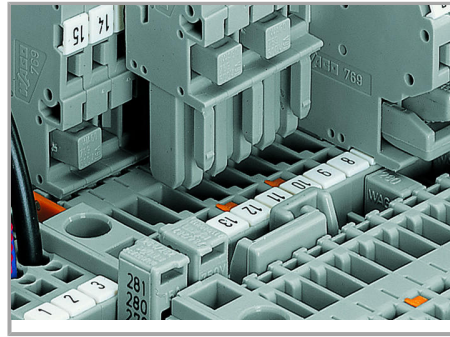

Commoning carrier terminal blocks via staggered jumpers.

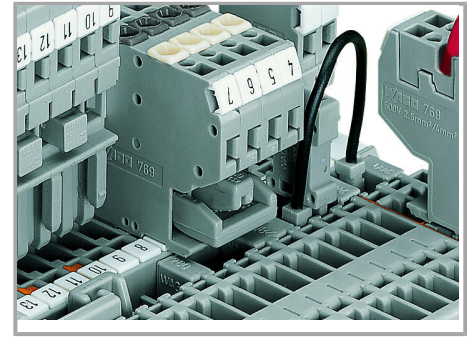

Commoning a 2-conductor female plug via staggered jumper and carrier terminal blocks via adjacent jumpers.

push jumpers down until fully inserted.

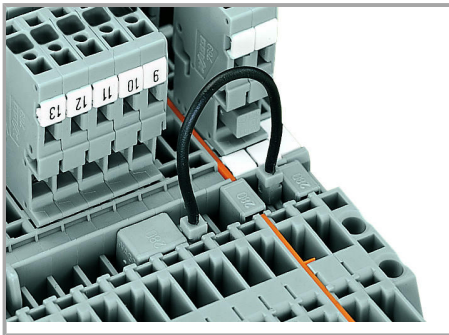

Commoning carrier terminal blocks via push-in type wire jumpers or adjacent jumpers – even over an intermediate plate.

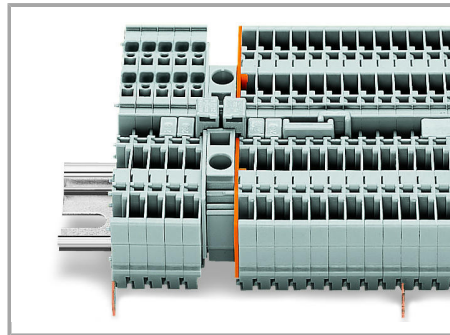

Commoning "supply terminal blocks" (up to 10 mm<sup>2</sup>/8 AWG) with carrier terminal blocks via step-down jumpers.

### Testing

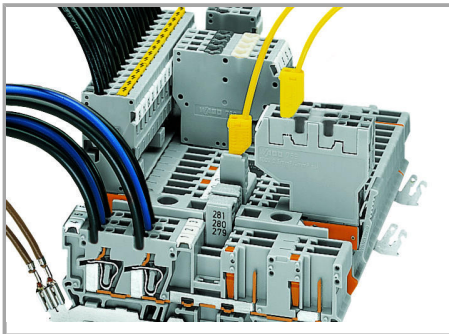

Testing via 2 or 2.3 mm Ø test plugs.

Subject to changes. Please also observe the further product documentation!

### Coding

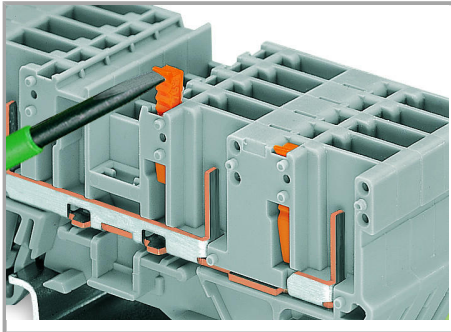

Snap coding pin in proper direction on carrier terminal block.

Shown: Coding pin removal from carrier terminal block.

### Locking

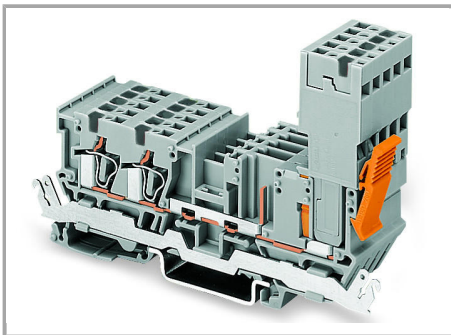

Female plug secured with locking lever on the terminal block side.

Subject to changes. Please also observe the further product documentation!

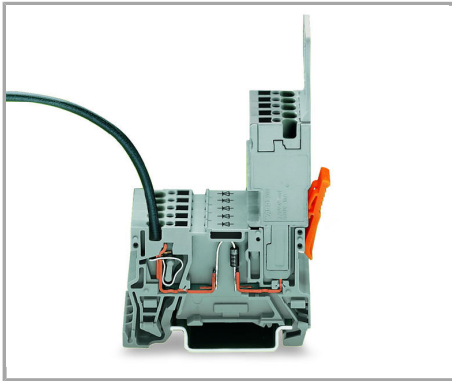

1-conductor female plug

Diode carrier terminal blocks cannot be commoned.

## Product family

### X-COM

[Learn more about the product family.](#)

[Show all products from the family](#)

Subject to changes. Please also observe the further product documentation!