

Data sheet | Item number: 769-237

1-conductor/1-pin ground carrier terminal block; for DIN-rail 35 x 15 and 35 x 7.5; 4 mm<sup>2</sup>; CAGE CLAMP®; 4,00 mm<sup>2</sup>; green-yellow

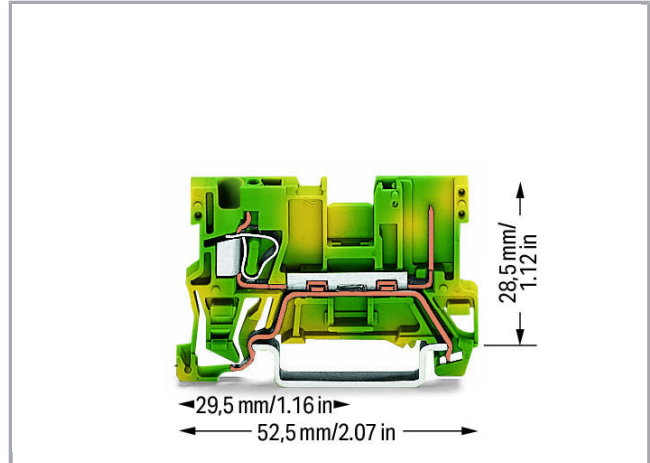

[www.wago.com/769-237](http://www.wago.com/769-237)



RoHS  
Compliant ✓

BOMcheck.net

Color:

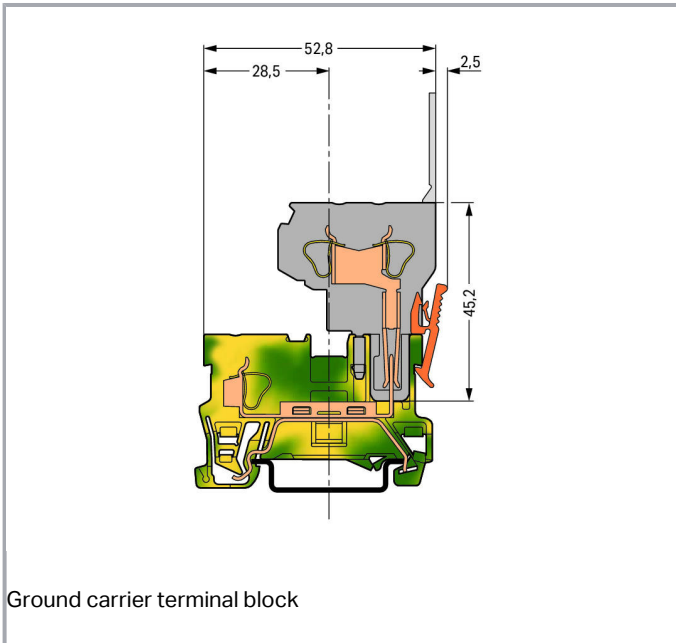

Subject to changes. Please also observe the further product documentation!

WAGO Kontakttechnik GmbH & Co. KG  
Hansastr. 27  
32423 Minden  
Phone: +49571 887-0 | Fax: +49571 887-169  
Email: [info.de@wago.com](mailto:info.de@wago.com) | Web: [www.wago.com](http://www.wago.com)

Do you have any questions about our products?  
We are always happy to take your call at +49 (571) 887-44222.



## Data

### Electrical data

#### Ratings per IEC/EN 60664-1

Ratings per	IEC/EN 60947-7-2
-------------	------------------

#### Connection data

Connection technology	CAGE CLAMP®
Actuation type	Open Tool Slot
Connectable conductor materials	Copper
Nominal cross section	4 mm <sup>2</sup>
Solid conductor	0,08 ... 4 mm <sup>2</sup> / 28 ... 12 AWG
Fine-stranded conductor	0,08 ... 4 mm <sup>2</sup> / 28 ... 12 AWG
Strip length	8 ... 9 mm / 0.31 ... 0.35 inch
Total number of connection points	2
Total number of potentials	1
Number of levels	1
Type of wiring	Front-entry wiring

#### Geometrical Data

Width	5 mm / 0.197 inch
Height from upper-edge of DIN-35 rail	28,5 mm / 1.122 inch
Depth	52,5 mm / 2.067 inch

#### Mechanical data

Design	horizontal
Type of mounting	DIN-35 rail
Marking level	Center marking

#### Material Data

Color	green-yellow
Insulating material	Polyamide 66 (PA 66)
Fire load	0.101 MJ
Weight	6.8 g

Subject to changes. Please also observe the further product documentation!

WAGO Kontakttechnik GmbH & Co. KG  
 Hansastr. 27  
 32423 Minden  
 Phone: +49571 887-0 | Fax: +49571 887-169  
 Email: [info.de@wago.com](mailto:info.de@wago.com) | Web: [www.wago.com](http://www.wago.com)



Do you have any questions about our products?  
 We are always happy to take your call at +49 (571) 887-44222.

## Commercial data



Product Group	18 (X-COM-System)
Packaging type	BOX
Country of origin	DE
GTIN	4044918827843
Customs Tariff No.	85366990990

## Approvals / Certificates

### Country specific Approvals



Logo	Approval	Additional Approval Text	Certificate name
	CCA DEKRA Certification B.V.	EN 60947	NTR NL-7626
	CSA DEKRA Certification B.V.	C22.2 No. 158	1101144
	KEMA/KEUR DEKRA Certification B.V.	EN 60947	2190419.01

### Ship Approvals

Logo	Approval	Additional Approval Text	Certificate name
	ABS American Bureau of Shipping	EN 60947	20-HG1941090-PDA
	DNV GL Det Norske Veritas, Germanischer Lloyd	-	TAE00001V2
	LR Lloyds Register	EN 60947	91/20112 (E9)

### UL-Approvals

Subject to changes. Please also observe the further product documentation!

Logo	Approval	Additional Approval Text	Certificate name
	UR Underwriters Laboratories Inc.	UL 1059	20190731-E45172
	UR Underwriters Laboratories Inc.	UL 1977	20151210-E45171







## Counterpart

## Compatible products

### ferrule

	<b>Item no.: 216-101</b> Ferrule; Sleeve for 0.5 mm <sup>2</sup> / AWG 22; uninsulated; electro-tin plated	<a href="http://www.wago.com/216-101">www.wago.com/216-101</a>
	<b>Item no.: 216-102</b> Ferrule; Sleeve for 0.75 mm <sup>2</sup> / AWG 20; uninsulated; electro-tin plated	<a href="http://www.wago.com/216-102">www.wago.com/216-102</a>
	<b>Item no.: 216-103</b> Ferrule; Sleeve for 1 mm <sup>2</sup> / AWG 18; uninsulated; electro-tin plated	<a href="http://www.wago.com/216-103">www.wago.com/216-103</a>
	<b>Item no.: 216-104</b> Ferrule; Sleeve for 1.5 mm <sup>2</sup> / AWG 16; uninsulated; electro-tin plated	<a href="http://www.wago.com/216-104">www.wago.com/216-104</a>
	<b>Item no.: 216-201</b> Ferrule; Sleeve for 0.5 mm <sup>2</sup> / 20 AWG; insulated; electro-tin plated; white	<a href="http://www.wago.com/216-201">www.wago.com/216-201</a>
	<b>Item no.: 216-202</b> Ferrule; Sleeve for 0.75 mm <sup>2</sup> / 18 AWG; insulated; electro-tin plated; gray	<a href="http://www.wago.com/216-202">www.wago.com/216-202</a>

Subject to changes. Please also observe the further product documentation!

	<b>Item no.: 216-203</b> Ferrule; Sleeve for 1 mm <sup>2</sup> / AWG 18; insulated; electro-tin plated; red	<a href="http://www.wago.com/216-203">www.wago.com/216-203</a>
	<b>Item no.: 216-204</b> Ferrule; Sleeve for 1.5 mm <sup>2</sup> / AWG 16; insulated; electro-tin plated; black	<a href="http://www.wago.com/216-204">www.wago.com/216-204</a>
	<b>Item no.: 216-206</b> Ferrule; Sleeve for 2.5 mm <sup>2</sup> / AWG 14; insulated; electro-tin plated; blue	<a href="http://www.wago.com/216-206">www.wago.com/216-206</a>
	<b>Item no.: 216-301</b> Ferrule; Sleeve for 0.25 mm <sup>2</sup> / AWG 24; insulated; electro-tin plated; yellow	<a href="http://www.wago.com/216-301">www.wago.com/216-301</a>
	<b>Item no.: 216-302</b> Ferrule; Sleeve for 0.34 mm <sup>2</sup> / 22 AWG; insulated; electro-tin plated; green	<a href="http://www.wago.com/216-302">www.wago.com/216-302</a>
<b>Marking accessories</b>		
	<b>Item no.: 2009-145</b> Mini-WSB Inline; for Smart Printer; 1700 pieces on roll; stretchable 5 - 5.2 mm; plain; snap-on type; white	<a href="http://www.wago.com/2009-145">www.wago.com/2009-145</a>
	<b>Item no.: 2009-145/000-002</b> Mini-WSB Inline; for Smart Printer; 1700 pieces on roll; stretchable 5 - 5.2 mm; plain; snap-on type; white /000-002	<a href="http://www.wago.com/2009-145">www.wago.com/2009-145</a>
	<b>Item no.: 2009-145/000-005</b> Mini-WSB Inline; for Smart Printer; 1700 pieces on roll; stretchable 5 - 5.2 mm; plain; snap-on type; red /000-005	<a href="http://www.wago.com/2009-145">www.wago.com/2009-145</a>
	<b>Item no.: 2009-145/000-006</b> Mini-WSB Inline; for Smart Printer; 1700 pieces on roll; stretchable 5 - 5.2 mm; plain; snap-on type; blue /000-006	<a href="http://www.wago.com/2009-145">www.wago.com/2009-145</a>
	<b>Item no.: 2009-145/000-007</b> Mini-WSB Inline; for Smart Printer; 1700 pieces on roll; stretchable 5 - 5.2 mm; plain; snap-on type; white /000-007	<a href="http://www.wago.com/2009-145">www.wago.com/2009-145</a>
	<b>Item no.: 2009-145/000-012</b> Mini-WSB Inline; for Smart Printer; 1700 pieces on roll; stretchable 5 - 5.2 mm; plain; snap-on type; orange	<a href="http://www.wago.com/2009-145">www.wago.com/2009-145</a>
	<b>Item no.: 2009-145/000-023</b> Mini-WSB Inline; for Smart Printer; 1700 pieces on roll; stretchable 5 - 5.2 mm; plain; snap-on type; green	<a href="http://www.wago.com/2009-145">www.wago.com/2009-145</a>
	<b>Item no.: 2009-145/000-024</b> Mini-WSB Inline; for Smart Printer; 1700 pieces on roll; stretchable 5 - 5.2 mm; plain; snap-on type; violet	<a href="http://www.wago.com/2009-145">www.wago.com/2009-145</a>
	<b>Item no.: 248-501</b> Miniature WSB Quick marking system; plain; Marker width 5 mm; 10 strips with 10 markers per card	<a href="http://www.wago.com/248-501">www.wago.com/248-501</a>
	<b>Item no.: 248-501/000-002</b> Mini-WSB marking card; as card; not stretchable; plain; snap-on type; yellow	<a href="http://www.wago.com/248-501">www.wago.com/248-501</a>

Subject to changes. Please also observe the further product documentation!



**Item no.: 248-501/000-005**  
Mini-WSB marking card; as card; not stretchable; plain; snap-on type; red

[www.wago.com/248-501/000-005](http://www.wago.com/248-501/000-005)



**Item no.: 248-501/000-006**  
Mini-WSB marking card; as card; not stretchable; plain; snap-on type; blue

[www.wago.com/248-501/000-006](http://www.wago.com/248-501/000-006)

**Item no.: 248-501/000-007**  
Mini-WSB marking card; as card; not stretchable; plain; snap-on type; gray

[www.wago.com/248-501/000-007](http://www.wago.com/248-501/000-007)

**Item no.: 248-501/000-012**  
Mini-WSB marking card; as card; not stretchable; plain; snap-on type; orange

[www.wago.com/248-501/000-012](http://www.wago.com/248-501/000-012)



**Item no.: 248-501/000-017**  
Mini-WSB marking card; as card; not stretchable; plain; snap-on type; light green

[www.wago.com/248-501/000-017](http://www.wago.com/248-501/000-017)



**Item no.: 248-501/000-023**  
Mini-WSB marking card; as card; not stretchable; plain; snap-on type; green

[www.wago.com/248-501/000-023](http://www.wago.com/248-501/000-023)

**Item no.: 248-501/000-024**  
Mini-WSB marking card; as card; not stretchable; plain; snap-on type; violet

[www.wago.com/248-501/000-024](http://www.wago.com/248-501/000-024)

## Jumper



**Item no.: 249-123**  
Push-in type wire jumper; insulated; wire length 180 mm; Conductor cross section 0.75 mm<sup>2</sup>

[www.wago.com/249-123](http://www.wago.com/249-123)



**Item no.: 249-125**  
Push-in type wire jumper; insulated; wire length 60 mm; Conductor cross section 0.75 mm<sup>2</sup>

[www.wago.com/249-125](http://www.wago.com/249-125)



**Item no.: 249-126**  
Push-in type wire jumper; insulated; wire length 110 mm; Conductor cross section 0.75 mm<sup>2</sup>

[www.wago.com/249-126](http://www.wago.com/249-126)



**Item no.: 249-127**  
Push-in type wire jumper; insulated; wire length 250 mm; Conductor cross section 0.75 mm<sup>2</sup>

[www.wago.com/249-127](http://www.wago.com/249-127)



**Item no.: 280-402**  
Adjacent jumper; insulated; IN = IN terminal block; gray

[www.wago.com/280-402](http://www.wago.com/280-402)



**Item no.: 280-409**  
Alternate jumper; insulated; IN = IN terminal block; gray

[www.wago.com/280-409](http://www.wago.com/280-409)



**Item no.: 280-422**  
Adjacent jumper; insulated; IN = IN terminal block; yellow-green















[www.wago.com/280-422](http://www.wago.com/280-422)















**Item no.: 780-452**  
Staggered jumper; insulated; from 1 to 2; Spacing: 5 mm; suitable for 2-conductor female plugs; gray

[www.wago.com/780-452](http://www.wago.com/780-452)

Subject to changes. Please also observe the further product documentation!

	<b>Item no.: 780-453</b> Staggered jumper; insulated; from 1 to 3; Spacing: 5 mm; suitable for 2-conductor female plugs; gray	<a href="http://www.wago.com/780-453">www.wago.com/780-453</a>
	<b>Item no.: 780-454</b> Staggered jumper; insulated; from 1 to 4; Spacing: 5 mm; suitable for 2-conductor female plugs; gray	<a href="http://www.wago.com/780-454">www.wago.com/780-454</a>
	<b>Item no.: 780-455</b> Staggered jumper; insulated; from 1 to 5; Spacing: 5 mm; suitable for 2-conductor female plugs; gray	<a href="http://www.wago.com/780-455">www.wago.com/780-455</a>
	<b>Item no.: 780-456</b> Staggered jumper; insulated; from 1 to 6; Spacing: 5 mm; suitable for 2-conductor female plugs; gray	<a href="http://www.wago.com/780-456">www.wago.com/780-456</a>
	<b>Item no.: 780-457</b> Staggered jumper; insulated; from 1 to 7; Spacing: 5 mm; suitable for 2-conductor female plugs; gray	<a href="http://www.wago.com/780-457">www.wago.com/780-457</a>
	<b>Item no.: 780-458</b> Staggered jumper; insulated; from 1 to 8; Spacing: 5 mm; suitable for 2-conductor female plugs; gray	<a href="http://www.wago.com/780-458">www.wago.com/780-458</a>
<b>General accessories</b>		
	<b>Item no.: 769-438</b> Pin cover; with marker slot for miniature WSB; gray	<a href="http://www.wago.com/769-438">www.wago.com/769-438</a>
	<b>Item no.: 769-439</b> Pin cover; with marker slot for miniature WSB; orange	<a href="http://www.wago.com/769-439">www.wago.com/769-439</a>
	<b>Item no.: 769-501</b> Start module for 1-conductor female connector; with integrated end plate; 4 mm <sup>2</sup> ; 1-pole; 4,00 mm <sup>2</sup> ; gray	<a href="http://www.wago.com/769-501">www.wago.com/769-501</a>
	<b>Item no.: 769-501/000-006</b> Start module for 1-conductor female connector; 4 mm <sup>2</sup> ; 1-pole; 4,00 mm <sup>2</sup> ; blue	<a href="http://www.wago.com/769-501/000-006">www.wago.com/769-501/000-006</a>
	<b>Item no.: 769-501/000-016</b> Start module for 1-conductor female connector; with integrated end plate; 4 mm <sup>2</sup> ; 1-pole; 4,00 mm <sup>2</sup> ; green-yellow	<a href="http://www.wago.com/769-501/000-016">www.wago.com/769-501/000-016</a>
	<b>Item no.: 769-502</b> Center module for 1-conductor female connector; 4 mm <sup>2</sup> ; 1-pole; 4,00 mm <sup>2</sup> ; gray	<a href="http://www.wago.com/769-502">www.wago.com/769-502</a>
	<b>Item no.: 769-502/000-006</b> Center module for 1-conductor female connector; 4 mm <sup>2</sup> ; 1-pole; 4,00 mm <sup>2</sup> ; blue	<a href="http://www.wago.com/769-502/000-006">www.wago.com/769-502/000-006</a>
	<b>Item no.: 769-502/000-016</b> Center module for 1-conductor female connector; 4 mm <sup>2</sup> ; 1-pole; 4,00 mm <sup>2</sup> ; green-yellow	<a href="http://www.wago.com/769-502/000-016">www.wago.com/769-502/000-016</a>
	<b>Item no.: 769-503</b> End module for 1-conductor female connector; 4 mm <sup>2</sup> ; 1-pole; 4,00 mm <sup>2</sup> ; gray	<a href="http://www.wago.com/769-503">www.wago.com/769-503</a>
	<b>Item no.: 769-503/000-006</b> End module for 1-conductor female connector; 4 mm <sup>2</sup> ; 1-pole; 4,00 mm <sup>2</sup> ; blue	<a href="http://www.wago.com/769-503/000-006">www.wago.com/769-503/000-006</a>

Subject to changes. Please also observe the further product documentation!

	<b>Item no.: 769-503/000-016</b> End module for 1-conductor female connector; 4 mm <sup>2</sup> ; 1-pole; 4,00 mm <sup>2</sup> ; green-yellow	<a href="http://www.wago.com/769-503/000-016">www.wago.com/769-503/000-016</a>
	<b>Item no.: 769-504</b> Start module for 2-conductor female connector; with integrated end plate; 4 mm <sup>2</sup> ; 1-pole; 4,00 mm <sup>2</sup> ; gray	<a href="http://www.wago.com/769-504">www.wago.com/769-504</a>
	<b>Item no.: 769-504/000-006</b> Start module for 2-conductor female connector; with integrated end plate; 4 mm <sup>2</sup> ; 1-pole; 4,00 mm <sup>2</sup> ; blue	<a href="http://www.wago.com/769-504/000-006">www.wago.com/769-504/000-006</a>
	<b>Item no.: 769-504/000-016</b> Start module for 2-conductor female connector; 4 mm <sup>2</sup> ; 1-pole; 4,00 mm <sup>2</sup> ; green-yellow	<a href="http://www.wago.com/769-504/000-016">www.wago.com/769-504/000-016</a>
	<b>Item no.: 769-505</b> Center module for 2-conductor female connector; 4 mm <sup>2</sup> ; 1-pole; 4,00 mm <sup>2</sup> ; gray	<a href="http://www.wago.com/769-505">www.wago.com/769-505</a>
	<b>Item no.: 769-505/000-006</b> Center module for 2-conductor female connector; 4 mm <sup>2</sup> ; 1-pole; 4,00 mm <sup>2</sup> ; blue	<a href="http://www.wago.com/769-505/000-006">www.wago.com/769-505/000-006</a>
	<b>Item no.: 769-505/000-016</b> Center module for 2-conductor female connector; 4 mm <sup>2</sup> ; 1-pole; 4,00 mm <sup>2</sup> ; green-yellow	<a href="http://www.wago.com/769-505/000-016">www.wago.com/769-505/000-016</a>
	<b>Item no.: 769-506</b> End module for 2-conductor female connector; 4 mm <sup>2</sup> ; 1-pole; 4,00 mm <sup>2</sup> ; gray	<a href="http://www.wago.com/769-506">www.wago.com/769-506</a>
	<b>Item no.: 769-506/000-006</b> End module for 2-conductor female connector; 4 mm <sup>2</sup> ; 1-pole; 4,00 mm <sup>2</sup> ; blue	<a href="http://www.wago.com/769-506/000-006">www.wago.com/769-506/000-006</a>
	<b>Item no.: 769-506/000-016</b> End module for 2-conductor female connector; 4 mm <sup>2</sup> ; 1-pole; 4,00 mm <sup>2</sup> ; green-yellow	<a href="http://www.wago.com/769-506/000-016">www.wago.com/769-506/000-016</a>
	<b>Item no.: 769-512</b> Start module for 1-conductor female connector; angled; 4 mm <sup>2</sup> ; 1-pole; 4,00 mm <sup>2</sup> ; gray	<a href="http://www.wago.com/769-512">www.wago.com/769-512</a>
	<b>Item no.: 769-512/000-006</b> Start module for 1-conductor female connector; angled; 4 mm <sup>2</sup> ; 1-pole; 4,00 mm <sup>2</sup> ; blue	<a href="http://www.wago.com/769-512/000-006">www.wago.com/769-512/000-006</a>
	<b>Item no.: 769-512/000-016</b> Start module for 1-conductor female connector; angled; 4 mm <sup>2</sup> ; 1-pole; 4,00 mm <sup>2</sup> ; green-yellow	<a href="http://www.wago.com/769-512/000-016">www.wago.com/769-512/000-016</a>
	<b>Item no.: 769-513</b> Center module for 1-conductor female connector; angled; 4 mm <sup>2</sup> ; 1-pole; 4,00 mm <sup>2</sup> ; gray	<a href="http://www.wago.com/769-513">www.wago.com/769-513</a>

Subject to changes. Please also observe the further product documentation!





**Item no.: 769-513/000-006**  
Center module for 1-conductor female connector; angled; 4 mm<sup>2</sup>; 1-pole; 4,00 mm<sup>2</sup>; blue

[www.wago.com/769-513/000-006](http://www.wago.com/769-513/000-006)



**Item no.: 769-513/000-016**  
Center module for 1-conductor female connector; angled; 4 mm<sup>2</sup>; 1-pole; 4,00 mm<sup>2</sup>; green-yellow

[www.wago.com/769-513/000-016](http://www.wago.com/769-513/000-016)



**Item no.: 769-515**  
End module for 1-conductor female connector; angled; 4 mm<sup>2</sup>; 1-pole; 4,00 mm<sup>2</sup>; gray

[www.wago.com/769-515](http://www.wago.com/769-515)



**Item no.: 769-515/000-006**  
End module for 1-conductor female connector; angled; 4 mm<sup>2</sup>; 1-pole; 4,00 mm<sup>2</sup>; blue

[www.wago.com/769-515/000-006](http://www.wago.com/769-515/000-006)



**Item no.: 769-515/000-016**  
End module for 1-conductor female connector; angled; 4 mm<sup>2</sup>; 1-pole; 4,00 mm<sup>2</sup>; green-yellow

[www.wago.com/769-515/000-016](http://www.wago.com/769-515/000-016)

#### Test Accessories

**Item no.: 210-136**  
Test plug; 2 mm Ø; with 500 mm cable; red

[www.wago.com/210-136](http://www.wago.com/210-136)



**Item no.: 210-137**  
Test plug; 2.3 mm Ø; with 500 mm cable; yellow

[www.wago.com/210-137](http://www.wago.com/210-137)

**Item no.: 280-404**  
Test plug adapter; 5 mm wide; for test plug 210-137 (2.3 mm Ø); suitable for 1.5 mm<sup>2</sup> - 4 mm<sup>2</sup> tbs; gray

[www.wago.com/280-404](http://www.wago.com/280-404)

**Item no.: 280-418**  
Test plug module; modular; suitable for all WAGO 280 and 780 Series rail-mounted terminal blocks with jumper slots in the current bar; gray

[www.wago.com/280-418](http://www.wago.com/280-418)

**Item no.: 280-419**  
Spacer module; modular; bridging commoned terminal blocks; gray

[www.wago.com/280-419](http://www.wago.com/280-419)

#### Insulation stop



**Item no.: 769-470**  
Insulation stop; 0.08 - 0.2 mm<sup>2</sup> "s" (0.14 mm<sup>2</sup> "f-st"); 5 pieces/strip; white

[www.wago.com/769-470](http://www.wago.com/769-470)



**Item no.: 769-471**  
Insulation stop; 0.25 - 0.5 mm<sup>2</sup>; 5 pieces/strip; light gray

[www.wago.com/769-471](http://www.wago.com/769-471)

**Item no.: 769-472**  
Insulation stop; 0.75 - 1 mm<sup>2</sup>; 5 pieces/strip; dark gray

[www.wago.com/769-472](http://www.wago.com/769-472)

#### Protective Warning Marker

**Item no.: 280-415**  
Protective warning marker; with high-voltage symbol, black; for 5 terminal blocks; yellow

[www.wago.com/280-415](http://www.wago.com/280-415)

#### Coding



**Item no.: 769-435**  
Coding pin; for coding of female plugs; for carrier terminal blocks / male connectors; orange

[www.wago.com/769-435](http://www.wago.com/769-435)

Subject to changes. Please also observe the further product documentation!

## assembling

**Item no.: 209-106**

Mounting carrier; for isolated mounting on DIN 35 rails; gray

[www.wago.com/209-106](http://www.wago.com/209-106)

## Carrier rail

**Item no.: 210-112**

Steel carrier rail; 35 x 7.5 mm; 1 mm thick; 2 m long; slotted; according to EN 60715; "Hole width 25 mm

[www.wago.com/210-112](http://www.wago.com/210-112)**Item no.: 210-113**

Steel carrier rail; 35 x 7.5 mm; 1 mm thick; 2 m long; unslotted; according to EN 60715

[www.wago.com/210-113](http://www.wago.com/210-113)**Item no.: 210-114**

Steel carrier rail; 35 x 15 mm; 1.5 mm thick; 2 m long; unslotted; similar to EN 60715

[www.wago.com/210-114](http://www.wago.com/210-114)**Item no.: 210-115**

Steel carrier rail; 35 x 7.5 mm; 1 mm thick; 2 m long; slotted; according to EN 60715; "Hole width 18 mm

[www.wago.com/210-115](http://www.wago.com/210-115)**Item no.: 210-118**

Steel carrier rail; 35 x 15 mm; 2.3 mm thick; 2 m long; unslotted; according to EN 60715

[www.wago.com/210-118](http://www.wago.com/210-118)**Item no.: 210-196**

Aluminum carrier rail; 35 x 8.2 mm; 1.6 mm thick; 2 m long; unslotted; similar to EN 60715; silver-colored

[www.wago.com/210-196](http://www.wago.com/210-196)**Item no.: 210-197**

Steel carrier rail; 35 x 15 mm; 1.5 mm thick; 2 m long; slotted; similar to EN 60715

[www.wago.com/210-197](http://www.wago.com/210-197)**Item no.: 210-198**

Copper carrier rail; 35 x 15 mm; 2.3 mm thick; 2 m long; unslotted; according to EN 60715; copper-colored

[www.wago.com/210-198](http://www.wago.com/210-198)**Item no.: 210-504**

Steel carrier rail; 35 x 7.5 mm; 1 mm thick; 2 m long; slotted; galvanized; according to EN 60715

[www.wago.com/210-504](http://www.wago.com/210-504)**Item no.: 210-505**

Steel carrier rail; 35 x 7.5 mm; 1 mm thick; 2 m long; unslotted; galvanized; according to EN 60715

[www.wago.com/210-505](http://www.wago.com/210-505)**Item no.: 210-506**

Steel carrier rail; 35 x 15 mm; 1.5 mm thick; 2 m long; unslotted; galvanized; similar to EN 60715

[www.wago.com/210-506](http://www.wago.com/210-506)**Item no.: 210-508**

Steel carrier rail; 35 x 15 mm; 1.5 mm thick; 2 m long; slotted; galvanized; similar to EN 60715

[www.wago.com/210-508](http://www.wago.com/210-508)

## Female plug

**Item no.: 769-101**1-conductor female plug; 4 mm<sup>2</sup>; 1-pole; 4,00 mm<sup>2</sup>; gray[www.wago.com/769-101](http://www.wago.com/769-101)**Item no.: 769-101/000-006**1-conductor female plug; 4 mm<sup>2</sup>; 1-pole; 4,00 mm<sup>2</sup>; blue[www.wago.com/769-101/000-006](http://www.wago.com/769-101/000-006)**Item no.: 769-101/000-016**1-conductor female plug; 4 mm<sup>2</sup>; 1-pole; 4,00 mm<sup>2</sup>; green-yellow[www.wago.com/769-101/000-016](http://www.wago.com/769-101/000-016)

Subject to changes. Please also observe the further product documentation!

WAGO Kontakttechnik GmbH &amp; Co. KG

Hansastr. 27

32423 Minden

Phone: +49571 887-0 | Fax: +49571 887-169

Email: [info.de@wago.com](mailto:info.de@wago.com) | Web: [www.wago.com](http://www.wago.com)

Do you have any questions about our products?

We are always happy to take your call at +49 (571) 887-44222.



**Item no.: 769-101/022-000**  
1-conductor female plug; angled; 4 mm<sup>2</sup>; 1-pole; 4,00 mm<sup>2</sup>; gray

[www.wago.com/769-101/022-000](http://www.wago.com/769-101/022-000)



**Item no.: 769-101/022-016**  
1-conductor female plug; angled; 4 mm<sup>2</sup>; 1-pole; 4,00 mm<sup>2</sup>; green-yellow

[www.wago.com/769-101/022-016](http://www.wago.com/769-101/022-016)



**Item no.: 769-102**  
1-conductor female plug; 4 mm<sup>2</sup>; 2-pole; 4,00 mm<sup>2</sup>; gray

[www.wago.com/769-102](http://www.wago.com/769-102)



**Item no.: 769-102/000-006**  
1-conductor female plug; 4 mm<sup>2</sup>; 2-pole; 4,00 mm<sup>2</sup>; blue

[www.wago.com/769-102/000-006](http://www.wago.com/769-102/000-006)

**Item no.: 769-102/000-036**  
1-conductor female plug; 4 mm<sup>2</sup>; 2-pole; 4,00 mm<sup>2</sup>; gray, green-yellow

[www.wago.com/769-102/000-036](http://www.wago.com/769-102/000-036)



**Item no.: 769-102/000-037**  
1-conductor female plug; 4 mm<sup>2</sup>; 2-pole; 4,00 mm<sup>2</sup>; green-yellow, gray

[www.wago.com/769-102/000-037](http://www.wago.com/769-102/000-037)



**Item no.: 769-102/022-000**  
1-conductor female plug; angled; 4 mm<sup>2</sup>; 2-pole; 4,00 mm<sup>2</sup>; gray

[www.wago.com/769-102/022-000](http://www.wago.com/769-102/022-000)



**Item no.: 769-103**  
1-conductor female plug; 4 mm<sup>2</sup>; 3-pole; 4,00 mm<sup>2</sup>; gray

[www.wago.com/769-103](http://www.wago.com/769-103)



**Item no.: 769-103/000-006**  
1-conductor female plug; 4 mm<sup>2</sup>; 3-pole; 4,00 mm<sup>2</sup>; blue

[www.wago.com/769-103/000-006](http://www.wago.com/769-103/000-006)



**Item no.: 769-103/000-036**  
1-conductor female plug; 4 mm<sup>2</sup>; 3-pole; 4,00 mm<sup>2</sup>; gray, green-yellow

[www.wago.com/769-103/000-036](http://www.wago.com/769-103/000-036)



**Item no.: 769-103/000-037**  
1-conductor female plug; 4 mm<sup>2</sup>; 3-pole; 4,00 mm<sup>2</sup>; green-yellow, gray

[www.wago.com/769-103/000-037](http://www.wago.com/769-103/000-037)

**Item no.: 769-103/000-038**  
1-conductor female plug; 4 mm<sup>2</sup>; 3-pole; 4,00 mm<sup>2</sup>; gray, blue, green-yellow

[www.wago.com/769-103/000-038](http://www.wago.com/769-103/000-038)



**Item no.: 769-103/000-039**  
1-conductor female plug; 4 mm<sup>2</sup>; 3-pole; 4,00 mm<sup>2</sup>; green-yellow, blue, gray

[www.wago.com/769-103/000-039](http://www.wago.com/769-103/000-039)

**Item no.: 769-103/022-000**  
1-conductor female plug; angled; 4 mm<sup>2</sup>; 3-pole; 4,00 mm<sup>2</sup>; gray

[www.wago.com/769-103/022-000](http://www.wago.com/769-103/022-000)

Subject to changes. Please also observe the further product documentation!



**Item no.: 769-104**

1-conductor female plug; 4 mm²; 4-pole; 4,00 mm²; gray

[www.wago.com/769-104](http://www.wago.com/769-104)



**Item no.: 769-104/000-006**

1-conductor female plug; 4 mm²; 4-pole; 4,00 mm²; blue

[www.wago.com/769-104/000-006](http://www.wago.com/769-104/000-006)



**Item no.: 769-104/000-036**

1-conductor female plug; 4 mm²; 4-pole; 4,00 mm²; gray, green-yellow

[www.wago.com/769-104/000-036](http://www.wago.com/769-104/000-036)



**Item no.: 769-104/000-037**

1-conductor female plug; 4 mm²; 4-pole; 4,00 mm²; green-yellow, gray

[www.wago.com/769-104/000-037](http://www.wago.com/769-104/000-037)

**Item no.: 769-104/000-038**

1-conductor female plug; 4 mm²; 4-pole; 4,00 mm²; gray, blue, green-yellow

[www.wago.com/769-104/000-038](http://www.wago.com/769-104/000-038)

**Item no.: 769-104/000-039**

1-conductor female plug; 4 mm²; 4-pole; 4,00 mm²; green-yellow, blue, gray

[www.wago.com/769-104/000-039](http://www.wago.com/769-104/000-039)

**Item no.: 769-104/022-000**

1-conductor female plug; angled; 4 mm²; 4-pole; 4,00 mm²; gray

[www.wago.com/769-104/022-000](http://www.wago.com/769-104/022-000)



**Item no.: 769-105**

1-conductor female plug; 4 mm²; 5-pole; 4,00 mm²; gray

[www.wago.com/769-105](http://www.wago.com/769-105)



**Item no.: 769-105/000-006**

1-conductor female plug; 4 mm²; 5-pole; 4,00 mm²; blue

[www.wago.com/769-105/000-006](http://www.wago.com/769-105/000-006)



**Item no.: 769-105/000-036**

1-conductor female plug; 4 mm²; 5-pole; 4,00 mm²; gray, green-yellow

[www.wago.com/769-105/000-036](http://www.wago.com/769-105/000-036)

**Item no.: 769-105/000-037**

1-conductor female plug; 4 mm²; 5-pole; 4,00 mm²; green-yellow, gray

[www.wago.com/769-105/000-037](http://www.wago.com/769-105/000-037)



**Item no.: 769-105/000-038**

1-conductor female plug; 4 mm²; 5-pole; 4,00 mm²; gray, blue, green-yellow

[www.wago.com/769-105/000-038](http://www.wago.com/769-105/000-038)



**Item no.: 769-105/000-039**

1-conductor female plug; 4 mm²; 5-pole; 4,00 mm²; green-yellow, blue, gray

[www.wago.com/769-105/000-039](http://www.wago.com/769-105/000-039)



**Item no.: 769-105/022-000**

1-conductor female plug; angled; 4 mm²; 5-pole; 4,00 mm²; gray

[www.wago.com/769-105/022-000](http://www.wago.com/769-105/022-000)

Subject to changes. Please also observe the further product documentation!

WAGO Kontakttechnik GmbH & Co. KG

Hansastr. 27

32423 Minden

Phone: +49571 887-0 | Fax: +49571 887-169

Email: [info.de@wago.com](mailto:info.de@wago.com) | Web: [www.wago.com](http://www.wago.com)

Do you have any questions about our products?

We are always happy to take your call at +49 (571) 887-44222.

**Item no.: 769-106**

1-conductor female plug; 4 mm<sup>2</sup>; 6-pole; 4,00 mm<sup>2</sup>; gray

[www.wago.com/769-106](http://www.wago.com/769-106)



**Item no.: 769-106/000-006**

1-conductor female plug; 4 mm<sup>2</sup>; 6-pole; 4,00 mm<sup>2</sup>; blue

[www.wago.com/769-106/000-006](http://www.wago.com/769-106/000-006)



**Item no.: 769-106/000-036**

1-conductor female plug; 4 mm<sup>2</sup>; 6-pole; 4,00 mm<sup>2</sup>; gray, green-yellow

[www.wago.com/769-106/000-036](http://www.wago.com/769-106/000-036)

**Item no.: 769-106/000-037**

1-conductor female plug; 4 mm<sup>2</sup>; 6-pole; 4,00 mm<sup>2</sup>; green-yellow, gray

[www.wago.com/769-106/000-037](http://www.wago.com/769-106/000-037)

**Item no.: 769-106/000-038**

1-conductor female plug; 4 mm<sup>2</sup>; 6-pole; 4,00 mm<sup>2</sup>; gray, blue, green-yellow

[www.wago.com/769-106/000-038](http://www.wago.com/769-106/000-038)

**Item no.: 769-106/000-039**

1-conductor female plug; 4 mm<sup>2</sup>; 6-pole; 4,00 mm<sup>2</sup>; green-yellow, blue, gray

[www.wago.com/769-106/000-039](http://www.wago.com/769-106/000-039)



**Item no.: 769-106/022-000**

1-conductor female plug; angled; 4 mm<sup>2</sup>; 6-pole; 4,00 mm<sup>2</sup>; gray

[www.wago.com/769-106/022-000](http://www.wago.com/769-106/022-000)



**Item no.: 769-107**

1-conductor female plug; 4 mm<sup>2</sup>; 7-pole; 4,00 mm<sup>2</sup>; gray

[www.wago.com/769-107](http://www.wago.com/769-107)

**Item no.: 769-107/000-006**

1-conductor female plug; 4 mm<sup>2</sup>; 7-pole; 4,00 mm<sup>2</sup>; blue

[www.wago.com/769-107/000-006](http://www.wago.com/769-107/000-006)



**Item no.: 769-107/000-036**

1-conductor female plug; 4 mm<sup>2</sup>; 7-pole; 4,00 mm<sup>2</sup>; gray, green-yellow

[www.wago.com/769-107/000-036](http://www.wago.com/769-107/000-036)



**Item no.: 769-107/000-037**

1-conductor female plug; 4 mm<sup>2</sup>; 7-pole; 4,00 mm<sup>2</sup>; green-yellow, gray

[www.wago.com/769-107/000-037](http://www.wago.com/769-107/000-037)

**Item no.: 769-107/000-038**

1-conductor female plug; 4 mm<sup>2</sup>; 7-pole; 4,00 mm<sup>2</sup>; gray, blue, green-yellow

[www.wago.com/769-107/000-038](http://www.wago.com/769-107/000-038)

**Item no.: 769-107/000-039**

1-conductor female plug; 4 mm<sup>2</sup>; 7-pole; 4,00 mm<sup>2</sup>; green-yellow, blue, gray

[www.wago.com/769-107/000-039](http://www.wago.com/769-107/000-039)

**Item no.: 769-107/022-000**

1-conductor female plug; angled; 4 mm<sup>2</sup>; 7-pole; 4,00 mm<sup>2</sup>; gray

[www.wago.com/769-107/022-000](http://www.wago.com/769-107/022-000)

Subject to changes. Please also observe the further product documentation!

WAGO Kontakttechnik GmbH & Co. KG

Hansastr. 27

32423 Minden

Phone: +49571 887-0 | Fax: +49571 887-169

Email: [info.de@wago.com](mailto:info.de@wago.com) | Web: [www.wago.com](http://www.wago.com)

Do you have any questions about our products?

We are always happy to take your call at +49 (571) 887-44222.



**Item no.: 769-108**

1-conductor female plug; 4 mm<sup>2</sup>; 8-pole; 4,00 mm<sup>2</sup>; gray

[www.wago.com/769-108](http://www.wago.com/769-108)



**Item no.: 769-108/000-006**

1-conductor female plug; 4 mm<sup>2</sup>; 8-pole; 4,00 mm<sup>2</sup>; blue

[www.wago.com/769-108/000-006](http://www.wago.com/769-108/000-006)



**Item no.: 769-108/000-036**

1-conductor female plug; 4 mm<sup>2</sup>; 8-pole; 4,00 mm<sup>2</sup>; gray, green-yellow

[www.wago.com/769-108/000-036](http://www.wago.com/769-108/000-036)



**Item no.: 769-108/000-037**

1-conductor female plug; 4 mm<sup>2</sup>; 8-pole; 4,00 mm<sup>2</sup>; green-yellow, gray

[www.wago.com/769-108/000-037](http://www.wago.com/769-108/000-037)



**Item no.: 769-108/000-038**

1-conductor female plug; 4 mm<sup>2</sup>; 8-pole; 4,00 mm<sup>2</sup>; gray, blue, green-yellow

[www.wago.com/769-108/000-038](http://www.wago.com/769-108/000-038)



**Item no.: 769-108/000-039**

1-conductor female plug; 4 mm<sup>2</sup>; 8-pole; 4,00 mm<sup>2</sup>; green-yellow, blue, gray

[www.wago.com/769-108/000-039](http://www.wago.com/769-108/000-039)



**Item no.: 769-108/022-000**

1-conductor female plug; angled; 4 mm<sup>2</sup>; 8-pole; 4,00 mm<sup>2</sup>; gray

[www.wago.com/769-108/022-000](http://www.wago.com/769-108/022-000)



**Item no.: 769-109**

1-conductor female plug; 4 mm<sup>2</sup>; 9-pole; 4,00 mm<sup>2</sup>; gray

[www.wago.com/769-109](http://www.wago.com/769-109)



**Item no.: 769-109/000-006**

1-conductor female plug; 4 mm<sup>2</sup>; 9-pole; 4,00 mm<sup>2</sup>; blue

[www.wago.com/769-109/000-006](http://www.wago.com/769-109/000-006)



**Item no.: 769-109/000-036**

1-conductor female plug; 4 mm<sup>2</sup>; 9-pole; 4,00 mm<sup>2</sup>; gray, green-yellow

[www.wago.com/769-109/000-036](http://www.wago.com/769-109/000-036)



**Item no.: 769-109/000-037**

1-conductor female plug; 4 mm<sup>2</sup>; 9-pole; 4,00 mm<sup>2</sup>; green-yellow, gray

[www.wago.com/769-109/000-037](http://www.wago.com/769-109/000-037)



**Item no.: 769-109/000-038**

1-conductor female plug; 4 mm<sup>2</sup>; 9-pole; 4,00 mm<sup>2</sup>; gray, blue, green-yellow

[www.wago.com/769-109/000-038](http://www.wago.com/769-109/000-038)



**Item no.: 769-109/000-039**

1-conductor female plug; 4 mm<sup>2</sup>; 9-pole; 4,00 mm<sup>2</sup>; green-yellow, blue, gray

[www.wago.com/769-109/000-039](http://www.wago.com/769-109/000-039)



**Item no.: 769-109/022-000**

1-conductor female plug; angled; 4 mm<sup>2</sup>; 9-pole; 4,00 mm<sup>2</sup>; gray

[www.wago.com/769-109/022-000](http://www.wago.com/769-109/022-000)

Subject to changes. Please also observe the further product documentation!

WAGO Kontakttechnik GmbH & Co. KG

Hansastr. 27















32423 Minden

Phone: +49571 887-0 | Fax: +49571 887-169

Email: [info.de@wago.com](mailto:info.de@wago.com) | Web: [www.wago.com](http://www.wago.com)

Do you have any questions about our products?

We are always happy to take your call at +49 (571) 887-44222.

	<b>Item no.: 769-110</b> 1-conductor female plug; 4 mm <sup>2</sup> ; 10-pole; 4,00 mm <sup>2</sup> ; gray	<a href="http://www.wago.com/769-110">www.wago.com/769-110</a>
	<b>Item no.: 769-110/000-006</b> 1-conductor female plug; 4 mm <sup>2</sup> ; 10-pole; 4,00 mm <sup>2</sup> ; blue	<a href="http://www.wago.com/769-110/000-006">www.wago.com/769-110/000-006</a>
	<b>Item no.: 769-110/000-036</b> 1-conductor female plug; 4 mm <sup>2</sup> ; 10-pole; 4,00 mm <sup>2</sup> ; gray, green-yellow	<a href="http://www.wago.com/769-110/000-036">www.wago.com/769-110/000-036</a>
	<b>Item no.: 769-110/000-037</b> 1-conductor female plug; 4 mm <sup>2</sup> ; 10-pole; 4,00 mm <sup>2</sup> ; green-yellow, gray	<a href="http://www.wago.com/769-110/000-037">www.wago.com/769-110/000-037</a>
	<b>Item no.: 769-110/000-038</b> 1-conductor female plug; 4 mm <sup>2</sup> ; 10-pole; 4,00 mm <sup>2</sup> ; gray, blue, green-yellow	<a href="http://www.wago.com/769-110/000-038">www.wago.com/769-110/000-038</a>
	<b>Item no.: 769-110/000-039</b> 1-conductor female plug; 4 mm <sup>2</sup> ; 10-pole; 4,00 mm <sup>2</sup> ; green-yellow, blue, gray	<a href="http://www.wago.com/769-110/000-039">www.wago.com/769-110/000-039</a>
	<b>Item no.: 769-110/022-000</b> 1-conductor female plug; angled; 4 mm <sup>2</sup> ; 10-pole; 4,00 mm <sup>2</sup> ; gray	<a href="http://www.wago.com/769-110/022-000">www.wago.com/769-110/022-000</a>
	<b>Item no.: 769-111</b> 1-conductor female plug; 4 mm <sup>2</sup> ; 11-pole; 4,00 mm <sup>2</sup> ; gray	<a href="http://www.wago.com/769-111">www.wago.com/769-111</a>
	<b>Item no.: 769-111/000-006</b> 1-conductor female plug; 4 mm <sup>2</sup> ; 11-pole; 4,00 mm <sup>2</sup> ; blue	<a href="http://www.wago.com/769-111/000-006">www.wago.com/769-111/000-006</a>
	<b>Item no.: 769-111/000-036</b> 1-conductor female plug; 4 mm <sup>2</sup> ; 11-pole; 4,00 mm <sup>2</sup> ; gray, green-yellow	<a href="http://www.wago.com/769-111/000-036">www.wago.com/769-111/000-036</a>
	<b>Item no.: 769-111/000-037</b> 1-conductor female plug; 4 mm <sup>2</sup> ; 11-pole; 4,00 mm <sup>2</sup> ; green-yellow, gray	<a href="http://www.wago.com/769-111/000-037">www.wago.com/769-111/000-037</a>
	<b>Item no.: 769-111/000-038</b> 1-conductor female plug; 4 mm <sup>2</sup> ; 11-pole; 4,00 mm <sup>2</sup> ; gray, blue, green-yellow	<a href="http://www.wago.com/769-111/000-038">www.wago.com/769-111/000-038</a>
	<b>Item no.: 769-111/000-039</b> 1-conductor female plug; 4 mm <sup>2</sup> ; 11-pole; 4,00 mm <sup>2</sup> ; green-yellow, blue, gray	<a href="http://www.wago.com/769-111/000-039">www.wago.com/769-111/000-039</a>
	<b>Item no.: 769-111/022-000</b> 1-conductor female plug; angled; 4 mm <sup>2</sup> ; 11-pole; 4,00 mm <sup>2</sup> ; gray	<a href="http://www.wago.com/769-111/022-000">www.wago.com/769-111/022-000</a>

Subject to changes. Please also observe the further product documentation!



**Item no.: 769-112**

1-conductor female plug; 4 mm<sup>2</sup>; 12-pole; 4,00 mm<sup>2</sup>; gray

[www.wago.com/769-112](http://www.wago.com/769-112)



**Item no.: 769-112/000-006**

1-conductor female plug; 4 mm<sup>2</sup>; 12-pole; 4,00 mm<sup>2</sup>; blue

[www.wago.com/769-112/000-006](http://www.wago.com/769-112/000-006)



**Item no.: 769-112/000-036**

1-conductor female plug; 4 mm<sup>2</sup>; 12-pole; 4,00 mm<sup>2</sup>; gray, green-yellow

[www.wago.com/769-112/000-036](http://www.wago.com/769-112/000-036)



**Item no.: 769-112/000-037**

1-conductor female plug; 4 mm<sup>2</sup>; 12-pole; 4,00 mm<sup>2</sup>; green-yellow, gray

[www.wago.com/769-112/000-037](http://www.wago.com/769-112/000-037)



**Item no.: 769-112/000-038**

1-conductor female plug; 4 mm<sup>2</sup>; 12-pole; 4,00 mm<sup>2</sup>; gray, blue, green-yellow

[www.wago.com/769-112/000-038](http://www.wago.com/769-112/000-038)



**Item no.: 769-112/000-039**

1-conductor female plug; 4 mm<sup>2</sup>; 12-pole; 4,00 mm<sup>2</sup>; green-yellow, blue, gray

[www.wago.com/769-112/000-039](http://www.wago.com/769-112/000-039)



**Item no.: 769-112/022-000**

1-conductor female plug; angled; 4 mm<sup>2</sup>; 12-pole; 4,00 mm<sup>2</sup>; gray

[www.wago.com/769-112/022-000](http://www.wago.com/769-112/022-000)



**Item no.: 769-113**

1-conductor female plug; 4 mm<sup>2</sup>; 13-pole; 4,00 mm<sup>2</sup>; gray

[www.wago.com/769-113](http://www.wago.com/769-113)



**Item no.: 769-113/000-036**

1-conductor female plug; 4 mm<sup>2</sup>; 13-pole; 4,00 mm<sup>2</sup>; gray, green-yellow

[www.wago.com/769-113/000-036](http://www.wago.com/769-113/000-036)



**Item no.: 769-113/000-037**

1-conductor female plug; 4 mm<sup>2</sup>; 13-pole; 4,00 mm<sup>2</sup>; green-yellow, gray

[www.wago.com/769-113/000-037](http://www.wago.com/769-113/000-037)



**Item no.: 769-113/000-038**

1-conductor female plug; 4 mm<sup>2</sup>; 13-pole; 4,00 mm<sup>2</sup>; gray, blue, green-yellow

[www.wago.com/769-113/000-038](http://www.wago.com/769-113/000-038)



**Item no.: 769-113/000-039**

1-conductor female plug; 4 mm<sup>2</sup>; 13-pole; 4,00 mm<sup>2</sup>; green-yellow, blue, gray

[www.wago.com/769-113/000-039](http://www.wago.com/769-113/000-039)



**Item no.: 769-113/022-000**

1-conductor female plug; angled; 4 mm<sup>2</sup>; 13-pole; 4,00 mm<sup>2</sup>; gray

[www.wago.com/769-113/022-000](http://www.wago.com/769-113/022-000)



**Item no.: 769-114**

1-conductor female plug; 4 mm<sup>2</sup>; 14-pole; 4,00 mm<sup>2</sup>; gray

[www.wago.com/769-114](http://www.wago.com/769-114)

Subject to changes. Please also observe the further product documentation!

WAGO Kontakttechnik GmbH & Co. KG

Hansastr. 27

32423 Minden

Phone: +49571 887-0 | Fax: +49571 887-169

Email: [info.de@wago.com](mailto:info.de@wago.com) | Web: [www.wago.com](http://www.wago.com)

Do you have any questions about our products?

We are always happy to take your call at +49 (571) 887-44222.





**Item no.: 769-114/000-006**  
1-conductor female plug; 4 mm<sup>2</sup>; 14-pole; 4,00 mm<sup>2</sup>; blue

[www.wago.com/769-114/000-006](http://www.wago.com/769-114/000-006)



**Item no.: 769-114/000-036**  
1-conductor female plug; 4 mm<sup>2</sup>; 14-pole; 4,00 mm<sup>2</sup>; gray, green-yellow

[www.wago.com/769-114/000-036](http://www.wago.com/769-114/000-036)



**Item no.: 769-114/000-037**  
1-conductor female plug; 4 mm<sup>2</sup>; 14-pole; 4,00 mm<sup>2</sup>; green-yellow, gray

[www.wago.com/769-114/000-037](http://www.wago.com/769-114/000-037)



**Item no.: 769-114/000-038**  
1-conductor female plug; 4 mm<sup>2</sup>; 14-pole; 4,00 mm<sup>2</sup>; gray, blue, green-yellow

[www.wago.com/769-114/000-038](http://www.wago.com/769-114/000-038)



**Item no.: 769-114/000-039**  
1-conductor female plug; 4 mm<sup>2</sup>; 14-pole; 4,00 mm<sup>2</sup>; green-yellow, blue, gray

[www.wago.com/769-114/000-039](http://www.wago.com/769-114/000-039)



**Item no.: 769-114/022-000**  
1-conductor female plug; angled; 4 mm<sup>2</sup>; 14-pole; 4,00 mm<sup>2</sup>; gray

[www.wago.com/769-114/022-000](http://www.wago.com/769-114/022-000)



**Item no.: 769-115**  
1-conductor female plug; 4 mm<sup>2</sup>; 15-pole; 4,00 mm<sup>2</sup>; gray

[www.wago.com/769-115](http://www.wago.com/769-115)



**Item no.: 769-115/000-036**  
1-conductor female plug; 4 mm<sup>2</sup>; 15-pole; 4,00 mm<sup>2</sup>; gray, green-yellow

[www.wago.com/769-115/000-036](http://www.wago.com/769-115/000-036)



**Item no.: 769-115/000-037**  
1-conductor female plug; 4 mm<sup>2</sup>; 15-pole; 4,00 mm<sup>2</sup>; green-yellow, gray

[www.wago.com/769-115/000-037](http://www.wago.com/769-115/000-037)



**Item no.: 769-115/000-038**  
1-conductor female plug; 4 mm<sup>2</sup>; 15-pole; 4,00 mm<sup>2</sup>; gray, blue, green-yellow

[www.wago.com/769-115/000-038](http://www.wago.com/769-115/000-038)



**Item no.: 769-115/000-039**  
1-conductor female plug; 4 mm<sup>2</sup>; 15-pole; 4,00 mm<sup>2</sup>; green-yellow, blue, gray

[www.wago.com/769-115/000-039](http://www.wago.com/769-115/000-039)



**Item no.: 769-115/022-000**  
1-conductor female plug; angled; 4 mm<sup>2</sup>; 15-pole; 4,00 mm<sup>2</sup>; gray

[www.wago.com/769-115/022-000](http://www.wago.com/769-115/022-000)



**Item no.: 769-121**  
2-conductor female connector; 4 mm<sup>2</sup>; 1-pole; 4,00 mm<sup>2</sup>; gray

















[www.wago.com/769-121](http://www.wago.com/769-121)



**Item no.: 769-121/000-016**  
2-conductor female connector; 4 mm<sup>2</sup>; 1-pole; 4,00 mm<sup>2</sup>; green-yellow

[www.wago.com/769-121/000-016](http://www.wago.com/769-121/000-016)

Subject to changes. Please also observe the further product documentation!

	<b>Item no.: 769-122</b> 2-conductor female connector; 4 mm <sup>2</sup> ; 2-pole; 4,00 mm <sup>2</sup> ; gray	<a href="http://www.wago.com/769-122">www.wago.com/769-122</a>
	<b>Item no.: 769-123</b> 2-conductor female connector; 4 mm <sup>2</sup> ; 3-pole; 4,00 mm <sup>2</sup> ; gray	<a href="http://www.wago.com/769-123">www.wago.com/769-123</a>
	<b>Item no.: 769-124</b> 2-conductor female connector; 4 mm <sup>2</sup> ; 4-pole; 4,00 mm <sup>2</sup> ; gray	<a href="http://www.wago.com/769-124">www.wago.com/769-124</a>
	<b>Item no.: 769-125</b> 2-conductor female connector; 4 mm <sup>2</sup> ; 5-pole; 4,00 mm <sup>2</sup> ; gray	<a href="http://www.wago.com/769-125">www.wago.com/769-125</a>
	<b>Item no.: 769-126</b> 2-conductor female connector; 4 mm <sup>2</sup> ; 6-pole; 4,00 mm <sup>2</sup> ; gray	<a href="http://www.wago.com/769-126">www.wago.com/769-126</a>
	<b>Item no.: 769-127</b> 2-conductor female connector; 4 mm <sup>2</sup> ; 7-pole; 4,00 mm <sup>2</sup> ; gray	<a href="http://www.wago.com/769-127">www.wago.com/769-127</a>
	<b>Item no.: 769-128</b> 2-conductor female connector; 4 mm <sup>2</sup> ; 8-pole; 4,00 mm <sup>2</sup> ; gray	<a href="http://www.wago.com/769-128">www.wago.com/769-128</a>
	<b>Item no.: 769-129</b> 2-conductor female connector; 4 mm <sup>2</sup> ; 9-pole; 4,00 mm <sup>2</sup> ; gray	<a href="http://www.wago.com/769-129">www.wago.com/769-129</a>
	<b>Item no.: 769-130</b> 2-conductor female connector; 4 mm <sup>2</sup> ; 10-pole; 4,00 mm <sup>2</sup> ; gray	<a href="http://www.wago.com/769-130">www.wago.com/769-130</a>
	<b>Item no.: 769-131</b> 2-conductor female connector; 4 mm <sup>2</sup> ; 11-pole; 4,00 mm <sup>2</sup> ; gray	<a href="http://www.wago.com/769-131">www.wago.com/769-131</a>
	<b>Item no.: 769-132</b> 2-conductor female connector; 4 mm <sup>2</sup> ; 12-pole; 4,00 mm <sup>2</sup> ; gray	<a href="http://www.wago.com/769-132">www.wago.com/769-132</a>
	<b>Item no.: 769-133</b> 2-conductor female connector; 4 mm <sup>2</sup> ; 13-pole; 4,00 mm <sup>2</sup> ; gray	<a href="http://www.wago.com/769-133">www.wago.com/769-133</a>
	<b>Item no.: 769-134</b> 2-conductor female connector; 4 mm <sup>2</sup> ; 14-pole; 4,00 mm <sup>2</sup> ; gray	<a href="http://www.wago.com/769-134">www.wago.com/769-134</a>
	<b>Item no.: 769-135</b> 2-conductor female connector; 4 mm <sup>2</sup> ; 15-pole; 4,00 mm <sup>2</sup> ; gray	<a href="http://www.wago.com/769-135">www.wago.com/769-135</a>
<b>tools</b>		
	<b>Item no.: 210-720</b> Operating tool; Blade: 3.5 x 0.5 mm; with a partially insulated shaft	<a href="http://www.wago.com/210-720">www.wago.com/210-720</a>
<b>End plate</b>		
	<b>Item no.: 769-307</b> End and intermediate plate; 1.1 mm thick; gray	<a href="http://www.wago.com/769-307">www.wago.com/769-307</a>
	<b>Item no.: 769-308</b> End and intermediate plate; 1.1 mm thick; orange	<a href="http://www.wago.com/769-308">www.wago.com/769-308</a>

Subject to changes. Please also observe the further product documentation!

## Downloads

### Documentation

#### Additional Information

Technical explanations	Apr 3, 2019	pdf 2.1 MB	Download
------------------------	-------------	---------------	----------

## CAD/CAE-Data

### CAD data

2D/3D Models 769-237	URL	Download
----------------------	-----	----------

### CAE data

EPLAN Data Portal 769-237	URL	Download
---------------------------	-----	----------

WSCAD Universe 769-237	URL	Download
------------------------	-----	----------

## Installation Notes

### Assembly

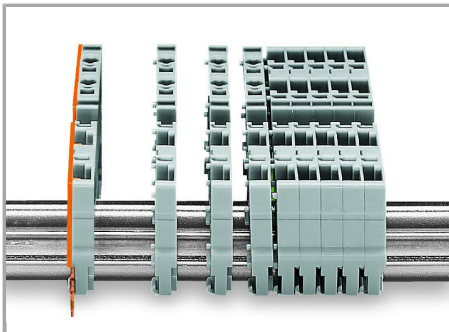

Snap individual carrier terminal blocks onto the carrier rail and slide together.

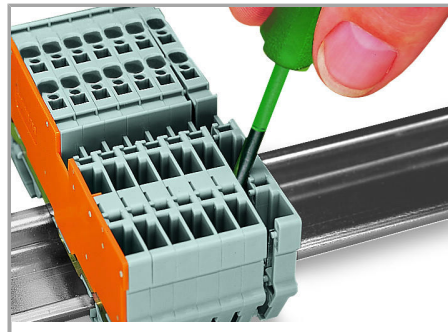

Open the assembly by laterally sliding a block via operating tool and remove terminal block via release lever.

### Inserting a conductor

Subject to changes. Please also observe the further product documentation!

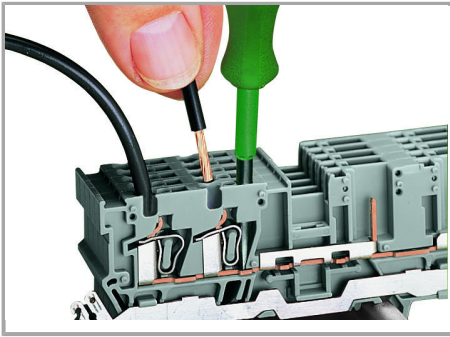

CAGE CLAMP® connection

Carrier terminal block: Insert/remove conductor via operating tool (3.5 x 0.5 mm blade).

#### Jumpered

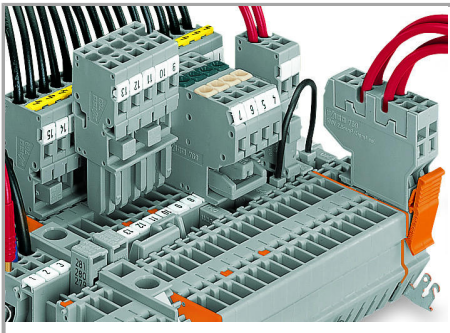

Commoning with adjacent or staggered jumpers –

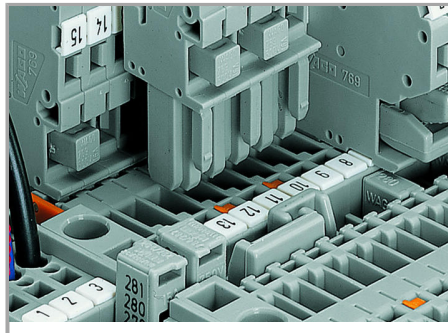

Commoning carrier terminal blocks via staggered jumpers.

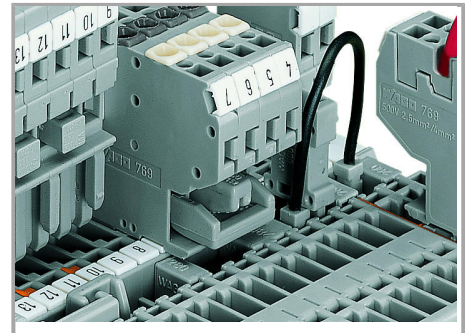

Commoning a 2-conductor female plug via staggered jumper and carrier terminal blocks via adjacent jumpers.

push jumpers down until fully inserted.

Subject to changes. Please also observe the further product documentation!

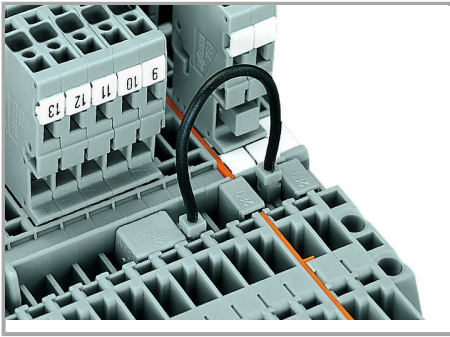

Commoning carrier terminal blocks via push-in type wire jumpers or adjacent jumpers – even over an intermediate plate.

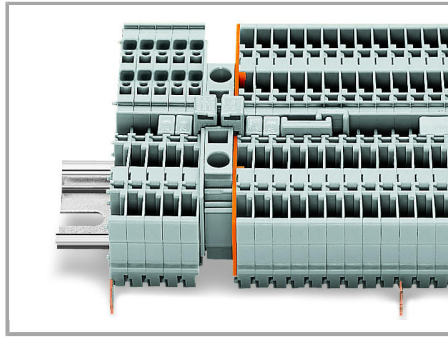

Commoning “supply terminal blocks” (up to 10 mm<sup>2</sup>/8 AWG) with carrier terminal blocks via step-down jumpers.

### Testing

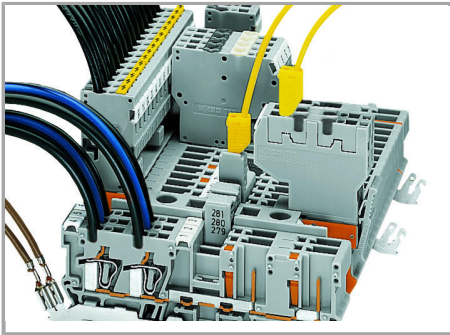

Testing via 2 or 2.3 mm Ø test plugs.

### Coding

Subject to changes. Please also observe the further product documentation!

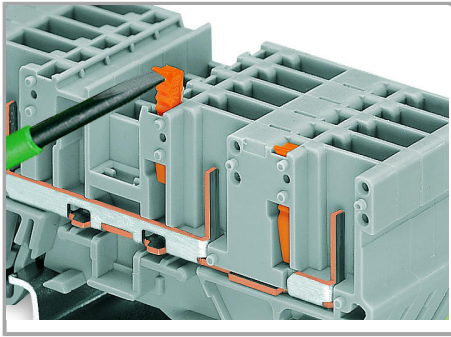

Snap coding pin in proper direction on carrier terminal block.

Shown: Coding pin removal from carrier terminal block.

#### Locking

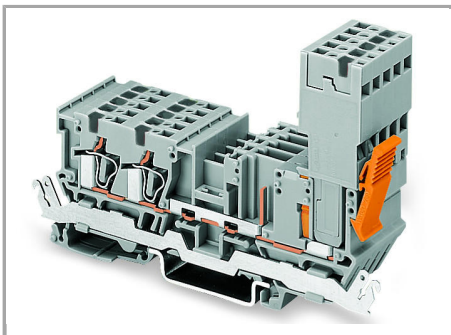

Female plug secured with locking lever on the terminal block side.

Subject to changes. Please also observe the further product documentation!

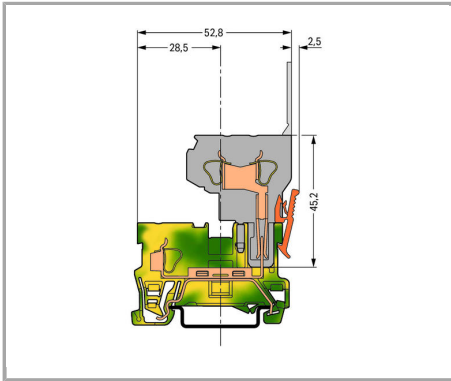

Ground carrier terminal block

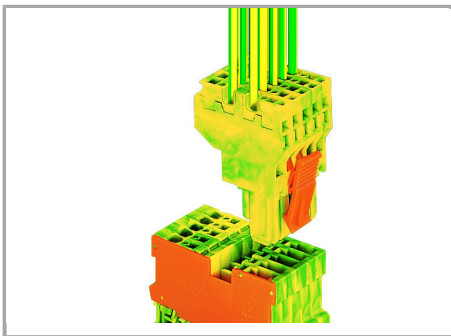

1-conductor/1-pin ground carrier terminal block

2-conductor female plug, green-yellow

## Product family

### X-COM

[Learn more about the product family.](#)

[Show all products from the family](#)

Subject to changes. Please also observe the further product documentation!