

## Data sheet | Item number: 769-232

1-conductor/1-pin disconnect carrier terminal block; for DIN-rail 35 x 15 and 35 x 7.5; 4 mm<sup>2</sup>; CAGE CLAMP®; 4,00 mm<sup>2</sup>; gray

[www.wago.com/769-232](http://www.wago.com/769-232)

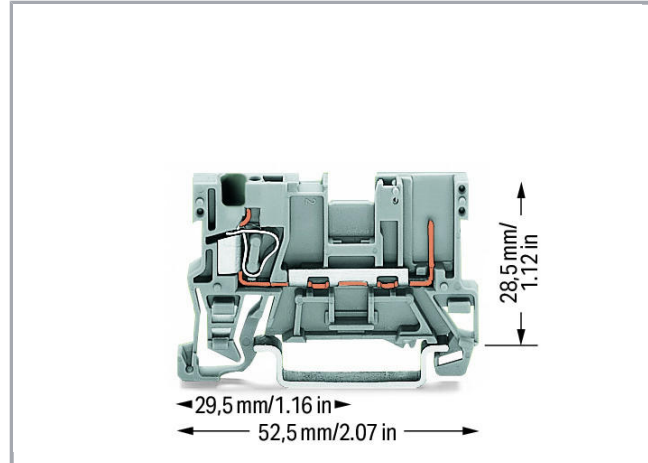
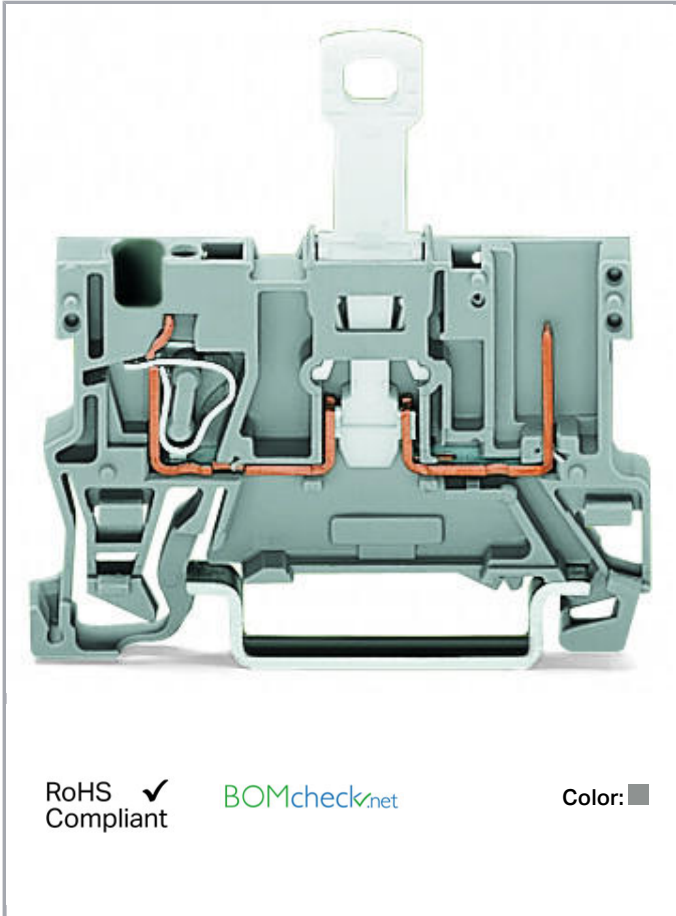

### Data

#### Electrical data

#### Ratings per IEC/EN 60664-1

Rated voltage (III / 3)	400 V
Rated impulse voltage (III / 3)	6 kV
Rated current	16 A
Legend (ratings)	(III / 3) ± Overvoltage category III / Pollution degree 3

Subject to changes. Please also observe the further product documentation!

WAGO Kontakttechnik GmbH & Co. KG  
Hansastr. 27  
32423 Minden  
Phone: +49571 887-0 | Fax: +49571 887-169  
Email: [info.de@wago.com](mailto:info.de@wago.com) | Web: [www.wago.com](http://www.wago.com)

Do you have any questions about our products?  
We are always happy to take your call at +49 (571) 887-44222.



## Connection data

Connection technology	CAGE CLAMP®
Actuation type	Open Tool Slot
Connectable conductor materials	Copper
Nominal cross section	4 mm <sup>2</sup>
Solid conductor	0.08 ... 4 mm <sup>2</sup> / 28 ... 12 AWG
Fine-stranded conductor	0.08 ... 4 mm <sup>2</sup> / 28 ... 12 AWG
Strip length	8 ... 9 mm / 0.31 ... 0.35 inch
Total number of connection points	1
Total number of potentials	1
Number of levels	1
Type of wiring	Front-entry wiring

## Geometrical Data

Width	5 mm / 0.197 inch
Height from upper-edge of DIN-35 rail	28.5 mm / 1.122 inch
Depth	52.5 mm / 2.067 inch

## Mechanical data

Design	horizontal
Type of mounting	DIN-35 rail
Marking level	Center marking

## Material Data

Color	gray
Insulating material	Polyamide 66 (PA 66)
Fire load	0.116 MJ
Weight	5.6 g

## Commercial data

Product Group	18 (X-COM-System)
Packaging type	BOX
Country of origin	DE
GTIN	4045454619497
Customs Tariff No.	85365080900



Subject to changes. Please also observe the further product documentation!

WAGO Kontakttechnik GmbH & Co. KG  
 Hansastr. 27  
 32423 Minden  
 Phone: +49571 887-0 | Fax: +49571 887-169  
 Email: [info.de@wago.com](mailto:info.de@wago.com) | Web: [www.wago.com](http://www.wago.com)



Do you have any questions about our products?  
 We are always happy to take your call at +49 (571) 887-44222.

## Approvals / Certificates

### Country specific Approvals

Logo	Approval	Additional Approval Text	Certificate name
	<b>CCA</b> DEKRA Certification B.V.	EN 60947	NTR NL-7626
	<b>CSA</b> DEKRA Certification B.V.	C22.2 No. 158	1101144
	<b>KEMA/KEUR</b> DEKRA Certification B.V.	EN 60947	2190419.01

### Ship Approvals

Logo	Approval	Additional Approval Text	Certificate name
	<b>ABS</b> American Bureau of Shipping	EN 60947	20-HG1941090-PDA
	<b>DNV GL</b> Det Norske Veritas, Germanischer Lloyd	-	TAE00001V2
	<b>LR</b> Lloyds Register	EN 60947	91/20112 (E9)

### UL-Approvals

Logo	Approval	Additional Approval Text	Certificate name
	<b>UR</b> Underwriters Laboratories Inc.	UL 1059	20190731-E45172
	<b>UR</b> Underwriters Laboratories Inc.	UL 1977	20151210-E45171









Subject to changes. Please also observe the further product documentation!















## Counterpart

## Compatible products

### General accessories

	<b>Item no.: 709-170</b> Disconnect lock; for disconnect tab used on 280/281 and 769 Series disconnect terminal blocks; red	<a href="http://www.wago.com/709-170">www.wago.com/709-170</a>
	<b>Item no.: 769-438</b> Pin cover; with marker slot for miniature WSB; gray	<a href="http://www.wago.com/769-438">www.wago.com/769-438</a>
	<b>Item no.: 769-439</b> Pin cover; with marker slot for miniature WSB; orange	<a href="http://www.wago.com/769-439">www.wago.com/769-439</a>
	<b>Item no.: 769-501</b> Start module for 1-conductor female connector; with integrated end plate; 4 mm <sup>2</sup> ; 1-pole; 4,00 mm <sup>2</sup> ; gray	<a href="http://www.wago.com/769-501">www.wago.com/769-501</a>
	<b>Item no.: 769-501/000-006</b> Start module for 1-conductor female connector; 4 mm <sup>2</sup> ; 1-pole; 4,00 mm <sup>2</sup> ; blue	<a href="http://www.wago.com/769-501/000-006">www.wago.com/769-501/000-006</a>
	<b>Item no.: 769-501/000-016</b> Start module for 1-conductor female connector; with integrated end plate; 4 mm <sup>2</sup> ; 1-pole; 4,00 mm <sup>2</sup> ; green-yellow	<a href="http://www.wago.com/769-501/000-016">www.wago.com/769-501/000-016</a>
	<b>Item no.: 769-502</b> Center module for 1-conductor female connector; 4 mm <sup>2</sup> ; 1-pole; 4,00 mm <sup>2</sup> ; gray	<a href="http://www.wago.com/769-502">www.wago.com/769-502</a>
	<b>Item no.: 769-502/000-006</b> Center module for 1-conductor female connector; 4 mm <sup>2</sup> ; 1-pole; 4,00 mm <sup>2</sup> ; blue	<a href="http://www.wago.com/769-502/000-006">www.wago.com/769-502/000-006</a>

Subject to changes. Please also observe the further product documentation!

	<b>Item no.: 769-502/000-016</b> Center module for 1-conductor female connector; 4 mm <sup>2</sup> ; 1-pole; 4,00 mm <sup>2</sup> ; green-yellow	<a href="http://www.wago.com/769-502/000-016">www.wago.com/769-502/000-016</a>
	<b>Item no.: 769-503</b> End module for 1-conductor female connector; 4 mm <sup>2</sup> ; 1-pole; 4,00 mm <sup>2</sup> ; gray	<a href="http://www.wago.com/769-503">www.wago.com/769-503</a>
	<b>Item no.: 769-503/000-006</b> End module for 1-conductor female connector; 4 mm <sup>2</sup> ; 1-pole; 4,00 mm <sup>2</sup> ; blue	<a href="http://www.wago.com/769-503/000-006">www.wago.com/769-503/000-006</a>
	<b>Item no.: 769-503/000-016</b> End module for 1-conductor female connector; 4 mm <sup>2</sup> ; 1-pole; 4,00 mm <sup>2</sup> ; green-yellow	<a href="http://www.wago.com/769-503/000-016">www.wago.com/769-503/000-016</a>
	<b>Item no.: 769-504</b> Start module for 2-conductor female connector; with integrated end plate; 4 mm <sup>2</sup> ; 1-pole; 4,00 mm <sup>2</sup> ; gray	<a href="http://www.wago.com/769-504">www.wago.com/769-504</a>
	<b>Item no.: 769-504/000-006</b> Start module for 2-conductor female connector; with integrated end plate; 4 mm <sup>2</sup> ; 1-pole; 4,00 mm <sup>2</sup> ; blue	<a href="http://www.wago.com/769-504/000-006">www.wago.com/769-504/000-006</a>
	<b>Item no.: 769-504/000-016</b> Start module for 2-conductor female connector; 4 mm <sup>2</sup> ; 1-pole; 4,00 mm <sup>2</sup> ; green-yellow	<a href="http://www.wago.com/769-504/000-016">www.wago.com/769-504/000-016</a>
	<b>Item no.: 769-505</b> Center module for 2-conductor female connector; 4 mm <sup>2</sup> ; 1-pole; 4,00 mm <sup>2</sup> ; gray	<a href="http://www.wago.com/769-505">www.wago.com/769-505</a>
	<b>Item no.: 769-505/000-006</b> Center module for 2-conductor female connector; 4 mm <sup>2</sup> ; 1-pole; 4,00 mm <sup>2</sup> ; blue	<a href="http://www.wago.com/769-505/000-006">www.wago.com/769-505/000-006</a>
	<b>Item no.: 769-505/000-016</b> Center module for 2-conductor female connector; 4 mm <sup>2</sup> ; 1-pole; 4,00 mm <sup>2</sup> ; green-yellow	<a href="http://www.wago.com/769-505/000-016">www.wago.com/769-505/000-016</a>
	<b>Item no.: 769-506</b> End module for 2-conductor female connector; 4 mm <sup>2</sup> ; 1-pole; 4,00 mm <sup>2</sup> ; gray	<a href="http://www.wago.com/769-506">www.wago.com/769-506</a>
	<b>Item no.: 769-506/000-006</b> End module for 2-conductor female connector; 4 mm <sup>2</sup> ; 1-pole; 4,00 mm <sup>2</sup> ; blue	<a href="http://www.wago.com/769-506/000-006">www.wago.com/769-506/000-006</a>
	<b>Item no.: 769-506/000-016</b> End module for 2-conductor female connector; 4 mm <sup>2</sup> ; 1-pole; 4,00 mm <sup>2</sup> ; green-yellow	<a href="http://www.wago.com/769-506/000-016">www.wago.com/769-506/000-016</a>
	<b>Item no.: 769-512</b> Start module for 1-conductor female connector; angled; 4 mm <sup>2</sup> ; 1-pole; 4,00 mm <sup>2</sup> ; gray	<a href="http://www.wago.com/769-512">www.wago.com/769-512</a>

Subject to changes. Please also observe the further product documentation!



**Item no.: 769-512/000-006**

Start module for 1-conductor female connector; angled; 4 mm<sup>2</sup>; 1-pole; 4,00 mm<sup>2</sup>; blue

[www.wago.com/769-512/000-006](http://www.wago.com/769-512/000-006)

**Item no.: 769-512/000-016**

Start module for 1-conductor female connector; angled; 4 mm<sup>2</sup>; 1-pole; 4,00 mm<sup>2</sup>; green-yellow

[www.wago.com/769-512/000-016](http://www.wago.com/769-512/000-016)



**Item no.: 769-513**

Center module for 1-conductor female connector; angled; 4 mm<sup>2</sup>; 1-pole; 4,00 mm<sup>2</sup>; gray

[www.wago.com/769-513](http://www.wago.com/769-513)



**Item no.: 769-513/000-006**

Center module for 1-conductor female connector; angled; 4 mm<sup>2</sup>; 1-pole; 4,00 mm<sup>2</sup>; blue

[www.wago.com/769-513/000-006](http://www.wago.com/769-513/000-006)



**Item no.: 769-513/000-016**

Center module for 1-conductor female connector; angled; 4 mm<sup>2</sup>; 1-pole; 4,00 mm<sup>2</sup>; green-yellow

[www.wago.com/769-513/000-016](http://www.wago.com/769-513/000-016)



**Item no.: 769-515**

End module for 1-conductor female connector; angled; 4 mm<sup>2</sup>; 1-pole; 4,00 mm<sup>2</sup>; gray

[www.wago.com/769-515](http://www.wago.com/769-515)



**Item no.: 769-515/000-006**

End module for 1-conductor female connector; angled; 4 mm<sup>2</sup>; 1-pole; 4,00 mm<sup>2</sup>; blue

[www.wago.com/769-515/000-006](http://www.wago.com/769-515/000-006)



**Item no.: 769-515/000-016**

End module for 1-conductor female connector; angled; 4 mm<sup>2</sup>; 1-pole; 4,00 mm<sup>2</sup>; green-yellow

[www.wago.com/769-515/000-016](http://www.wago.com/769-515/000-016)

**Insulation stop**



**Item no.: 769-470**

Insulation stop; 0.08 - 0.2 mm<sup>2</sup> "s" (0.14 mm<sup>2</sup> "f-st"); 5 pieces/strip; white

[www.wago.com/769-470](http://www.wago.com/769-470)



**Item no.: 769-471**

Insulation stop; 0.25 - 0.5 mm<sup>2</sup>; 5 pieces/strip; light gray

[www.wago.com/769-471](http://www.wago.com/769-471)

**Item no.: 769-472**

Insulation stop; 0.75 - 1 mm<sup>2</sup>; 5 pieces/strip; dark gray

[www.wago.com/769-472](http://www.wago.com/769-472)

**Jumper**



**Item no.: 249-123**

Push-in type wire jumper; insulated; wire length 180 mm; Conductor cross section 0.75 mm<sup>2</sup>

[www.wago.com/249-123](http://www.wago.com/249-123)



**Item no.: 249-125**

Push-in type wire jumper; insulated; wire length 60 mm; Conductor cross section 0.75 mm<sup>2</sup>

[www.wago.com/249-125](http://www.wago.com/249-125)



**Item no.: 249-126**

Push-in type wire jumper; insulated; wire length 110 mm; Conductor cross section 0.75 mm<sup>2</sup>

[www.wago.com/249-126](http://www.wago.com/249-126)



**Item no.: 249-127**

Push-in type wire jumper; insulated; wire length 250 mm; Conductor cross section 0.75 mm<sup>2</sup>

[www.wago.com/249-127](http://www.wago.com/249-127)

Subject to changes. Please also observe the further product documentation!

WAGO Kontakttechnik GmbH & Co. KG

Hansastr. 27

32423 Minden

Phone: +49571 887-0 | Fax: +49571 887-169

Email: [info.de@wago.com](mailto:info.de@wago.com) | Web: [www.wago.com](http://www.wago.com)

Do you have any questions about our products?

We are always happy to take your call at +49 (571) 887-44222.

## Coding

**Item no.: 769-435**

Coding pin; for coding of female plugs; for carrier terminal blocks / male connectors; orange

[www.wago.com/769-435](http://www.wago.com/769-435)

## assembling

**Item no.: 209-106**

Mounting carrier; for isolated mounting on DIN 35 rails; gray

[www.wago.com/209-106](http://www.wago.com/209-106)

## Carrier rail

**Item no.: 210-112**

Steel carrier rail; 35 x 7.5 mm; 1 mm thick; 2 m long; slotted; according to EN 60715; "Hole width 25 mm

[www.wago.com/210-112](http://www.wago.com/210-112)**Item no.: 210-113**

Steel carrier rail; 35 x 7.5 mm; 1 mm thick; 2 m long; unslotted; according to EN 60715

[www.wago.com/210-113](http://www.wago.com/210-113)**Item no.: 210-114**

Steel carrier rail; 35 x 15 mm; 1.5 mm thick; 2 m long; unslotted; similar to EN 60715

[www.wago.com/210-114](http://www.wago.com/210-114)**Item no.: 210-115**

Steel carrier rail; 35 x 7.5 mm; 1 mm thick; 2 m long; slotted; according to EN 60715; "Hole width 18 mm

[www.wago.com/210-115](http://www.wago.com/210-115)**Item no.: 210-118**

Steel carrier rail; 35 x 15 mm; 2.3 mm thick; 2 m long; unslotted; according to EN 60715

[www.wago.com/210-118](http://www.wago.com/210-118)**Item no.: 210-196**

Aluminum carrier rail; 35 x 8.2 mm; 1.6 mm thick; 2 m long; unslotted; similar to EN 60715; silver-colored

[www.wago.com/210-196](http://www.wago.com/210-196)**Item no.: 210-197**

Steel carrier rail; 35 x 15 mm; 1.5 mm thick; 2 m long; slotted; similar to EN 60715

[www.wago.com/210-197](http://www.wago.com/210-197)**Item no.: 210-198**

Copper carrier rail; 35 x 15 mm; 2.3 mm thick; 2 m long; unslotted; according to EN 60715; copper-colored

[www.wago.com/210-198](http://www.wago.com/210-198)**Item no.: 210-504**

Steel carrier rail; 35 x 7.5 mm; 1 mm thick; 2 m long; slotted; galvanized; according to EN 60715

[www.wago.com/210-504](http://www.wago.com/210-504)**Item no.: 210-505**

Steel carrier rail; 35 x 7.5 mm; 1 mm thick; 2 m long; unslotted; galvanized; according to EN 60715

[www.wago.com/210-505](http://www.wago.com/210-505)**Item no.: 210-506**

Steel carrier rail; 35 x 15 mm; 1.5 mm thick; 2 m long; unslotted; galvanized; similar to EN 60715

[www.wago.com/210-506](http://www.wago.com/210-506)**Item no.: 210-508**

Steel carrier rail; 35 x 15 mm; 1.5 mm thick; 2 m long; slotted; galvanized; similar to EN 60715

[www.wago.com/210-508](http://www.wago.com/210-508)

## Female plug

**Item no.: 769-101**1-conductor female plug; 4 mm<sup>2</sup>; 1-pole; 4,00 mm<sup>2</sup>; gray[www.wago.com/769-101](http://www.wago.com/769-101)**Item no.: 769-101/000-006**1-conductor female plug; 4 mm<sup>2</sup>; 1-pole; 4,00 mm<sup>2</sup>; blue[www.wago.com/769-101/000-006](http://www.wago.com/769-101/000-006)

Subject to changes. Please also observe the further product documentation!

WAGO Kontakttechnik GmbH &amp; Co. KG

Hansastr. 27











32423 Minden

Phone: +49571 887-0 | Fax: +49571 887-169

Email: [info.de@wago.com](mailto:info.de@wago.com) | Web: [www.wago.com](http://www.wago.com)

Do you have any questions about our products?

We are always happy to take your call at +49 (571) 887-44222.

	<b>Item no.: 769-101/000-016</b> 1-conductor female plug; 4 mm <sup>2</sup> ; 1-pole; 4,00 mm <sup>2</sup> ; green-yellow	<a href="http://www.wago.com/769-101/000-016">www.wago.com/769-101/000-016</a>
	<b>Item no.: 769-101/022-000</b> 1-conductor female plug; angled; 4 mm <sup>2</sup> ; 1-pole; 4,00 mm <sup>2</sup> ; gray	<a href="http://www.wago.com/769-101/022-000">www.wago.com/769-101/022-000</a>
	<b>Item no.: 769-101/022-016</b> 1-conductor female plug; angled; 4 mm <sup>2</sup> ; 1-pole; 4,00 mm <sup>2</sup> ; green-yellow	<a href="http://www.wago.com/769-101/022-016">www.wago.com/769-101/022-016</a>
	<b>Item no.: 769-102</b> 1-conductor female plug; 4 mm <sup>2</sup> ; 2-pole; 4,00 mm <sup>2</sup> ; gray	<a href="http://www.wago.com/769-102">www.wago.com/769-102</a>
	<b>Item no.: 769-102/000-006</b> 1-conductor female plug; 4 mm <sup>2</sup> ; 2-pole; 4,00 mm <sup>2</sup> ; blue	<a href="http://www.wago.com/769-102/000-006">www.wago.com/769-102/000-006</a>
	<b>Item no.: 769-102/000-036</b> 1-conductor female plug; 4 mm <sup>2</sup> ; 2-pole; 4,00 mm <sup>2</sup> ; gray, green-yellow	<a href="http://www.wago.com/769-102/000-036">www.wago.com/769-102/000-036</a>
	<b>Item no.: 769-102/000-037</b> 1-conductor female plug; 4 mm <sup>2</sup> ; 2-pole; 4,00 mm <sup>2</sup> ; green-yellow, gray	<a href="http://www.wago.com/769-102/000-037">www.wago.com/769-102/000-037</a>
	<b>Item no.: 769-102/022-000</b> 1-conductor female plug; angled; 4 mm <sup>2</sup> ; 2-pole; 4,00 mm <sup>2</sup> ; gray	<a href="http://www.wago.com/769-102/022-000">www.wago.com/769-102/022-000</a>
	<b>Item no.: 769-103</b> 1-conductor female plug; 4 mm <sup>2</sup> ; 3-pole; 4,00 mm <sup>2</sup> ; gray	<a href="http://www.wago.com/769-103">www.wago.com/769-103</a>
	<b>Item no.: 769-103/000-006</b> 1-conductor female plug; 4 mm <sup>2</sup> ; 3-pole; 4,00 mm <sup>2</sup> ; blue	<a href="http://www.wago.com/769-103/000-006">www.wago.com/769-103/000-006</a>
	<b>Item no.: 769-103/000-036</b> 1-conductor female plug; 4 mm <sup>2</sup> ; 3-pole; 4,00 mm <sup>2</sup> ; gray, green-yellow	<a href="http://www.wago.com/769-103/000-036">www.wago.com/769-103/000-036</a>
	<b>Item no.: 769-103/000-037</b> 1-conductor female plug; 4 mm <sup>2</sup> ; 3-pole; 4,00 mm <sup>2</sup> ; green-yellow, gray	<a href="http://www.wago.com/769-103/000-037">www.wago.com/769-103/000-037</a>
	<b>Item no.: 769-103/000-038</b> 1-conductor female plug; 4 mm <sup>2</sup> ; 3-pole; 4,00 mm <sup>2</sup> ; gray, blue, green-yellow	<a href="http://www.wago.com/769-103/000-038">www.wago.com/769-103/000-038</a>
	<b>Item no.: 769-103/000-039</b> 1-conductor female plug; 4 mm <sup>2</sup> ; 3-pole; 4,00 mm <sup>2</sup> ; green-yellow, blue, gray	<a href="http://www.wago.com/769-103/000-039">www.wago.com/769-103/000-039</a>

Subject to changes. Please also observe the further product documentation!



**Item no.: 769-103/022-000**

1-conductor female plug; angled; 4 mm<sup>2</sup>; 3-pole; 4,00 mm<sup>2</sup>; gray

[www.wago.com/769-103/022-000](http://www.wago.com/769-103/022-000)



**Item no.: 769-104**

1-conductor female plug; 4 mm<sup>2</sup>; 4-pole; 4,00 mm<sup>2</sup>; gray

[www.wago.com/769-104](http://www.wago.com/769-104)



**Item no.: 769-104/000-006**

1-conductor female plug; 4 mm<sup>2</sup>; 4-pole; 4,00 mm<sup>2</sup>; blue

[www.wago.com/769-104/000-006](http://www.wago.com/769-104/000-006)



**Item no.: 769-104/000-036**

1-conductor female plug; 4 mm<sup>2</sup>; 4-pole; 4,00 mm<sup>2</sup>; gray, green-yellow

[www.wago.com/769-104/000-036](http://www.wago.com/769-104/000-036)



**Item no.: 769-104/000-037**

1-conductor female plug; 4 mm<sup>2</sup>; 4-pole; 4,00 mm<sup>2</sup>; green-yellow, gray

[www.wago.com/769-104/000-037](http://www.wago.com/769-104/000-037)

**Item no.: 769-104/000-038**

1-conductor female plug; 4 mm<sup>2</sup>; 4-pole; 4,00 mm<sup>2</sup>; gray, blue, green-yellow

[www.wago.com/769-104/000-038](http://www.wago.com/769-104/000-038)

**Item no.: 769-104/000-039**

1-conductor female plug; 4 mm<sup>2</sup>; 4-pole; 4,00 mm<sup>2</sup>; green-yellow, blue, gray

[www.wago.com/769-104/000-039](http://www.wago.com/769-104/000-039)

**Item no.: 769-104/022-000**

1-conductor female plug; angled; 4 mm<sup>2</sup>; 4-pole; 4,00 mm<sup>2</sup>; gray

[www.wago.com/769-104/022-000](http://www.wago.com/769-104/022-000)



**Item no.: 769-105**

1-conductor female plug; 4 mm<sup>2</sup>; 5-pole; 4,00 mm<sup>2</sup>; gray

[www.wago.com/769-105](http://www.wago.com/769-105)



**Item no.: 769-105/000-006**

1-conductor female plug; 4 mm<sup>2</sup>; 5-pole; 4,00 mm<sup>2</sup>; blue

[www.wago.com/769-105/000-006](http://www.wago.com/769-105/000-006)



**Item no.: 769-105/000-036**

1-conductor female plug; 4 mm<sup>2</sup>; 5-pole; 4,00 mm<sup>2</sup>; gray, green-yellow

[www.wago.com/769-105/000-036](http://www.wago.com/769-105/000-036)

**Item no.: 769-105/000-037**

1-conductor female plug; 4 mm<sup>2</sup>; 5-pole; 4,00 mm<sup>2</sup>; green-yellow, gray

[www.wago.com/769-105/000-037](http://www.wago.com/769-105/000-037)



**Item no.: 769-105/000-038**

1-conductor female plug; 4 mm<sup>2</sup>; 5-pole; 4,00 mm<sup>2</sup>; gray, blue, green-yellow

[www.wago.com/769-105/000-038](http://www.wago.com/769-105/000-038)



**Item no.: 769-105/000-039**

1-conductor female plug; 4 mm<sup>2</sup>; 5-pole; 4,00 mm<sup>2</sup>; green-yellow, blue, gray

[www.wago.com/769-105/000-039](http://www.wago.com/769-105/000-039)

Subject to changes. Please also observe the further product documentation!

WAGO Kontakttechnik GmbH & Co. KG

Hansastr. 27

32423 Minden

Phone: +49571 887-0 | Fax: +49571 887-169

Email: [info.de@wago.com](mailto:info.de@wago.com) | Web: [www.wago.com](http://www.wago.com)

Do you have any questions about our products?

We are always happy to take your call at +49 (571) 887-44222.



**Item no.: 769-105/022-000**  
1-conductor female plug; angled; 4 mm<sup>2</sup>; 5-pole; 4,00 mm<sup>2</sup>; gray

[www.wago.com/769-105/022-000](http://www.wago.com/769-105/022-000)

**Item no.: 769-106**  
1-conductor female plug; 4 mm<sup>2</sup>; 6-pole; 4,00 mm<sup>2</sup>; gray

[www.wago.com/769-106](http://www.wago.com/769-106)



**Item no.: 769-106/000-006**  
1-conductor female plug; 4 mm<sup>2</sup>; 6-pole; 4,00 mm<sup>2</sup>; blue

[www.wago.com/769-106/000-006](http://www.wago.com/769-106/000-006)



**Item no.: 769-106/000-036**  
1-conductor female plug; 4 mm<sup>2</sup>; 6-pole; 4,00 mm<sup>2</sup>; gray, green-yellow

[www.wago.com/769-106/000-036](http://www.wago.com/769-106/000-036)

**Item no.: 769-106/000-037**  
1-conductor female plug; 4 mm<sup>2</sup>; 6-pole; 4,00 mm<sup>2</sup>; green-yellow, gray

[www.wago.com/769-106/000-037](http://www.wago.com/769-106/000-037)

**Item no.: 769-106/000-038**  
1-conductor female plug; 4 mm<sup>2</sup>; 6-pole; 4,00 mm<sup>2</sup>; gray, blue, green-yellow

[www.wago.com/769-106/000-038](http://www.wago.com/769-106/000-038)

**Item no.: 769-106/000-039**  
1-conductor female plug; 4 mm<sup>2</sup>; 6-pole; 4,00 mm<sup>2</sup>; green-yellow, blue, gray

[www.wago.com/769-106/000-039](http://www.wago.com/769-106/000-039)



**Item no.: 769-106/022-000**  
1-conductor female plug; angled; 4 mm<sup>2</sup>; 6-pole; 4,00 mm<sup>2</sup>; gray

[www.wago.com/769-106/022-000](http://www.wago.com/769-106/022-000)



**Item no.: 769-107**  
1-conductor female plug; 4 mm<sup>2</sup>; 7-pole; 4,00 mm<sup>2</sup>; gray

[www.wago.com/769-107](http://www.wago.com/769-107)

**Item no.: 769-107/000-006**  
1-conductor female plug; 4 mm<sup>2</sup>; 7-pole; 4,00 mm<sup>2</sup>; blue

[www.wago.com/769-107/000-006](http://www.wago.com/769-107/000-006)



**Item no.: 769-107/000-036**  
1-conductor female plug; 4 mm<sup>2</sup>; 7-pole; 4,00 mm<sup>2</sup>; gray, green-yellow

[www.wago.com/769-107/000-036](http://www.wago.com/769-107/000-036)



**Item no.: 769-107/000-037**  
1-conductor female plug; 4 mm<sup>2</sup>; 7-pole; 4,00 mm<sup>2</sup>; green-yellow, gray

[www.wago.com/769-107/000-037](http://www.wago.com/769-107/000-037)

**Item no.: 769-107/000-038**  
1-conductor female plug; 4 mm<sup>2</sup>; 7-pole; 4,00 mm<sup>2</sup>; gray, blue, green-yellow

[www.wago.com/769-107/000-038](http://www.wago.com/769-107/000-038)

**Item no.: 769-107/000-039**  
1-conductor female plug; 4 mm<sup>2</sup>; 7-pole; 4,00 mm<sup>2</sup>; green-yellow, blue, gray

[www.wago.com/769-107/000-039](http://www.wago.com/769-107/000-039)

Subject to changes. Please also observe the further product documentation!

**Item no.: 769-107/022-000**

1-conductor female plug; angled; 4 mm<sup>2</sup>; 7-pole; 4,00 mm<sup>2</sup>; gray

[www.wago.com/769-107/022-000](http://www.wago.com/769-107/022-000)



**Item no.: 769-108**

1-conductor female plug; 4 mm<sup>2</sup>; 8-pole; 4,00 mm<sup>2</sup>; gray

[www.wago.com/769-108](http://www.wago.com/769-108)



**Item no.: 769-108/000-006**

1-conductor female plug; 4 mm<sup>2</sup>; 8-pole; 4,00 mm<sup>2</sup>; blue

[www.wago.com/769-108/000-006](http://www.wago.com/769-108/000-006)



**Item no.: 769-108/000-036**

1-conductor female plug; 4 mm<sup>2</sup>; 8-pole; 4,00 mm<sup>2</sup>; gray, green-yellow

[www.wago.com/769-108/000-036](http://www.wago.com/769-108/000-036)



**Item no.: 769-108/000-037**

1-conductor female plug; 4 mm<sup>2</sup>; 8-pole; 4,00 mm<sup>2</sup>; green-yellow, gray

[www.wago.com/769-108/000-037](http://www.wago.com/769-108/000-037)



**Item no.: 769-108/000-038**

1-conductor female plug; 4 mm<sup>2</sup>; 8-pole; 4,00 mm<sup>2</sup>; gray, blue, green-yellow

[www.wago.com/769-108/000-038](http://www.wago.com/769-108/000-038)



**Item no.: 769-108/000-039**

1-conductor female plug; 4 mm<sup>2</sup>; 8-pole; 4,00 mm<sup>2</sup>; green-yellow, blue, gray

[www.wago.com/769-108/000-039](http://www.wago.com/769-108/000-039)



**Item no.: 769-108/022-000**

1-conductor female plug; angled; 4 mm<sup>2</sup>; 8-pole; 4,00 mm<sup>2</sup>; gray

[www.wago.com/769-108/022-000](http://www.wago.com/769-108/022-000)



**Item no.: 769-109**

1-conductor female plug; 4 mm<sup>2</sup>; 9-pole; 4,00 mm<sup>2</sup>; gray

[www.wago.com/769-109](http://www.wago.com/769-109)



**Item no.: 769-109/000-006**

1-conductor female plug; 4 mm<sup>2</sup>; 9-pole; 4,00 mm<sup>2</sup>; blue

[www.wago.com/769-109/000-006](http://www.wago.com/769-109/000-006)



**Item no.: 769-109/000-036**

1-conductor female plug; 4 mm<sup>2</sup>; 9-pole; 4,00 mm<sup>2</sup>; gray, green-yellow

[www.wago.com/769-109/000-036](http://www.wago.com/769-109/000-036)



**Item no.: 769-109/000-037**

1-conductor female plug; 4 mm<sup>2</sup>; 9-pole; 4,00 mm<sup>2</sup>; green-yellow, gray

[www.wago.com/769-109/000-037](http://www.wago.com/769-109/000-037)



**Item no.: 769-109/000-038**

1-conductor female plug; 4 mm<sup>2</sup>; 9-pole; 4,00 mm<sup>2</sup>; gray, blue, green-yellow

[www.wago.com/769-109/000-038](http://www.wago.com/769-109/000-038)



**Item no.: 769-109/000-039**

1-conductor female plug; 4 mm<sup>2</sup>; 9-pole; 4,00 mm<sup>2</sup>; green-yellow, blue, gray

[www.wago.com/769-109/000-039](http://www.wago.com/769-109/000-039)

Subject to changes. Please also observe the further product documentation!

WAGO Kontakttechnik GmbH & Co. KG

Hansastr. 27

32423 Minden

Phone: +49571 887-0 | Fax: +49571 887-169

Email: [info.de@wago.com](mailto:info.de@wago.com) | Web: [www.wago.com](http://www.wago.com)

Do you have any questions about our products?

We are always happy to take your call at +49 (571) 887-44222.



**Item no.: 769-109/022-000**  
1-conductor female plug; angled; 4 mm<sup>2</sup>; 9-pole; 4,00 mm<sup>2</sup>; gray

[www.wago.com/769-109/022-000](http://www.wago.com/769-109/022-000)



**Item no.: 769-110**  
1-conductor female plug; 4 mm<sup>2</sup>; 10-pole; 4,00 mm<sup>2</sup>; gray

[www.wago.com/769-110](http://www.wago.com/769-110)



**Item no.: 769-110/000-006**  
1-conductor female plug; 4 mm<sup>2</sup>; 10-pole; 4,00 mm<sup>2</sup>; blue

[www.wago.com/769-110/000-006](http://www.wago.com/769-110/000-006)



**Item no.: 769-110/000-036**  
1-conductor female plug; 4 mm<sup>2</sup>; 10-pole; 4,00 mm<sup>2</sup>; gray, green-yellow

[www.wago.com/769-110/000-036](http://www.wago.com/769-110/000-036)



**Item no.: 769-110/000-037**  
1-conductor female plug; 4 mm<sup>2</sup>; 10-pole; 4,00 mm<sup>2</sup>; green-yellow, gray

[www.wago.com/769-110/000-037](http://www.wago.com/769-110/000-037)



**Item no.: 769-110/000-038**  
1-conductor female plug; 4 mm<sup>2</sup>; 10-pole; 4,00 mm<sup>2</sup>; gray, blue, green-yellow

[www.wago.com/769-110/000-038](http://www.wago.com/769-110/000-038)



**Item no.: 769-110/000-039**  
1-conductor female plug; 4 mm<sup>2</sup>; 10-pole; 4,00 mm<sup>2</sup>; green-yellow, blue, gray

[www.wago.com/769-110/000-039](http://www.wago.com/769-110/000-039)



**Item no.: 769-110/022-000**  
1-conductor female plug; angled; 4 mm<sup>2</sup>; 10-pole; 4,00 mm<sup>2</sup>; gray

[www.wago.com/769-110/022-000](http://www.wago.com/769-110/022-000)



**Item no.: 769-111**  
1-conductor female plug; 4 mm<sup>2</sup>; 11-pole; 4,00 mm<sup>2</sup>; gray

[www.wago.com/769-111](http://www.wago.com/769-111)



**Item no.: 769-111/000-006**  
1-conductor female plug; 4 mm<sup>2</sup>; 11-pole; 4,00 mm<sup>2</sup>; blue

[www.wago.com/769-111/000-006](http://www.wago.com/769-111/000-006)



**Item no.: 769-111/000-036**  
1-conductor female plug; 4 mm<sup>2</sup>; 11-pole; 4,00 mm<sup>2</sup>; gray, green-yellow

[www.wago.com/769-111/000-036](http://www.wago.com/769-111/000-036)



**Item no.: 769-111/000-037**  
1-conductor female plug; 4 mm<sup>2</sup>; 11-pole; 4,00 mm<sup>2</sup>; green-yellow, gray

[www.wago.com/769-111/000-037](http://www.wago.com/769-111/000-037)



**Item no.: 769-111/000-038**  
1-conductor female plug; 4 mm<sup>2</sup>; 11-pole; 4,00 mm<sup>2</sup>; gray, blue, green-yellow















[www.wago.com/769-111/000-038](http://www.wago.com/769-111/000-038)

















**Item no.: 769-111/000-039**  
1-conductor female plug; 4 mm<sup>2</sup>; 11-pole; 4,00 mm<sup>2</sup>; green-yellow, blue, gray

[www.wago.com/769-111/000-039](http://www.wago.com/769-111/000-039)

Subject to changes. Please also observe the further product documentation!

	<b>Item no.: 769-111/022-000</b> 1-conductor female plug; angled; 4 mm²; 11-pole; 4,00 mm²; gray	<a href="http://www.wago.com/769-111/022-000">www.wago.com/769-111/022-000</a>
	<b>Item no.: 769-112</b> 1-conductor female plug; 4 mm²; 12-pole; 4,00 mm²; gray	<a href="http://www.wago.com/769-112">www.wago.com/769-112</a>
	<b>Item no.: 769-112/000-006</b> 1-conductor female plug; 4 mm²; 12-pole; 4,00 mm²; blue	<a href="http://www.wago.com/769-112/000-006">www.wago.com/769-112/000-006</a>
	<b>Item no.: 769-112/000-036</b> 1-conductor female plug; 4 mm²; 12-pole; 4,00 mm²; gray, green-yellow	<a href="http://www.wago.com/769-112/000-036">www.wago.com/769-112/000-036</a>
	<b>Item no.: 769-112/000-037</b> 1-conductor female plug; 4 mm²; 12-pole; 4,00 mm²; green-yellow, gray	<a href="http://www.wago.com/769-112/000-037">www.wago.com/769-112/000-037</a>
	<b>Item no.: 769-112/000-038</b> 1-conductor female plug; 4 mm²; 12-pole; 4,00 mm²; gray, blue, green-yellow	<a href="http://www.wago.com/769-112/000-038">www.wago.com/769-112/000-038</a>
	<b>Item no.: 769-112/000-039</b> 1-conductor female plug; 4 mm²; 12-pole; 4,00 mm²; green-yellow, blue, gray	<a href="http://www.wago.com/769-112/000-039">www.wago.com/769-112/000-039</a>
	<b>Item no.: 769-112/022-000</b> 1-conductor female plug; angled; 4 mm²; 12-pole; 4,00 mm²; gray	<a href="http://www.wago.com/769-112/022-000">www.wago.com/769-112/022-000</a>
	<b>Item no.: 769-113</b> 1-conductor female plug; 4 mm²; 13-pole; 4,00 mm²; gray	<a href="http://www.wago.com/769-113">www.wago.com/769-113</a>
	<b>Item no.: 769-113/000-036</b> 1-conductor female plug; 4 mm²; 13-pole; 4,00 mm²; gray, green-yellow	<a href="http://www.wago.com/769-113/000-036">www.wago.com/769-113/000-036</a>
	<b>Item no.: 769-113/000-037</b> 1-conductor female plug; 4 mm²; 13-pole; 4,00 mm²; green-yellow, gray	<a href="http://www.wago.com/769-113/000-037">www.wago.com/769-113/000-037</a>
	<b>Item no.: 769-113/000-038</b> 1-conductor female plug; 4 mm²; 13-pole; 4,00 mm²; gray, blue, green-yellow	<a href="http://www.wago.com/769-113/000-038">www.wago.com/769-113/000-038</a>
	<b>Item no.: 769-113/000-039</b> 1-conductor female plug; 4 mm²; 13-pole; 4,00 mm²; green-yellow, blue, gray	<a href="http://www.wago.com/769-113/000-039">www.wago.com/769-113/000-039</a>
	<b>Item no.: 769-113/022-000</b> 1-conductor female plug; angled; 4 mm²; 13-pole; 4,00 mm²; gray	<a href="http://www.wago.com/769-113/022-000">www.wago.com/769-113/022-000</a>

Subject to changes. Please also observe the further product documentation!

	<b>Item no.: 769-114</b> 1-conductor female plug; 4 mm <sup>2</sup> ; 14-pole; 4,00 mm <sup>2</sup> ; gray	<a href="http://www.wago.com/769-114">www.wago.com/769-114</a>
	<b>Item no.: 769-114/000-006</b> 1-conductor female plug; 4 mm <sup>2</sup> ; 14-pole; 4,00 mm <sup>2</sup> ; blue	<a href="http://www.wago.com/769-114/000-006">www.wago.com/769-114/000-006</a>
	<b>Item no.: 769-114/000-036</b> 1-conductor female plug; 4 mm <sup>2</sup> ; 14-pole; 4,00 mm <sup>2</sup> ; gray, green-yellow	<a href="http://www.wago.com/769-114/000-036">www.wago.com/769-114/000-036</a>
	<b>Item no.: 769-114/000-037</b> 1-conductor female plug; 4 mm <sup>2</sup> ; 14-pole; 4,00 mm <sup>2</sup> ; green-yellow, gray	<a href="http://www.wago.com/769-114/000-037">www.wago.com/769-114/000-037</a>
	<b>Item no.: 769-114/000-038</b> 1-conductor female plug; 4 mm <sup>2</sup> ; 14-pole; 4,00 mm <sup>2</sup> ; gray, blue, green-yellow	<a href="http://www.wago.com/769-114/000-038">www.wago.com/769-114/000-038</a>
	<b>Item no.: 769-114/000-039</b> 1-conductor female plug; 4 mm <sup>2</sup> ; 14-pole; 4,00 mm <sup>2</sup> ; green-yellow, blue, gray	<a href="http://www.wago.com/769-114/000-039">www.wago.com/769-114/000-039</a>
	<b>Item no.: 769-114/022-000</b> 1-conductor female plug; angled; 4 mm <sup>2</sup> ; 14-pole; 4,00 mm <sup>2</sup> ; gray	<a href="http://www.wago.com/769-114/022-000">www.wago.com/769-114/022-000</a>
	<b>Item no.: 769-115</b> 1-conductor female plug; 4 mm <sup>2</sup> ; 15-pole; 4,00 mm <sup>2</sup> ; gray	<a href="http://www.wago.com/769-115">www.wago.com/769-115</a>
	<b>Item no.: 769-115/000-036</b> 1-conductor female plug; 4 mm <sup>2</sup> ; 15-pole; 4,00 mm <sup>2</sup> ; gray, green-yellow	<a href="http://www.wago.com/769-115/000-036">www.wago.com/769-115/000-036</a>
	<b>Item no.: 769-115/000-037</b> 1-conductor female plug; 4 mm <sup>2</sup> ; 15-pole; 4,00 mm <sup>2</sup> ; green-yellow, gray	<a href="http://www.wago.com/769-115/000-037">www.wago.com/769-115/000-037</a>
	<b>Item no.: 769-115/000-038</b> 1-conductor female plug; 4 mm <sup>2</sup> ; 15-pole; 4,00 mm <sup>2</sup> ; gray, blue, green-yellow	<a href="http://www.wago.com/769-115/000-038">www.wago.com/769-115/000-038</a>
	<b>Item no.: 769-115/000-039</b> 1-conductor female plug; 4 mm <sup>2</sup> ; 15-pole; 4,00 mm <sup>2</sup> ; green-yellow, blue, gray	<a href="http://www.wago.com/769-115/000-039">www.wago.com/769-115/000-039</a>
	<b>Item no.: 769-115/022-000</b> 1-conductor female plug; angled; 4 mm <sup>2</sup> ; 15-pole; 4,00 mm <sup>2</sup> ; gray	<a href="http://www.wago.com/769-115/022-000">www.wago.com/769-115/022-000</a>
<b>tools</b>		
	<b>Item no.: 210-720</b> Operating tool; Blade: 3.5 x 0.5 mm; with a partially insulated shaft	<a href="http://www.wago.com/210-720">www.wago.com/210-720</a>

Subject to changes. Please also observe the further product documentation!

### Test Accessories

**Item no.: 210-136**

Test plug; 2 mm Ø; with 500 mm cable; red

[www.wago.com/210-136](http://www.wago.com/210-136)
**Item no.: 210-137**

Test plug; 2.3 mm Ø; with 500 mm cable; yellow

[www.wago.com/210-137](http://www.wago.com/210-137)

### Protective Warning Marker

**Item no.: 280-415**

Protective warning marker; with high-voltage symbol, black; for 5 terminal blocks; yellow

[www.wago.com/280-415](http://www.wago.com/280-415)

### Marking accessories

**Item no.: 2009-145**

Mini-WSB Inline; for Smart Printer; 1700 pieces on roll; stretchable 5 - 5.2 mm; plain; snap-on type; white

[www.wago.com/2009-145](http://www.wago.com/2009-145)
**Item no.: 2009-145/000-002**

Mini-WSB Inline; for Smart Printer; 1700 pieces on roll; stretchable 5 - 5.2 mm; plain; snap-on type; white /000-002

[www.wago.com/2009-145](http://www.wago.com/2009-145)
**Item no.: 2009-145/000-005**

Mini-WSB Inline; for Smart Printer; 1700 pieces on roll; stretchable 5 - 5.2 mm; plain; snap-on type; red

[www.wago.com/2009-145](http://www.wago.com/2009-145)
**Item no.: 2009-145/000-006**

Mini-WSB Inline; for Smart Printer; 1700 pieces on roll; stretchable 5 - 5.2 mm; plain; snap-on type; blue

[www.wago.com/2009-145](http://www.wago.com/2009-145)
**Item no.: 2009-145/000-007**

Mini-WSB Inline; for Smart Printer; 1700 pieces on roll; stretchable 5 - 5.2 mm; plain; snap-on type; white /000-007

[www.wago.com/2009-145](http://www.wago.com/2009-145)
**Item no.: 2009-145/000-012**

Mini-WSB Inline; for Smart Printer; 1700 pieces on roll; stretchable 5 - 5.2 mm; plain; snap-on type; orange

[www.wago.com/2009-145](http://www.wago.com/2009-145)  
[/000-012](http://www.wago.com/2009-145/000-012)
**Item no.: 2009-145/000-023**

Mini-WSB Inline; for Smart Printer; 1700 pieces on roll; stretchable 5 - 5.2 mm; plain; snap-on type; green

[www.wago.com/2009-145](http://www.wago.com/2009-145)  
[/000-023](http://www.wago.com/2009-145/000-023)
**Item no.: 2009-145/000-024**

Mini-WSB Inline; for Smart Printer; 1700 pieces on roll; stretchable 5 - 5.2 mm; plain; snap-on type; violet

[www.wago.com/2009-145](http://www.wago.com/2009-145)  
[/000-024](http://www.wago.com/2009-145/000-024)
**Item no.: 248-501**

Miniature WSB Quick marking system; plain; Marker width 5 mm; 10 strips with 10 markers per card

[www.wago.com/248-501](http://www.wago.com/248-501)
**Item no.: 248-501/000-002**

Mini-WSB marking card; as card; not stretchable; plain; snap-on type; yellow

[www.wago.com/248-501](http://www.wago.com/248-501)  
[/000-002](http://www.wago.com/248-501/000-002)
**Item no.: 248-501/000-005**

Mini-WSB marking card; as card; not stretchable; plain; snap-on type; red

[www.wago.com/248-501](http://www.wago.com/248-501)  
[/000-005](http://www.wago.com/248-501/000-005)

Subject to changes. Please also observe the further product documentation!

WAGO Kontakttechnik GmbH &amp; Co. KG

Hansastr. 27

32423 Minden

Phone: +49571 887-0 | Fax: +49571 887-169

Email: [info.de@wago.com](mailto:info.de@wago.com) | Web: [www.wago.com](http://www.wago.com)

Do you have any questions about our products?

We are always happy to take your call at +49 (571) 887-44222.



**Item no.: 248-501/000-006**  
Mini-WSB marking card; as card; not stretchable; plain; snap-on type; blue

[www.wago.com/248-501/000-006](http://www.wago.com/248-501/000-006)

**Item no.: 248-501/000-007**  
Mini-WSB marking card; as card; not stretchable; plain; snap-on type; gray

[www.wago.com/248-501/000-007](http://www.wago.com/248-501/000-007)

**Item no.: 248-501/000-012**  
Mini-WSB marking card; as card; not stretchable; plain; snap-on type; orange

[www.wago.com/248-501/000-012](http://www.wago.com/248-501/000-012)



**Item no.: 248-501/000-017**  
Mini-WSB marking card; as card; not stretchable; plain; snap-on type; light green

[www.wago.com/248-501/000-017](http://www.wago.com/248-501/000-017)



**Item no.: 248-501/000-023**  
Mini-WSB marking card; as card; not stretchable; plain; snap-on type; green

[www.wago.com/248-501/000-023](http://www.wago.com/248-501/000-023)

**Item no.: 248-501/000-024**  
Mini-WSB marking card; as card; not stretchable; plain; snap-on type; violet

[www.wago.com/248-501/000-024](http://www.wago.com/248-501/000-024)

#### ferrule



**Item no.: 216-101**  
Ferrule; Sleeve for 0.5 mm<sup>2</sup> / AWG 22; uninsulated; electro-tin plated

[www.wago.com/216-101](http://www.wago.com/216-101)

**Item no.: 216-102**  
Ferrule; Sleeve for 0.75 mm<sup>2</sup> / AWG 20; uninsulated; electro-tin plated

[www.wago.com/216-102](http://www.wago.com/216-102)



**Item no.: 216-103**  
Ferrule; Sleeve for 1 mm<sup>2</sup> / AWG 18; uninsulated; electro-tin plated

[www.wago.com/216-103](http://www.wago.com/216-103)

**Item no.: 216-104**  
Ferrule; Sleeve for 1.5 mm<sup>2</sup> / AWG 16; uninsulated; electro-tin plated

[www.wago.com/216-104](http://www.wago.com/216-104)

**Item no.: 216-201**  
Ferrule; Sleeve for 0.5 mm<sup>2</sup> / 20 AWG; insulated; electro-tin plated; white

[www.wago.com/216-201](http://www.wago.com/216-201)



**Item no.: 216-202**  
Ferrule; Sleeve for 0.75 mm<sup>2</sup> / 18 AWG; insulated; electro-tin plated; gray

[www.wago.com/216-202](http://www.wago.com/216-202)

**Item no.: 216-203**  
Ferrule; Sleeve for 1 mm<sup>2</sup> / AWG 18; insulated; electro-tin plated; red

[www.wago.com/216-203](http://www.wago.com/216-203)

**Item no.: 216-204**  
Ferrule; Sleeve for 1.5 mm<sup>2</sup> / AWG 16; insulated; electro-tin plated; black

[www.wago.com/216-204](http://www.wago.com/216-204)



**Item no.: 216-206**  
Ferrule; Sleeve for 2.5 mm<sup>2</sup> / AWG 14; insulated; electro-tin plated; blue

[www.wago.com/216-206](http://www.wago.com/216-206)

**Item no.: 216-301**

Subject to changes. Please also observe the further product documentation!



Ferrule; Sleeve for 0.25 mm<sup>2</sup> / AWG 24; insulated; electro-tin plated; yellow

[www.wago.com/216-301](http://www.wago.com/216-301)

Item no.: 216-302

Ferrule; Sleeve for 0.34 mm<sup>2</sup> / 22 AWG; insulated; electro-tin plated; green

[www.wago.com/216-302](http://www.wago.com/216-302)

#### End plate



Item no.: 769-307

End and intermediate plate; 1.1 mm thick; gray

[www.wago.com/769-307](http://www.wago.com/769-307)



Item no.: 769-308

End and intermediate plate; 1.1 mm thick; orange

[www.wago.com/769-308](http://www.wago.com/769-308)

## Downloads

### Documentation

#### Additional Information

Technical explanations

Apr 3, 2019

pdf  
2.1 MB

[Download](#)

## CAD/CAE-Data

### CAD data

2D/3D Models 769-232

[URL](#)

[Download](#)

### CAE data

EPLAN Data Portal 769-232

[URL](#)

[Download](#)

WSCAD Universe 769-232

[URL](#)

[Download](#)

## Installation Notes

### Assembly

Subject to changes. Please also observe the further product documentation!

WAGO Kontakttechnik GmbH & Co. KG

Hansastr. 27

32423 Minden

Phone: +49571 887-0 | Fax: +49571 887-169

Email: [info.de@wago.com](mailto:info.de@wago.com) | Web: [www.wago.com](http://www.wago.com)

Do you have any questions about our products?

We are always happy to take your call at +49 (571) 887-44222.

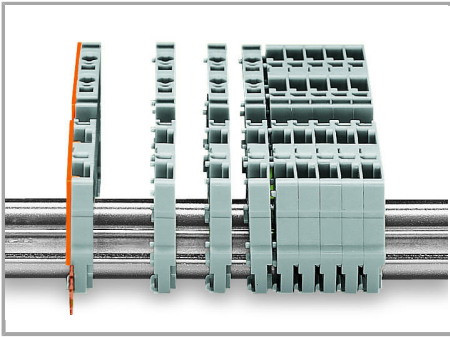

Snap individual carrier terminal blocks onto the carrier rail and slide together.

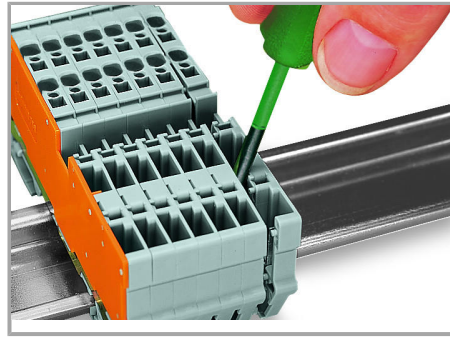

Open the assembly by laterally sliding a block via operating tool and remove terminal block via release lever.

#### Inserting a conductor

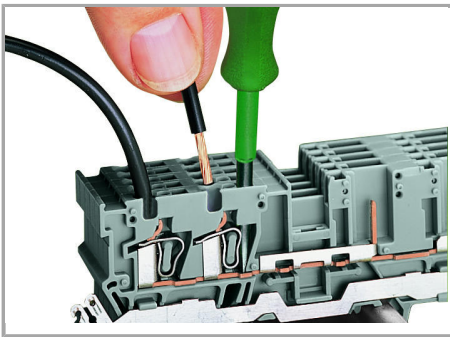

#### CAGE CLAMP® connection

Carrier terminal block: Insert/remove conductor via operating tool (3.5 x 0.5 mm blade).

#### Jumpered

Subject to changes. Please also observe the further product documentation!

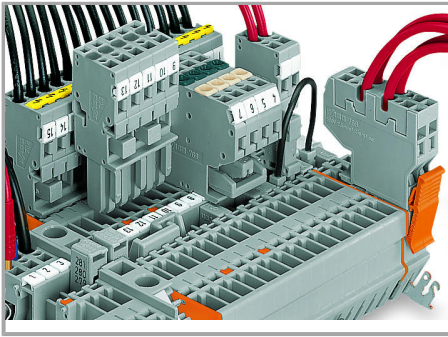

Commoning with adjacent or staggered jumpers –

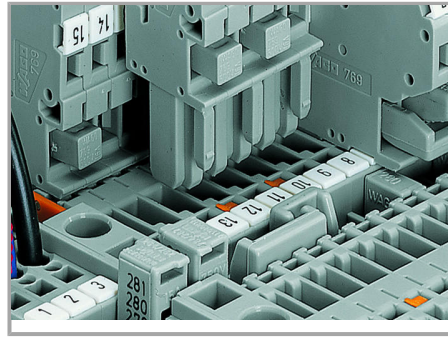

Commoning carrier terminal blocks via staggered jumpers.

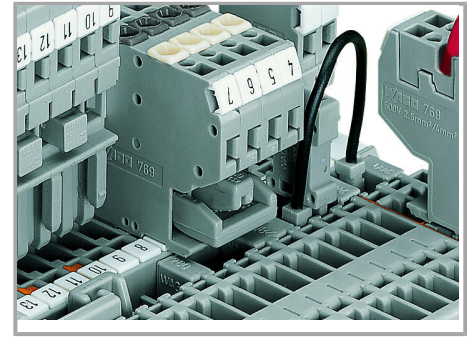

Commoning a 2-conductor female plug via staggered jumper and carrier terminal blocks via adjacent jumpers.

push jumpers down until fully inserted.

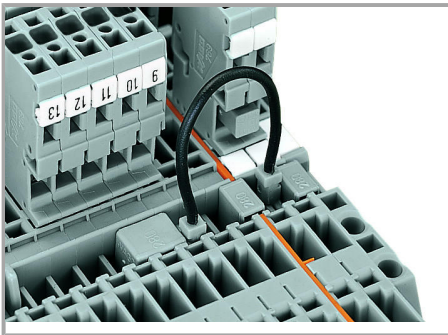

Commoning carrier terminal blocks via push-in type wire jumpers or adjacent jumpers – even over an intermediate plate.

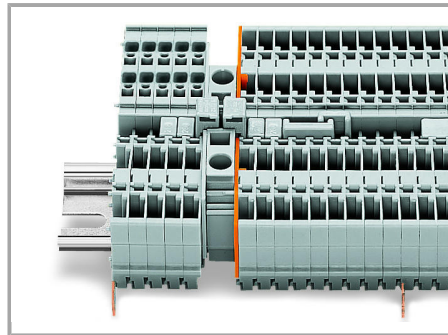

Commoning “supply terminal blocks” (up to 10 mm<sup>2</sup>/8 AWG) with carrier terminal blocks via step-down jumpers.

### Testing

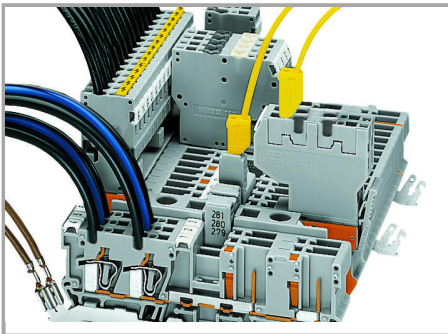

Testing via 2 or 2.3 mm Ø test plugs.

Subject to changes. Please also observe the further product documentation!

### Coding

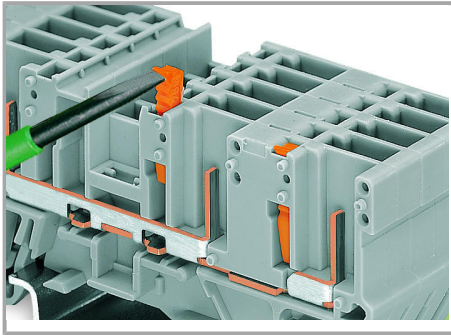

Snap coding pin in proper direction on carrier terminal block.

Shown: Coding pin removal from carrier terminal block.

### Locking

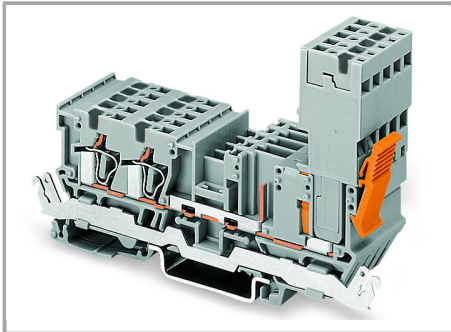

Female plug secured with locking lever on the terminal block side.

Subject to changes. Please also observe the further product documentation!

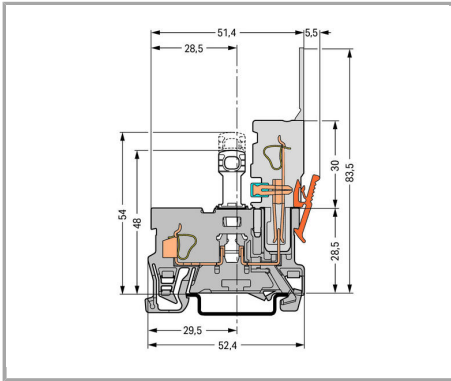

Disconnect carrier terminal block

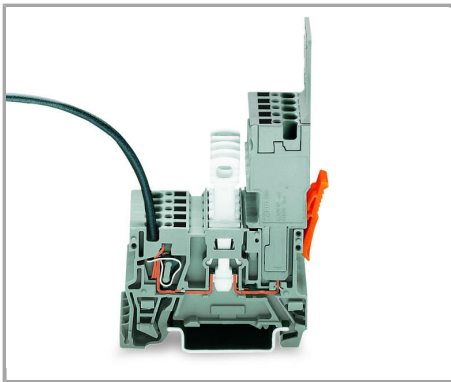

1-conductor female plug

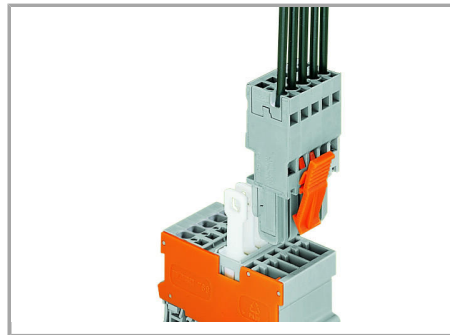

1-conductor/1-pin disconnect carrier terminal block

Disconnect carrier terminal blocks cannot be commoned.

1-connector female plug, straight\*

\*1-conductor angled female plug is also possible!

### Safety

Subject to changes. Please also observe the further product documentation!

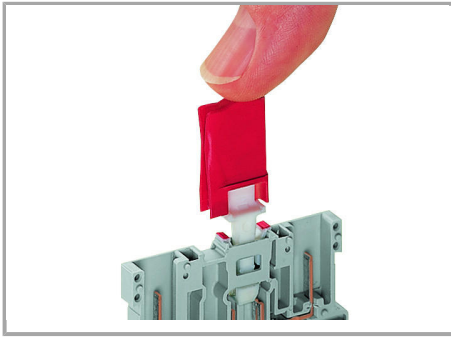

Installing a disconnect lock on the terminal block's disconnect tab.

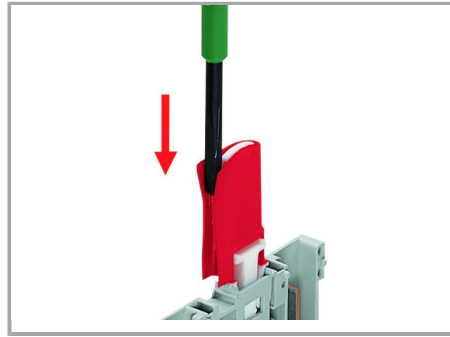

Unlocking a disconnect lock.

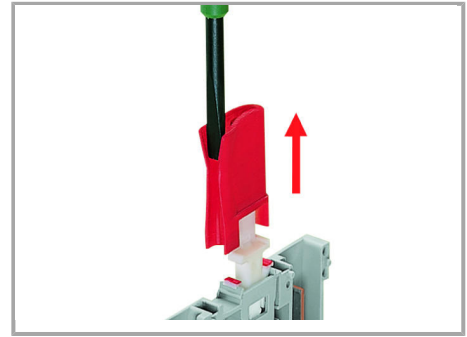

Removing a disconnect lock.

## Product family

### X-COM

[Learn more about the product family.](#)

[Show all products from the family](#)

Subject to changes. Please also observe the further product documentation!