

## Data sheet | Item number: 769-218/281-410

1-conductor/1-pin component carrier terminal block; with 2 jumper positions; with diode 1N4007; anode, left side; for DIN-rail 35 x 15 and 35 x 7.5; 4 mm<sup>2</sup>; CAGE CLAMP®; 4,00 mm<sup>2</sup>; gray

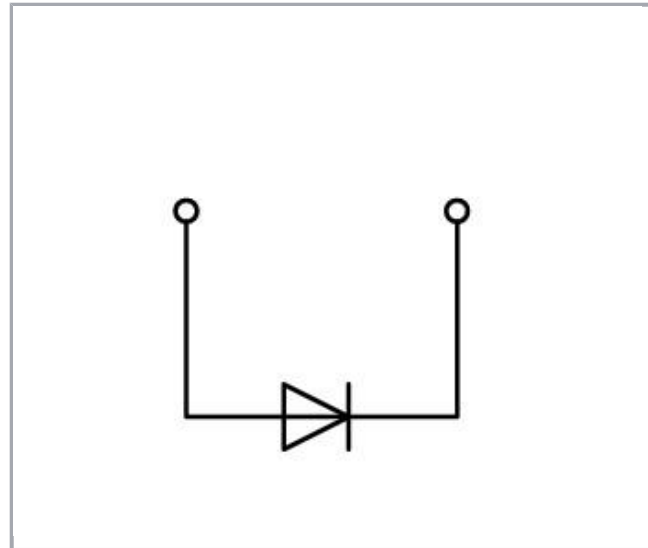

[www.wago.com/769-218/281-410](http://www.wago.com/769-218/281-410)

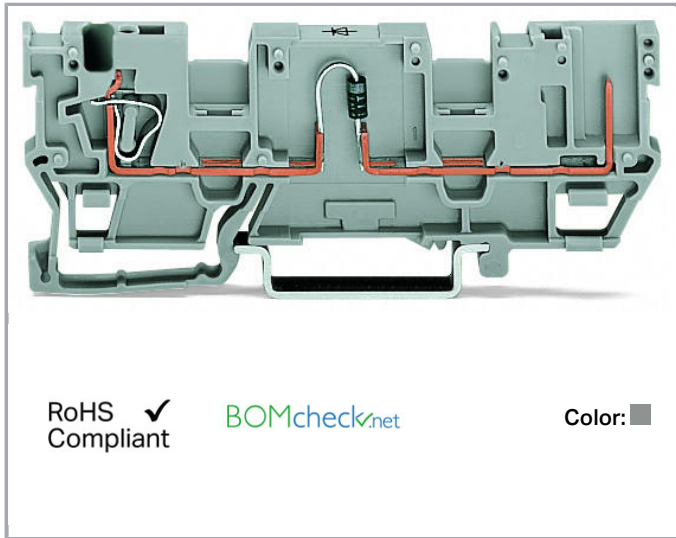

### Data

#### Electrical data

Nominal voltage	250 V
Reverse voltage	1,000 V

#### Ratings per IEC/EN 60664-1

Rated current	0.5 A
---------------	-------

#### Connection data

Connection technology	CAGE CLAMP®
Actuation type	Open Tool Slot
Connectable conductor materials	Copper
Nominal cross section	4 mm <sup>2</sup>
Solid conductor	0,08 ... 4 mm <sup>2</sup> / 28 ... 12 AWG
Fine-stranded conductor	0,08 ... 4 mm <sup>2</sup> / 28 ... 12 AWG
Strip length	8 ... 9 mm / 0.31 ... 0.35 inch
Total number of connection points	1
Total number of potentials	1

Subject to changes. Please also observe the further product documentation!

WAGO Kontakttechnik GmbH & Co. KG  
Hansastr. 27  
32423 Minden  
Phone: +49571 887-0 | Fax: +49571 887-169  
Email: [info.de@wago.com](mailto:info.de@wago.com) | Web: [www.wago.com](http://www.wago.com)

Do you have any questions about our products?  
We are always happy to take your call at +49 (571) 887-44222.

Number of levels	1
Type of wiring	Front-entry wiring

### Geometrical Data

Width	5 mm / 0.197 inch
Height from upper-edge of DIN-35 rail	28,5 mm / 1.122 inch
Depth	87,5 mm / 3.445 inch

### Mechanical data

Design	horizontal
Type of mounting	DIN-35 rail
Marking level	Center marking

### Material Data



Color	gray
Insulating material	Polyamide 66 (PA 66)
Fire load	0.173 MJ
Weight	8.1 g

### Commercial data

Product Group	18 (X-COM-System)
Packaging type	BOX
Country of origin	DE
GTIN	4045454198381
Customs Tariff No.	85369010000

### Approvals / Certificates

#### Country specific Approvals

Logo	Approval	Additional Approval Text	Certificate name
	CCA DEKRA Certification B.V.	EN 60947	NTR NL- 7626
	CSA DEKRA Certification B.V.	C22.2 No. 158	1101144

Subject to changes. Please also observe the further product documentation!





KEMA/KEUR  
DEKRA Certification B.V.

EN 60947

2190419.01



### Ship Approvals

Logo	Approval	Additional Approval Text	Certificate name
	<b>ABS</b> American Bureau of Shipping	EN 60947	20- HG1941090- PDA
	<b>DNV GL</b> Det Norske Veritas, Germanischer Lloyd	-	TAE00001V2

### Counterpart

### Compatible products

#### End plate

	<b>Item no.: 769-311</b> End and intermediate plate; 1.1 mm thick; gray	<a href="http://www.wago.com/769-311">www.wago.com/769-311</a>
	<b>Item no.: 769-312</b> End and intermediate plate; 1.1 mm thick; orange	<a href="http://www.wago.com/769-312">www.wago.com/769-312</a>
	<b>Item no.: 769-314</b> Separator plate; 1.1 mm thick; oversized; orange	<a href="http://www.wago.com/769-314">www.wago.com/769-314</a>

#### tools

Subject to changes. Please also observe the further product documentation!

WAGO Kontakttechnik GmbH & Co. KG  
Hansastr. 27  
32423 Minden  
Phone: +49571 887-0 | Fax: +49571 887-169  
Email: [info.de@wago.com](mailto:info.de@wago.com) | Web: [www.wago.com](http://www.wago.com)

Do you have any questions about our products?  
We are always happy to take your call at +49 (571) 887-44222.



**Item no.: 210-720**  
Operating tool; Blade: 3.5 x 0.5 mm; with a partially insulated shaft

[www.wago.com/210-720](http://www.wago.com/210-720)

**Coding**



**Item no.: 769-435**  
Coding pin; for coding of female plugs; for carrier terminal blocks / male connectors; orange

[www.wago.com/769-435](http://www.wago.com/769-435)

**Female plug**



**Item no.: 769-101**  
1-conductor female plug; 4 mm<sup>2</sup>; 1-pole; 4,00 mm<sup>2</sup>; gray

[www.wago.com/769-101](http://www.wago.com/769-101)



**Item no.: 769-101/000-006**  
1-conductor female plug; 4 mm<sup>2</sup>; 1-pole; 4,00 mm<sup>2</sup>; blue

[www.wago.com/769-101/000-006](http://www.wago.com/769-101/000-006)

**Item no.: 769-101/000-016**  
1-conductor female plug; 4 mm<sup>2</sup>; 1-pole; 4,00 mm<sup>2</sup>; green-yellow

[www.wago.com/769-101/000-016](http://www.wago.com/769-101/000-016)



**Item no.: 769-101/022-000**  
1-conductor female plug; angled; 4 mm<sup>2</sup>; 1-pole; 4,00 mm<sup>2</sup>; gray

[www.wago.com/769-101/022-000](http://www.wago.com/769-101/022-000)



**Item no.: 769-101/022-016**  
1-conductor female plug; angled; 4 mm<sup>2</sup>; 1-pole; 4,00 mm<sup>2</sup>; green-yellow

[www.wago.com/769-101/022-016](http://www.wago.com/769-101/022-016)



**Item no.: 769-102**  
1-conductor female plug; 4 mm<sup>2</sup>; 2-pole; 4,00 mm<sup>2</sup>; gray

[www.wago.com/769-102](http://www.wago.com/769-102)



**Item no.: 769-102/000-006**  
1-conductor female plug; 4 mm<sup>2</sup>; 2-pole; 4,00 mm<sup>2</sup>; blue

[www.wago.com/769-102/000-006](http://www.wago.com/769-102/000-006)

**Item no.: 769-102/000-036**  
1-conductor female plug; 4 mm<sup>2</sup>; 2-pole; 4,00 mm<sup>2</sup>; gray, green-yellow

[www.wago.com/769-102/000-036](http://www.wago.com/769-102/000-036)



**Item no.: 769-102/000-037**  
1-conductor female plug; 4 mm<sup>2</sup>; 2-pole; 4,00 mm<sup>2</sup>; green-yellow, gray

[www.wago.com/769-102/000-037](http://www.wago.com/769-102/000-037)



**Item no.: 769-102/022-000**  
1-conductor female plug; angled; 4 mm<sup>2</sup>; 2-pole; 4,00 mm<sup>2</sup>; gray

[www.wago.com/769-102/022-000](http://www.wago.com/769-102/022-000)



**Item no.: 769-103**  
1-conductor female plug; 4 mm<sup>2</sup>; 3-pole; 4,00 mm<sup>2</sup>; gray

[www.wago.com/769-103](http://www.wago.com/769-103)



**Item no.: 769-103/000-006**  
1-conductor female plug; 4 mm<sup>2</sup>; 3-pole; 4,00 mm<sup>2</sup>; blue

[www.wago.com/769-103/000-006](http://www.wago.com/769-103/000-006)

Subject to changes. Please also observe the further product documentation!



**Item no.: 769-103/000-036**  
1-conductor female plug; 4 mm<sup>2</sup>; 3-pole; 4,00 mm<sup>2</sup>; gray, green-yellow

[www.wago.com/769-103/000-036](http://www.wago.com/769-103/000-036)



**Item no.: 769-103/000-037**  
1-conductor female plug; 4 mm<sup>2</sup>; 3-pole; 4,00 mm<sup>2</sup>; green-yellow, gray

[www.wago.com/769-103/000-037](http://www.wago.com/769-103/000-037)

**Item no.: 769-103/000-038**  
1-conductor female plug; 4 mm<sup>2</sup>; 3-pole; 4,00 mm<sup>2</sup>; gray, blue, green-yellow

[www.wago.com/769-103/000-038](http://www.wago.com/769-103/000-038)



**Item no.: 769-103/000-039**  
1-conductor female plug; 4 mm<sup>2</sup>; 3-pole; 4,00 mm<sup>2</sup>; green-yellow, blue, gray

[www.wago.com/769-103/000-039](http://www.wago.com/769-103/000-039)

**Item no.: 769-103/022-000**  
1-conductor female plug; angled; 4 mm<sup>2</sup>; 3-pole; 4,00 mm<sup>2</sup>; gray

[www.wago.com/769-103/022-000](http://www.wago.com/769-103/022-000)



**Item no.: 769-104**  
1-conductor female plug; 4 mm<sup>2</sup>; 4-pole; 4,00 mm<sup>2</sup>; gray

[www.wago.com/769-104](http://www.wago.com/769-104)

**Item no.: 769-104/000-006**  
1-conductor female plug; 4 mm<sup>2</sup>; 4-pole; 4,00 mm<sup>2</sup>; blue

[www.wago.com/769-104/000-006](http://www.wago.com/769-104/000-006)



**Item no.: 769-104/000-036**  
1-conductor female plug; 4 mm<sup>2</sup>; 4-pole; 4,00 mm<sup>2</sup>; gray, green-yellow

[www.wago.com/769-104/000-036](http://www.wago.com/769-104/000-036)



**Item no.: 769-104/000-037**  
1-conductor female plug; 4 mm<sup>2</sup>; 4-pole; 4,00 mm<sup>2</sup>; green-yellow, gray

[www.wago.com/769-104/000-037](http://www.wago.com/769-104/000-037)

**Item no.: 769-104/000-038**  
1-conductor female plug; 4 mm<sup>2</sup>; 4-pole; 4,00 mm<sup>2</sup>; gray, blue, green-yellow

[www.wago.com/769-104/000-038](http://www.wago.com/769-104/000-038)

**Item no.: 769-104/000-039**  
1-conductor female plug; 4 mm<sup>2</sup>; 4-pole; 4,00 mm<sup>2</sup>; green-yellow, blue, gray

[www.wago.com/769-104/000-039](http://www.wago.com/769-104/000-039)

**Item no.: 769-104/022-000**  
1-conductor female plug; angled; 4 mm<sup>2</sup>; 4-pole; 4,00 mm<sup>2</sup>; gray

[www.wago.com/769-104/022-000](http://www.wago.com/769-104/022-000)



**Item no.: 769-105**  
1-conductor female plug; 4 mm<sup>2</sup>; 5-pole; 4,00 mm<sup>2</sup>; gray

[www.wago.com/769-105](http://www.wago.com/769-105)



**Item no.: 769-105/000-006**  
1-conductor female plug; 4 mm<sup>2</sup>; 5-pole; 4,00 mm<sup>2</sup>; blue

[www.wago.com/769-105/000-006](http://www.wago.com/769-105/000-006)

Subject to changes. Please also observe the further product documentation!

WAGO Kontakttechnik GmbH & Co. KG

Hansastr. 27

32423 Minden

Phone: +49571 887-0 | Fax: +49571 887-169

Email: [info.de@wago.com](mailto:info.de@wago.com) | Web: [www.wago.com](http://www.wago.com)

Do you have any questions about our products?

We are always happy to take your call at +49 (571) 887-44222.



**Item no.: 769-105/000-036**  
1-conductor female plug; 4 mm<sup>2</sup>; 5-pole; 4,00 mm<sup>2</sup>; gray, green-yellow

[www.wago.com/769-105/000-036](http://www.wago.com/769-105/000-036)

**Item no.: 769-105/000-037**  
1-conductor female plug; 4 mm<sup>2</sup>; 5-pole; 4,00 mm<sup>2</sup>; green-yellow, gray

[www.wago.com/769-105/000-037](http://www.wago.com/769-105/000-037)



**Item no.: 769-105/000-038**  
1-conductor female plug; 4 mm<sup>2</sup>; 5-pole; 4,00 mm<sup>2</sup>; gray, blue, green-yellow

[www.wago.com/769-105/000-038](http://www.wago.com/769-105/000-038)



**Item no.: 769-105/000-039**  
1-conductor female plug; 4 mm<sup>2</sup>; 5-pole; 4,00 mm<sup>2</sup>; green-yellow, blue, gray

[www.wago.com/769-105/000-039](http://www.wago.com/769-105/000-039)



**Item no.: 769-105/022-000**  
1-conductor female plug; angled; 4 mm<sup>2</sup>; 5-pole; 4,00 mm<sup>2</sup>; gray

[www.wago.com/769-105/022-000](http://www.wago.com/769-105/022-000)

**Item no.: 769-106**  
1-conductor female plug; 4 mm<sup>2</sup>; 6-pole; 4,00 mm<sup>2</sup>; gray

[www.wago.com/769-106](http://www.wago.com/769-106)



**Item no.: 769-106/000-006**  
1-conductor female plug; 4 mm<sup>2</sup>; 6-pole; 4,00 mm<sup>2</sup>; blue

[www.wago.com/769-106/000-006](http://www.wago.com/769-106/000-006)



**Item no.: 769-106/000-036**  
1-conductor female plug; 4 mm<sup>2</sup>; 6-pole; 4,00 mm<sup>2</sup>; gray, green-yellow

[www.wago.com/769-106/000-036](http://www.wago.com/769-106/000-036)

**Item no.: 769-106/000-037**  
1-conductor female plug; 4 mm<sup>2</sup>; 6-pole; 4,00 mm<sup>2</sup>; green-yellow, gray

[www.wago.com/769-106/000-037](http://www.wago.com/769-106/000-037)

**Item no.: 769-106/000-038**  
1-conductor female plug; 4 mm<sup>2</sup>; 6-pole; 4,00 mm<sup>2</sup>; gray, blue, green-yellow

[www.wago.com/769-106/000-038](http://www.wago.com/769-106/000-038)

**Item no.: 769-106/000-039**  
1-conductor female plug; 4 mm<sup>2</sup>; 6-pole; 4,00 mm<sup>2</sup>; green-yellow, blue, gray

[www.wago.com/769-106/000-039](http://www.wago.com/769-106/000-039)



**Item no.: 769-106/022-000**  
1-conductor female plug; angled; 4 mm<sup>2</sup>; 6-pole; 4,00 mm<sup>2</sup>; gray

[www.wago.com/769-106/022-000](http://www.wago.com/769-106/022-000)



**Item no.: 769-107**  
1-conductor female plug; 4 mm<sup>2</sup>; 7-pole; 4,00 mm<sup>2</sup>; gray

[www.wago.com/769-107](http://www.wago.com/769-107)

**Item no.: 769-107/000-006**  
1-conductor female plug; 4 mm<sup>2</sup>; 7-pole; 4,00 mm<sup>2</sup>; blue

[www.wago.com/769-107/000-006](http://www.wago.com/769-107/000-006)

Subject to changes. Please also observe the further product documentation!



**Item no.: 769-107/000-036**  
1-conductor female plug; 4 mm<sup>2</sup>; 7-pole; 4,00 mm<sup>2</sup>; gray, green-yellow

[www.wago.com/769-107/000-036](http://www.wago.com/769-107/000-036)



**Item no.: 769-107/000-037**  
1-conductor female plug; 4 mm<sup>2</sup>; 7-pole; 4,00 mm<sup>2</sup>; green-yellow, gray

[www.wago.com/769-107/000-037](http://www.wago.com/769-107/000-037)

**Item no.: 769-107/000-038**  
1-conductor female plug; 4 mm<sup>2</sup>; 7-pole; 4,00 mm<sup>2</sup>; gray, blue, green-yellow

[www.wago.com/769-107/000-038](http://www.wago.com/769-107/000-038)

**Item no.: 769-107/000-039**  
1-conductor female plug; 4 mm<sup>2</sup>; 7-pole; 4,00 mm<sup>2</sup>; green-yellow, blue, gray

[www.wago.com/769-107/000-039](http://www.wago.com/769-107/000-039)

**Item no.: 769-107/022-000**  
1-conductor female plug; angled; 4 mm<sup>2</sup>; 7-pole; 4,00 mm<sup>2</sup>; gray

[www.wago.com/769-107/022-000](http://www.wago.com/769-107/022-000)



**Item no.: 769-108**  
1-conductor female plug; 4 mm<sup>2</sup>; 8-pole; 4,00 mm<sup>2</sup>; gray

[www.wago.com/769-108](http://www.wago.com/769-108)



**Item no.: 769-108/000-006**  
1-conductor female plug; 4 mm<sup>2</sup>; 8-pole; 4,00 mm<sup>2</sup>; blue

[www.wago.com/769-108/000-006](http://www.wago.com/769-108/000-006)



**Item no.: 769-108/000-036**  
1-conductor female plug; 4 mm<sup>2</sup>; 8-pole; 4,00 mm<sup>2</sup>; gray, green-yellow

[www.wago.com/769-108/000-036](http://www.wago.com/769-108/000-036)



**Item no.: 769-108/000-037**  
1-conductor female plug; 4 mm<sup>2</sup>; 8-pole; 4,00 mm<sup>2</sup>; green-yellow, gray

[www.wago.com/769-108/000-037](http://www.wago.com/769-108/000-037)



**Item no.: 769-108/000-038**  
1-conductor female plug; 4 mm<sup>2</sup>; 8-pole; 4,00 mm<sup>2</sup>; gray, blue, green-yellow

[www.wago.com/769-108/000-038](http://www.wago.com/769-108/000-038)



**Item no.: 769-108/000-039**  
1-conductor female plug; 4 mm<sup>2</sup>; 8-pole; 4,00 mm<sup>2</sup>; green-yellow, blue, gray

[www.wago.com/769-108/000-039](http://www.wago.com/769-108/000-039)



**Item no.: 769-108/022-000**  
1-conductor female plug; angled; 4 mm<sup>2</sup>; 8-pole; 4,00 mm<sup>2</sup>; gray

[www.wago.com/769-108/022-000](http://www.wago.com/769-108/022-000)



**Item no.: 769-109**  
1-conductor female plug; 4 mm<sup>2</sup>; 9-pole; 4,00 mm<sup>2</sup>; gray















[www.wago.com/769-109](http://www.wago.com/769-109)



**Item no.: 769-109/000-006**  
1-conductor female plug; 4 mm<sup>2</sup>; 9-pole; 4,00 mm<sup>2</sup>; blue















[www.wago.com/769-109/000-006](http://www.wago.com/769-109/000-006)

Subject to changes. Please also observe the further product documentation!

	<b>Item no.: 769-109/000-036</b> 1-conductor female plug; 4 mm <sup>2</sup> ; 9-pole; 4,00 mm <sup>2</sup> ; gray, green-yellow	<a href="http://www.wago.com/769-109/000-036">www.wago.com/769-109/000-036</a>
	<b>Item no.: 769-109/000-037</b> 1-conductor female plug; 4 mm <sup>2</sup> ; 9-pole; 4,00 mm <sup>2</sup> ; green-yellow, gray	<a href="http://www.wago.com/769-109/000-037">www.wago.com/769-109/000-037</a>
	<b>Item no.: 769-109/000-038</b> 1-conductor female plug; 4 mm <sup>2</sup> ; 9-pole; 4,00 mm <sup>2</sup> ; gray, blue, green-yellow	<a href="http://www.wago.com/769-109/000-038">www.wago.com/769-109/000-038</a>
	<b>Item no.: 769-109/000-039</b> 1-conductor female plug; 4 mm <sup>2</sup> ; 9-pole; 4,00 mm <sup>2</sup> ; green-yellow, blue, gray	<a href="http://www.wago.com/769-109/000-039">www.wago.com/769-109/000-039</a>
	<b>Item no.: 769-109/022-000</b> 1-conductor female plug; angled; 4 mm <sup>2</sup> ; 9-pole; 4,00 mm <sup>2</sup> ; gray	<a href="http://www.wago.com/769-109/022-000">www.wago.com/769-109/022-000</a>
	<b>Item no.: 769-110</b> 1-conductor female plug; 4 mm <sup>2</sup> ; 10-pole; 4,00 mm <sup>2</sup> ; gray	<a href="http://www.wago.com/769-110">www.wago.com/769-110</a>
	<b>Item no.: 769-110/000-006</b> 1-conductor female plug; 4 mm <sup>2</sup> ; 10-pole; 4,00 mm <sup>2</sup> ; blue	<a href="http://www.wago.com/769-110/000-006">www.wago.com/769-110/000-006</a>
	<b>Item no.: 769-110/000-036</b> 1-conductor female plug; 4 mm <sup>2</sup> ; 10-pole; 4,00 mm <sup>2</sup> ; gray, green-yellow	<a href="http://www.wago.com/769-110/000-036">www.wago.com/769-110/000-036</a>
	<b>Item no.: 769-110/000-037</b> 1-conductor female plug; 4 mm <sup>2</sup> ; 10-pole; 4,00 mm <sup>2</sup> ; green-yellow, gray	<a href="http://www.wago.com/769-110/000-037">www.wago.com/769-110/000-037</a>
	<b>Item no.: 769-110/000-038</b> 1-conductor female plug; 4 mm <sup>2</sup> ; 10-pole; 4,00 mm <sup>2</sup> ; gray, blue, green-yellow	<a href="http://www.wago.com/769-110/000-038">www.wago.com/769-110/000-038</a>
	<b>Item no.: 769-110/000-039</b> 1-conductor female plug; 4 mm <sup>2</sup> ; 10-pole; 4,00 mm <sup>2</sup> ; green-yellow, blue, gray	<a href="http://www.wago.com/769-110/000-039">www.wago.com/769-110/000-039</a>
	<b>Item no.: 769-110/022-000</b> 1-conductor female plug; angled; 4 mm <sup>2</sup> ; 10-pole; 4,00 mm <sup>2</sup> ; gray	<a href="http://www.wago.com/769-110/022-000">www.wago.com/769-110/022-000</a>
	<b>Item no.: 769-111</b> 1-conductor female plug; 4 mm <sup>2</sup> ; 11-pole; 4,00 mm <sup>2</sup> ; gray	<a href="http://www.wago.com/769-111">www.wago.com/769-111</a>
	<b>Item no.: 769-111/000-006</b> 1-conductor female plug; 4 mm <sup>2</sup> ; 11-pole; 4,00 mm <sup>2</sup> ; blue	<a href="http://www.wago.com/769-111/000-006">www.wago.com/769-111/000-006</a>

Subject to changes. Please also observe the further product documentation!



	<b>Item no.: 769-111/000-036</b> 1-conductor female plug; 4 mm²; 11-pole; 4,00 mm²; gray, green-yellow	<a href="http://www.wago.com/769-111/000-036">www.wago.com/769-111/000-036</a>
	<b>Item no.: 769-111/000-037</b> 1-conductor female plug; 4 mm²; 11-pole; 4,00 mm²; green-yellow, gray	<a href="http://www.wago.com/769-111/000-037">www.wago.com/769-111/000-037</a>
	<b>Item no.: 769-111/000-038</b> 1-conductor female plug; 4 mm²; 11-pole; 4,00 mm²; gray, blue, green-yellow	<a href="http://www.wago.com/769-111/000-038">www.wago.com/769-111/000-038</a>
	<b>Item no.: 769-111/000-039</b> 1-conductor female plug; 4 mm²; 11-pole; 4,00 mm²; green-yellow, blue, gray	<a href="http://www.wago.com/769-111/000-039">www.wago.com/769-111/000-039</a>
	<b>Item no.: 769-111/022-000</b> 1-conductor female plug; angled; 4 mm²; 11-pole; 4,00 mm²; gray	<a href="http://www.wago.com/769-111/022-000">www.wago.com/769-111/022-000</a>
	<b>Item no.: 769-112</b> 1-conductor female plug; 4 mm²; 12-pole; 4,00 mm²; gray	<a href="http://www.wago.com/769-112">www.wago.com/769-112</a>
	<b>Item no.: 769-112/000-006</b> 1-conductor female plug; 4 mm²; 12-pole; 4,00 mm²; blue	<a href="http://www.wago.com/769-112/000-006">www.wago.com/769-112/000-006</a>
	<b>Item no.: 769-112/000-036</b> 1-conductor female plug; 4 mm²; 12-pole; 4,00 mm²; gray, green-yellow	<a href="http://www.wago.com/769-112/000-036">www.wago.com/769-112/000-036</a>
	<b>Item no.: 769-112/000-037</b> 1-conductor female plug; 4 mm²; 12-pole; 4,00 mm²; green-yellow, gray	<a href="http://www.wago.com/769-112/000-037">www.wago.com/769-112/000-037</a>
	<b>Item no.: 769-112/000-038</b> 1-conductor female plug; 4 mm²; 12-pole; 4,00 mm²; gray, blue, green-yellow	<a href="http://www.wago.com/769-112/000-038">www.wago.com/769-112/000-038</a>
	<b>Item no.: 769-112/000-039</b> 1-conductor female plug; 4 mm²; 12-pole; 4,00 mm²; green-yellow, blue, gray	<a href="http://www.wago.com/769-112/000-039">www.wago.com/769-112/000-039</a>
	<b>Item no.: 769-112/022-000</b> 1-conductor female plug; angled; 4 mm²; 12-pole; 4,00 mm²; gray	<a href="http://www.wago.com/769-112/022-000">www.wago.com/769-112/022-000</a>
	<b>Item no.: 769-113</b> 1-conductor female plug; 4 mm²; 13-pole; 4,00 mm²; gray	<a href="http://www.wago.com/769-113">www.wago.com/769-113</a>
	<b>Item no.: 769-113/000-036</b> 1-conductor female plug; 4 mm²; 13-pole; 4,00 mm²; gray, green-yellow	<a href="http://www.wago.com/769-113/000-036">www.wago.com/769-113/000-036</a>

Subject to changes. Please also observe the further product documentation!



**Item no.: 769-113/000-037**

1-conductor female plug; 4 mm<sup>2</sup>; 13-pole; 4,00 mm<sup>2</sup>; green-yellow, gray

[www.wago.com/769-113/000-037](http://www.wago.com/769-113/000-037)



**Item no.: 769-113/000-038**

1-conductor female plug; 4 mm<sup>2</sup>; 13-pole; 4,00 mm<sup>2</sup>; gray, blue, green-yellow

[www.wago.com/769-113/000-038](http://www.wago.com/769-113/000-038)



**Item no.: 769-113/000-039**

1-conductor female plug; 4 mm<sup>2</sup>; 13-pole; 4,00 mm<sup>2</sup>; green-yellow, blue, gray

[www.wago.com/769-113/000-039](http://www.wago.com/769-113/000-039)



**Item no.: 769-113/022-000**

1-conductor female plug; angled; 4 mm<sup>2</sup>; 13-pole; 4,00 mm<sup>2</sup>; gray

[www.wago.com/769-113/022-000](http://www.wago.com/769-113/022-000)



**Item no.: 769-114**

1-conductor female plug; 4 mm<sup>2</sup>; 14-pole; 4,00 mm<sup>2</sup>; gray

[www.wago.com/769-114](http://www.wago.com/769-114)



**Item no.: 769-114/000-006**

1-conductor female plug; 4 mm<sup>2</sup>; 14-pole; 4,00 mm<sup>2</sup>; blue

[www.wago.com/769-114/000-006](http://www.wago.com/769-114/000-006)



**Item no.: 769-114/000-036**

1-conductor female plug; 4 mm<sup>2</sup>; 14-pole; 4,00 mm<sup>2</sup>; gray, green-yellow

[www.wago.com/769-114/000-036](http://www.wago.com/769-114/000-036)



**Item no.: 769-114/000-037**

1-conductor female plug; 4 mm<sup>2</sup>; 14-pole; 4,00 mm<sup>2</sup>; green-yellow, gray

[www.wago.com/769-114/000-037](http://www.wago.com/769-114/000-037)



**Item no.: 769-114/000-038**

1-conductor female plug; 4 mm<sup>2</sup>; 14-pole; 4,00 mm<sup>2</sup>; gray, blue, green-yellow

[www.wago.com/769-114/000-038](http://www.wago.com/769-114/000-038)



**Item no.: 769-114/000-039**

1-conductor female plug; 4 mm<sup>2</sup>; 14-pole; 4,00 mm<sup>2</sup>; green-yellow, blue, gray

[www.wago.com/769-114/000-039](http://www.wago.com/769-114/000-039)



**Item no.: 769-114/022-000**

1-conductor female plug; angled; 4 mm<sup>2</sup>; 14-pole; 4,00 mm<sup>2</sup>; gray

[www.wago.com/769-114/022-000](http://www.wago.com/769-114/022-000)



**Item no.: 769-115**

1-conductor female plug; 4 mm<sup>2</sup>; 15-pole; 4,00 mm<sup>2</sup>; gray

[www.wago.com/769-115](http://www.wago.com/769-115)



**Item no.: 769-115/000-036**

1-conductor female plug; 4 mm<sup>2</sup>; 15-pole; 4,00 mm<sup>2</sup>; gray, green-yellow

[www.wago.com/769-115/000-036](http://www.wago.com/769-115/000-036)



**Item no.: 769-115/000-037**

1-conductor female plug; 4 mm<sup>2</sup>; 15-pole; 4,00 mm<sup>2</sup>; green-yellow, gray

[www.wago.com/769-115/000-037](http://www.wago.com/769-115/000-037)

Subject to changes. Please also observe the further product documentation!

WAGO Kontakttechnik GmbH & Co. KG

Hansastr. 27

32423 Minden

Phone: +49571 887-0 | Fax: +49571 887-169

Email: [info.de@wago.com](mailto:info.de@wago.com) | Web: [www.wago.com](http://www.wago.com)

Do you have any questions about our products?

We are always happy to take your call at +49 (571) 887-44222.



**Item no.: 769-115/000-038**  
1-conductor female plug; 4 mm<sup>2</sup>; 15-pole; 4,00 mm<sup>2</sup>; gray, blue, green-yellow

[www.wago.com/769-115/000-038](http://www.wago.com/769-115/000-038)



**Item no.: 769-115/000-039**  
1-conductor female plug; 4 mm<sup>2</sup>; 15-pole; 4,00 mm<sup>2</sup>; green-yellow, blue, gray

[www.wago.com/769-115/000-039](http://www.wago.com/769-115/000-039)



**Item no.: 769-115/022-000**  
1-conductor female plug; angled; 4 mm<sup>2</sup>; 15-pole; 4,00 mm<sup>2</sup>; gray

[www.wago.com/769-115/022-000](http://www.wago.com/769-115/022-000)



**Item no.: 769-121**  
2-conductor female connector; 4 mm<sup>2</sup>; 1-pole; 4,00 mm<sup>2</sup>; gray

[www.wago.com/769-121](http://www.wago.com/769-121)



**Item no.: 769-121/000-016**  
2-conductor female connector; 4 mm<sup>2</sup>; 1-pole; 4,00 mm<sup>2</sup>; green-yellow

[www.wago.com/769-121/000-016](http://www.wago.com/769-121/000-016)



**Item no.: 769-122**  
2-conductor female connector; 4 mm<sup>2</sup>; 2-pole; 4,00 mm<sup>2</sup>; gray

[www.wago.com/769-122](http://www.wago.com/769-122)



**Item no.: 769-123**  
2-conductor female connector; 4 mm<sup>2</sup>; 3-pole; 4,00 mm<sup>2</sup>; gray

[www.wago.com/769-123](http://www.wago.com/769-123)



**Item no.: 769-124**  
2-conductor female connector; 4 mm<sup>2</sup>; 4-pole; 4,00 mm<sup>2</sup>; gray

[www.wago.com/769-124](http://www.wago.com/769-124)



**Item no.: 769-125**  
2-conductor female connector; 4 mm<sup>2</sup>; 5-pole; 4,00 mm<sup>2</sup>; gray

[www.wago.com/769-125](http://www.wago.com/769-125)



**Item no.: 769-126**  
2-conductor female connector; 4 mm<sup>2</sup>; 6-pole; 4,00 mm<sup>2</sup>; gray

[www.wago.com/769-126](http://www.wago.com/769-126)



**Item no.: 769-127**  
2-conductor female connector; 4 mm<sup>2</sup>; 7-pole; 4,00 mm<sup>2</sup>; gray

[www.wago.com/769-127](http://www.wago.com/769-127)



**Item no.: 769-128**  
2-conductor female connector; 4 mm<sup>2</sup>; 8-pole; 4,00 mm<sup>2</sup>; gray

[www.wago.com/769-128](http://www.wago.com/769-128)



**Item no.: 769-129**  
2-conductor female connector; 4 mm<sup>2</sup>; 9-pole; 4,00 mm<sup>2</sup>; gray

[www.wago.com/769-129](http://www.wago.com/769-129)



**Item no.: 769-130**  
2-conductor female connector; 4 mm<sup>2</sup>; 10-pole; 4,00 mm<sup>2</sup>; gray

[www.wago.com/769-130](http://www.wago.com/769-130)



**Item no.: 769-131**  
2-conductor female connector; 4 mm<sup>2</sup>; 11-pole; 4,00 mm<sup>2</sup>; gray

[www.wago.com/769-131](http://www.wago.com/769-131)



**Item no.: 769-132**  
2-conductor female connector; 4 mm<sup>2</sup>; 12-pole; 4,00 mm<sup>2</sup>; gray

[www.wago.com/769-132](http://www.wago.com/769-132)



**Item no.: 769-133**  
2-conductor female connector; 4 mm<sup>2</sup>; 13-pole; 4,00 mm<sup>2</sup>; gray

[www.wago.com/769-133](http://www.wago.com/769-133)

Subject to changes. Please also observe the further product documentation!



**Item no.: 769-134**  
2-conductor female connector; 4 mm<sup>2</sup>; 14-pole; 4,00 mm<sup>2</sup>; gray

[www.wago.com/769-134](http://www.wago.com/769-134)



**Item no.: 769-135**  
2-conductor female connector; 4 mm<sup>2</sup>; 15-pole; 4,00 mm<sup>2</sup>; gray

[www.wago.com/769-135](http://www.wago.com/769-135)

#### Insulation stop



**Item no.: 769-470**  
Insulation stop; 0.08 - 0.2 mm<sup>2</sup> "s" (0.14 mm<sup>2</sup> "f-st"); 5 pieces/strip; white

[www.wago.com/769-470](http://www.wago.com/769-470)



**Item no.: 769-471**  
Insulation stop; 0.25 - 0.5 mm<sup>2</sup>; 5 pieces/strip; light gray

[www.wago.com/769-471](http://www.wago.com/769-471)

**Item no.: 769-472**  
Insulation stop; 0.75 - 1 mm<sup>2</sup>; 5 pieces/strip; dark gray

[www.wago.com/769-472](http://www.wago.com/769-472)

#### ferrule



**Item no.: 216-101**  
Ferrule; Sleeve for 0.5 mm<sup>2</sup> / AWG 22; uninsulated; electro-tin plated

[www.wago.com/216-101](http://www.wago.com/216-101)



**Item no.: 216-102**  
Ferrule; Sleeve for 0.75 mm<sup>2</sup> / AWG 20; uninsulated; electro-tin plated

[www.wago.com/216-102](http://www.wago.com/216-102)



**Item no.: 216-103**  
Ferrule; Sleeve for 1 mm<sup>2</sup> / AWG 18; uninsulated; electro-tin plated

[www.wago.com/216-103](http://www.wago.com/216-103)



**Item no.: 216-104**  
Ferrule; Sleeve for 1.5 mm<sup>2</sup> / AWG 16; uninsulated; electro-tin plated

[www.wago.com/216-104](http://www.wago.com/216-104)

**Item no.: 216-201**  
Ferrule; Sleeve for 0.5 mm<sup>2</sup> / 20 AWG; insulated; electro-tin plated; white

[www.wago.com/216-201](http://www.wago.com/216-201)



**Item no.: 216-202**  
Ferrule; Sleeve for 0.75 mm<sup>2</sup> / 18 AWG; insulated; electro-tin plated; gray

[www.wago.com/216-202](http://www.wago.com/216-202)

**Item no.: 216-203**  
Ferrule; Sleeve for 1 mm<sup>2</sup> / AWG 18; insulated; electro-tin plated; red

[www.wago.com/216-203](http://www.wago.com/216-203)

**Item no.: 216-204**  
Ferrule; Sleeve for 1.5 mm<sup>2</sup> / AWG 16; insulated; electro-tin plated; black

[www.wago.com/216-204](http://www.wago.com/216-204)



**Item no.: 216-206**  
Ferrule; Sleeve for 2.5 mm<sup>2</sup> / AWG 14; insulated; electro-tin plated; blue

[www.wago.com/216-206](http://www.wago.com/216-206)

**Item no.: 216-301**  
Ferrule; Sleeve for 0.25 mm<sup>2</sup> / AWG 24; insulated; electro-tin plated; yellow

[www.wago.com/216-301](http://www.wago.com/216-301)



**Item no.: 216-302**  
Ferrule; Sleeve for 0.34 mm<sup>2</sup> / 22 AWG; insulated; electro-tin plated; green

[www.wago.com/216-302](http://www.wago.com/216-302)















#### General accessories



**Item no.: 769-438**  
Pin cover; with marker slot for miniature WSB; gray

[www.wago.com/769-438](http://www.wago.com/769-438)

Subject to changes. Please also observe the further product documentation!

	<b>Item no.: 769-439</b> Pin cover; with marker slot for miniature WSB; orange	<a href="http://www.wago.com/769-439">www.wago.com/769-439</a>
	<b>Item no.: 769-501</b> Start module for 1-conductor female connector; with integrated end plate; 4 mm <sup>2</sup> ; 1-pole; 4,00 mm <sup>2</sup> ; gray	<a href="http://www.wago.com/769-501">www.wago.com/769-501</a>
	<b>Item no.: 769-501/000-006</b> Start module for 1-conductor female connector; 4 mm <sup>2</sup> ; 1-pole; 4,00 mm <sup>2</sup> ; blue	<a href="http://www.wago.com/769-501/000-006">www.wago.com/769-501/000-006</a>
	<b>Item no.: 769-501/000-016</b> Start module for 1-conductor female connector; with integrated end plate; 4 mm <sup>2</sup> ; 1-pole; 4,00 mm <sup>2</sup> ; green-yellow	<a href="http://www.wago.com/769-501/000-016">www.wago.com/769-501/000-016</a>
	<b>Item no.: 769-502</b> Center module for 1-conductor female connector; 4 mm <sup>2</sup> ; 1-pole; 4,00 mm <sup>2</sup> ; gray	<a href="http://www.wago.com/769-502">www.wago.com/769-502</a>
	<b>Item no.: 769-502/000-006</b> Center module for 1-conductor female connector; 4 mm <sup>2</sup> ; 1-pole; 4,00 mm <sup>2</sup> ; blue	<a href="http://www.wago.com/769-502/000-006">www.wago.com/769-502/000-006</a>
	<b>Item no.: 769-502/000-016</b> Center module for 1-conductor female connector; 4 mm <sup>2</sup> ; 1-pole; 4,00 mm <sup>2</sup> ; green-yellow	<a href="http://www.wago.com/769-502/000-016">www.wago.com/769-502/000-016</a>
	<b>Item no.: 769-503</b> End module for 1-conductor female connector; 4 mm <sup>2</sup> ; 1-pole; 4,00 mm <sup>2</sup> ; gray	<a href="http://www.wago.com/769-503">www.wago.com/769-503</a>
	<b>Item no.: 769-503/000-006</b> End module for 1-conductor female connector; 4 mm <sup>2</sup> ; 1-pole; 4,00 mm <sup>2</sup> ; blue	<a href="http://www.wago.com/769-503/000-006">www.wago.com/769-503/000-006</a>
	<b>Item no.: 769-503/000-016</b> End module for 1-conductor female connector; 4 mm <sup>2</sup> ; 1-pole; 4,00 mm <sup>2</sup> ; green-yellow	<a href="http://www.wago.com/769-503/000-016">www.wago.com/769-503/000-016</a>
	<b>Item no.: 769-504</b> Start module for 2-conductor female connector; with integrated end plate; 4 mm <sup>2</sup> ; 1-pole; 4,00 mm <sup>2</sup> ; gray	<a href="http://www.wago.com/769-504">www.wago.com/769-504</a>
	<b>Item no.: 769-504/000-006</b> Start module for 2-conductor female connector; with integrated end plate; 4 mm <sup>2</sup> ; 1-pole; 4,00 mm <sup>2</sup> ; blue	<a href="http://www.wago.com/769-504/000-006">www.wago.com/769-504/000-006</a>
	<b>Item no.: 769-504/000-016</b> Start module for 2-conductor female connector; 4 mm <sup>2</sup> ; 1-pole; 4,00 mm <sup>2</sup> ; green-yellow	<a href="http://www.wago.com/769-504/000-016">www.wago.com/769-504/000-016</a>
	<b>Item no.: 769-505</b> Center module for 2-conductor female connector; 4 mm <sup>2</sup> ; 1-pole; 4,00 mm <sup>2</sup> ; gray	<a href="http://www.wago.com/769-505">www.wago.com/769-505</a>
	<b>Item no.: 769-505/000-006</b> Center module for 2-conductor female connector; 4 mm <sup>2</sup> ; 1-pole; 4,00 mm <sup>2</sup> ; blue	<a href="http://www.wago.com/769-505/000-006">www.wago.com/769-505/000-006</a>

Subject to changes. Please also observe the further product documentation!













	<b>Item no.: 769-505/000-016</b> Center module for 2-conductor female connector; 4 mm <sup>2</sup> ; 1-pole; 4,00 mm <sup>2</sup> ; green-yellow	<a href="http://www.wago.com/769-505/000-016">www.wago.com/769-505/000-016</a>
	<b>Item no.: 769-506</b> End module for 2-conductor female connector; 4 mm <sup>2</sup> ; 1-pole; 4,00 mm <sup>2</sup> ; gray	<a href="http://www.wago.com/769-506">www.wago.com/769-506</a>
	<b>Item no.: 769-506/000-006</b> End module for 2-conductor female connector; 4 mm <sup>2</sup> ; 1-pole; 4,00 mm <sup>2</sup> ; blue	<a href="http://www.wago.com/769-506/000-006">www.wago.com/769-506/000-006</a>
	<b>Item no.: 769-506/000-016</b> End module for 2-conductor female connector; 4 mm <sup>2</sup> ; 1-pole; 4,00 mm <sup>2</sup> ; green-yellow	<a href="http://www.wago.com/769-506/000-016">www.wago.com/769-506/000-016</a>
	<b>Item no.: 769-512</b> Start module for 1-conductor female connector; angled; 4 mm <sup>2</sup> ; 1-pole; 4,00 mm <sup>2</sup> ; gray	<a href="http://www.wago.com/769-512">www.wago.com/769-512</a>
	<b>Item no.: 769-512/000-006</b> Start module for 1-conductor female connector; angled; 4 mm <sup>2</sup> ; 1-pole; 4,00 mm <sup>2</sup> ; blue	<a href="http://www.wago.com/769-512/000-006">www.wago.com/769-512/000-006</a>
	<b>Item no.: 769-512/000-016</b> Start module for 1-conductor female connector; angled; 4 mm <sup>2</sup> ; 1-pole; 4,00 mm <sup>2</sup> ; green-yellow	<a href="http://www.wago.com/769-512/000-016">www.wago.com/769-512/000-016</a>
	<b>Item no.: 769-513</b> Center module for 1-conductor female connector; angled; 4 mm <sup>2</sup> ; 1-pole; 4,00 mm <sup>2</sup> ; gray	<a href="http://www.wago.com/769-513">www.wago.com/769-513</a>
	<b>Item no.: 769-513/000-006</b> Center module for 1-conductor female connector; angled; 4 mm <sup>2</sup> ; 1-pole; 4,00 mm <sup>2</sup> ; blue	<a href="http://www.wago.com/769-513/000-006">www.wago.com/769-513/000-006</a>
	<b>Item no.: 769-513/000-016</b> Center module for 1-conductor female connector; angled; 4 mm <sup>2</sup> ; 1-pole; 4,00 mm <sup>2</sup> ; green-yellow	<a href="http://www.wago.com/769-513/000-016">www.wago.com/769-513/000-016</a>
	<b>Item no.: 769-515</b> End module for 1-conductor female connector; angled; 4 mm <sup>2</sup> ; 1-pole; 4,00 mm <sup>2</sup> ; gray	<a href="http://www.wago.com/769-515">www.wago.com/769-515</a>
	<b>Item no.: 769-515/000-006</b> End module for 1-conductor female connector; angled; 4 mm <sup>2</sup> ; 1-pole; 4,00 mm <sup>2</sup> ; blue	<a href="http://www.wago.com/769-515/000-006">www.wago.com/769-515/000-006</a>
	<b>Item no.: 769-515/000-016</b> End module for 1-conductor female connector; angled; 4 mm <sup>2</sup> ; 1-pole; 4,00 mm <sup>2</sup> ; green-yellow	<a href="http://www.wago.com/769-515/000-016">www.wago.com/769-515/000-016</a>

**Protective Warning Marker**









	<b>Item no.: 280-415</b> Protective warning marker; with high-voltage symbol, black; for 5 terminal blocks; yellow	<a href="http://www.wago.com/280-415">www.wago.com/280-415</a>
--	---	--

**Jumper**

Subject to changes. Please also observe the further product documentation!







	<b>Item no.: 249-123</b> Push-in type wire jumper; insulated; wire length 180 mm; Conductor cross section 0.75 mm <sup>2</sup>	<a href="http://www.wago.com/249-123">www.wago.com/249-123</a>
	<b>Item no.: 249-125</b> Push-in type wire jumper; insulated; wire length 60 mm; Conductor cross section 0.75 mm <sup>2</sup>	<a href="http://www.wago.com/249-125">www.wago.com/249-125</a>
	<b>Item no.: 249-126</b> Push-in type wire jumper; insulated; wire length 110 mm; Conductor cross section 0.75 mm <sup>2</sup>	<a href="http://www.wago.com/249-126">www.wago.com/249-126</a>
	<b>Item no.: 249-127</b> Push-in type wire jumper; insulated; wire length 250 mm; Conductor cross section 0.75 mm <sup>2</sup>	<a href="http://www.wago.com/249-127">www.wago.com/249-127</a>
	<b>Item no.: 280-402</b> Adjacent jumper; insulated; IN = IN terminal block; gray	<a href="http://www.wago.com/280-402">www.wago.com/280-402</a>
	<b>Item no.: 280-409</b> Alternate jumper; insulated; IN = IN terminal block; gray	<a href="http://www.wago.com/280-409">www.wago.com/280-409</a>
	<b>Item no.: 780-452</b> Staggered jumper; insulated; from 1 to 2; Spacing: 5 mm; suitable for 2-conductor female plugs; gray	<a href="http://www.wago.com/780-452">www.wago.com/780-452</a>
	<b>Item no.: 780-453</b> Staggered jumper; insulated; from 1 to 3; Spacing: 5 mm; suitable for 2-conductor female plugs; gray	<a href="http://www.wago.com/780-453">www.wago.com/780-453</a>
	<b>Item no.: 780-454</b> Staggered jumper; insulated; from 1 to 4; Spacing: 5 mm; suitable for 2-conductor female plugs; gray	<a href="http://www.wago.com/780-454">www.wago.com/780-454</a>
	<b>Item no.: 780-455</b> Staggered jumper; insulated; from 1 to 5; Spacing: 5 mm; suitable for 2-conductor female plugs; gray	<a href="http://www.wago.com/780-455">www.wago.com/780-455</a>
	<b>Item no.: 780-456</b> Staggered jumper; insulated; from 1 to 6; Spacing: 5 mm; suitable for 2-conductor female plugs; gray	<a href="http://www.wago.com/780-456">www.wago.com/780-456</a>
	<b>Item no.: 780-457</b> Staggered jumper; insulated; from 1 to 7; Spacing: 5 mm; suitable for 2-conductor female plugs; gray	<a href="http://www.wago.com/780-457">www.wago.com/780-457</a>
	<b>Item no.: 780-458</b> Staggered jumper; insulated; from 1 to 8; Spacing: 5 mm; suitable for 2-conductor female plugs; gray	<a href="http://www.wago.com/780-458">www.wago.com/780-458</a>
<b>Carrier rail</b>		
	<b>Item no.: 210-112</b> Steel carrier rail; 35 x 7.5 mm; 1 mm thick; 2 m long; slotted; according to EN 60715; "Hole width 25 mm	<a href="http://www.wago.com/210-112">www.wago.com/210-112</a>
	<b>Item no.: 210-113</b> Steel carrier rail; 35 x 7.5 mm; 1 mm thick; 2 m long; unslotted; according to EN 60715	<a href="http://www.wago.com/210-113">www.wago.com/210-113</a>
	<b>Item no.: 210-114</b> Steel carrier rail; 35 x 15 mm; 1.5 mm thick; 2 m long; unslotted; similar to EN 60715	<a href="http://www.wago.com/210-114">www.wago.com/210-114</a>
	<b>Item no.: 210-115</b> Steel carrier rail; 35 x 7.5 mm; 1 mm thick; 2 m long; slotted; according to EN 60715; "Hole width 18 mm	<a href="http://www.wago.com/210-115">www.wago.com/210-115</a>

Subject to changes. Please also observe the further product documentation!

	<b>Item no.: 210-118</b> Steel carrier rail; 35 x 15 mm; 2.3 mm thick; 2 m long; unslotted; according to EN 60715	<a href="http://www.wago.com/210-118">www.wago.com/210-118</a>
	<b>Item no.: 210-196</b> Aluminum carrier rail; 35 x 8.2 mm; 1.6 mm thick; 2 m long; unslotted; similar to EN 60715; silver-colored	<a href="http://www.wago.com/210-196">www.wago.com/210-196</a>
	<b>Item no.: 210-197</b> Steel carrier rail; 35 x 15 mm; 1.5 mm thick; 2 m long; slotted; similar to EN 60715	<a href="http://www.wago.com/210-197">www.wago.com/210-197</a>
	<b>Item no.: 210-198</b> Copper carrier rail; 35 x 15 mm; 2.3 mm thick; 2 m long; unslotted; according to EN 60715; copper-colored	<a href="http://www.wago.com/210-198">www.wago.com/210-198</a>
	<b>Item no.: 210-504</b> Steel carrier rail; 35 x 7.5 mm; 1 mm thick; 2 m long; slotted; galvanized; according to EN 60715	<a href="http://www.wago.com/210-504">www.wago.com/210-504</a>
	<b>Item no.: 210-505</b> Steel carrier rail; 35 x 7.5 mm; 1 mm thick; 2 m long; unslotted; galvanized; according to EN 60715	<a href="http://www.wago.com/210-505">www.wago.com/210-505</a>
	<b>Item no.: 210-506</b> Steel carrier rail; 35 x 15 mm; 1.5 mm thick; 2 m long; unslotted; galvanized; similar to EN 60715	<a href="http://www.wago.com/210-506">www.wago.com/210-506</a>
	<b>Item no.: 210-508</b> Steel carrier rail; 35 x 15 mm; 1.5 mm thick; 2 m long; slotted; galvanized; similar to EN 60715	<a href="http://www.wago.com/210-508">www.wago.com/210-508</a>
<b>Marking accessories</b>		
	<b>Item no.: 2009-145</b> Mini-WSB Inline; for Smart Printer; 1700 pieces on roll; stretchable 5 - 5.2 mm; plain; snap-on type; white	<a href="http://www.wago.com/2009-145">www.wago.com/2009-145</a>
	<b>Item no.: 2009-145/000-002</b> Mini-WSB Inline; for Smart Printer; 1700 pieces on roll; stretchable 5 - 5.2 mm; plain; snap-on type; white	<a href="http://www.wago.com/2009-145/000-002">www.wago.com/2009-145/000-002</a>
	<b>Item no.: 2009-145/000-005</b> Mini-WSB Inline; for Smart Printer; 1700 pieces on roll; stretchable 5 - 5.2 mm; plain; snap-on type; red	<a href="http://www.wago.com/2009-145/000-005">www.wago.com/2009-145/000-005</a>
	<b>Item no.: 2009-145/000-006</b> Mini-WSB Inline; for Smart Printer; 1700 pieces on roll; stretchable 5 - 5.2 mm; plain; snap-on type; blue	<a href="http://www.wago.com/2009-145/000-006">www.wago.com/2009-145/000-006</a>
	<b>Item no.: 2009-145/000-007</b> Mini-WSB Inline; for Smart Printer; 1700 pieces on roll; stretchable 5 - 5.2 mm; plain; snap-on type; white	<a href="http://www.wago.com/2009-145/000-007">www.wago.com/2009-145/000-007</a>
	<b>Item no.: 2009-145/000-012</b> Mini-WSB Inline; for Smart Printer; 1700 pieces on roll; stretchable 5 - 5.2 mm; plain; snap-on type; orange	<a href="http://www.wago.com/2009-145/000-012">www.wago.com/2009-145/000-012</a>
	<b>Item no.: 2009-145/000-023</b> Mini-WSB Inline; for Smart Printer; 1700 pieces on roll; stretchable 5 - 5.2 mm; plain; snap-on type; green	<a href="http://www.wago.com/2009-145/000-023">www.wago.com/2009-145/000-023</a>

Subject to changes. Please also observe the further product documentation!



	<p><b>Item no.: 2009-145/000-024</b> Mini-WSB Inline; for Smart Printer; 1700 pieces on roll; stretchable 5 - 5.2 mm; plain; snap-on type; violet</p>	<a href="http://www.wago.com/2009-145/000-024">www.wago.com/2009-145/000-024</a>
	<p><b>Item no.: 248-501</b> Miniature WSB Quick marking system; plain; Marker width 5 mm; 10 strips with 10 markers per card</p>	<a href="http://www.wago.com/248-501">www.wago.com/248-501</a>
	<p><b>Item no.: 248-501/000-002</b> Mini-WSB marking card; as card; not stretchable; plain; snap-on type; yellow</p>	<a href="http://www.wago.com/248-501/000-002">www.wago.com/248-501/000-002</a>
	<p><b>Item no.: 248-501/000-005</b> Mini-WSB marking card; as card; not stretchable; plain; snap-on type; red</p>	<a href="http://www.wago.com/248-501/000-005">www.wago.com/248-501/000-005</a>
	<p><b>Item no.: 248-501/000-006</b> Mini-WSB marking card; as card; not stretchable; plain; snap-on type; blue</p>	<a href="http://www.wago.com/248-501/000-006">www.wago.com/248-501/000-006</a>
	<p><b>Item no.: 248-501/000-007</b> Mini-WSB marking card; as card; not stretchable; plain; snap-on type; gray</p>	<a href="http://www.wago.com/248-501/000-007">www.wago.com/248-501/000-007</a>
	<p><b>Item no.: 248-501/000-012</b> Mini-WSB marking card; as card; not stretchable; plain; snap-on type; orange</p>	<a href="http://www.wago.com/248-501/000-012">www.wago.com/248-501/000-012</a>
	<p><b>Item no.: 248-501/000-017</b> Mini-WSB marking card; as card; not stretchable; plain; snap-on type; light green</p>	<a href="http://www.wago.com/248-501/000-017">www.wago.com/248-501/000-017</a>
	<p><b>Item no.: 248-501/000-023</b> Mini-WSB marking card; as card; not stretchable; plain; snap-on type; green</p>	<a href="http://www.wago.com/248-501/000-023">www.wago.com/248-501/000-023</a>
	<p><b>Item no.: 248-501/000-024</b> Mini-WSB marking card; as card; not stretchable; plain; snap-on type; violet</p>	<a href="http://www.wago.com/248-501/000-024">www.wago.com/248-501/000-024</a>
<b>assembling</b>		
	<p><b>Item no.: 209-106</b> Mounting carrier; for isolated mounting on DIN 35 rails; gray</p>	<a href="http://www.wago.com/209-106">www.wago.com/209-106</a>
<b>Test Accessories</b>		
	<p><b>Item no.: 210-136</b> Test plug; 2 mm Ø; with 500 mm cable; red</p>	<a href="http://www.wago.com/210-136">www.wago.com/210-136</a>
	<p><b>Item no.: 210-137</b> Test plug; 2.3 mm Ø; with 500 mm cable; yellow</p>	<a href="http://www.wago.com/210-137">www.wago.com/210-137</a>
	<p><b>Item no.: 280-404</b> Test plug adapter; 5 mm wide; for test plug 210-137 (2.3 mm Ø); suitable for 1.5 mm<sup>2</sup> - 4 mm<sup>2</sup> tbs; gray</p>	<a href="http://www.wago.com/280-404">www.wago.com/280-404</a>

Subject to changes. Please also observe the further product documentation!

**Item no.: 280-418**

Test plug module; modular; suitable for all WAGO 280 and 780 Series rail-mounted terminal blocks with jumper slots in the current bar; gray

[www.wago.com/280-418](http://www.wago.com/280-418)

**Item no.: 280-419**

Spacer module; modular; bridging commoned terminal blocks; gray

[www.wago.com/280-419](http://www.wago.com/280-419)

## Downloads

### Documentation

#### Additional Information

Technical explanations	Apr 3, 2019	pdf 2.1 MB	Download
------------------------	-------------	---------------	----------

## CAD/CAE-Data

### CAD data

2D/3D Models 769-218/281-410	URL	Download
------------------------------	-----	----------

### CAE data

EPLAN Data Portal 769-218/281-410	URL	Download
-----------------------------------	-----	----------

WSCAD Universe 769-218/281-410	URL	Download
--------------------------------	-----	----------

## Installation Notes

### Assembly

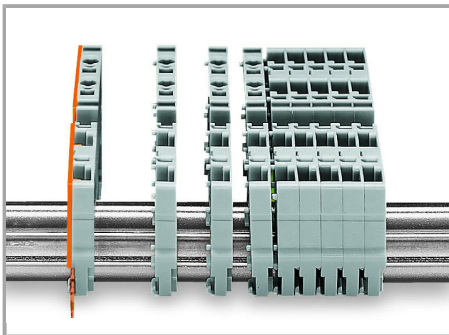

Snap individual carrier terminal blocks onto the carrier rail and slide together.

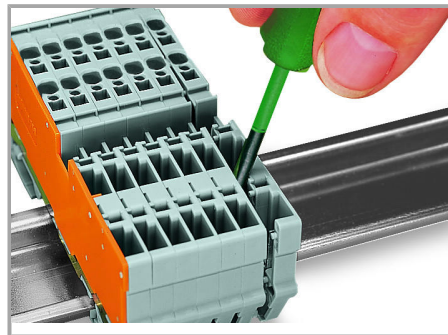

Open the assembly by laterally sliding a block via operating tool and remove terminal block via release lever.

Subject to changes. Please also observe the further product documentation!

### Inserting a conductor

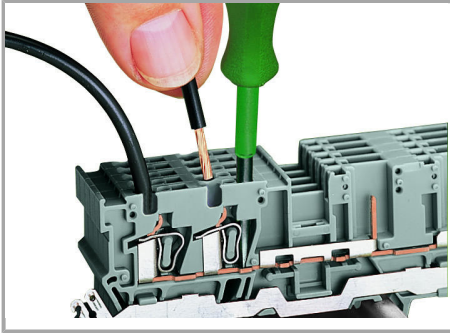

### CAGE CLAMP® connection

Carrier terminal block: Insert/remove conductor via operating tool (3.5 x 0.5 mm blade).

### Jumpered

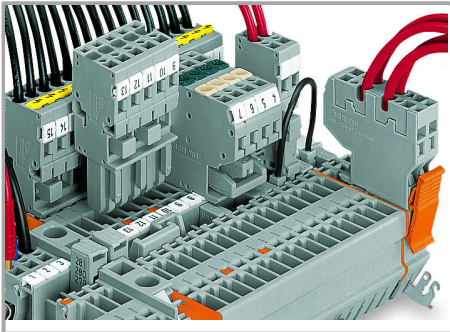

Commoning with adjacent or staggered jumpers –

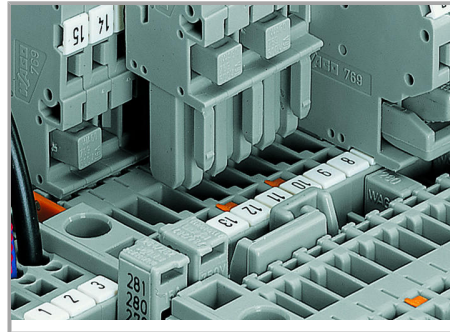

Commoning carrier terminal blocks via staggered jumpers.

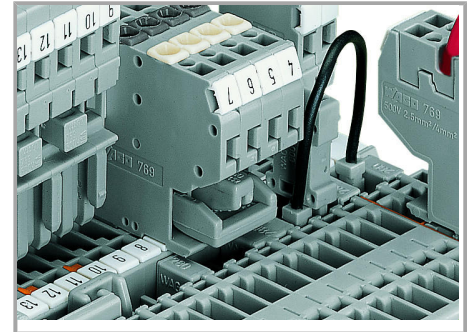

Commoning a 2-conductor female plug via staggered jumper and carrier terminal blocks via adjacent jumpers.

push jumpers down until fully inserted.

Subject to changes. Please also observe the further product documentation!

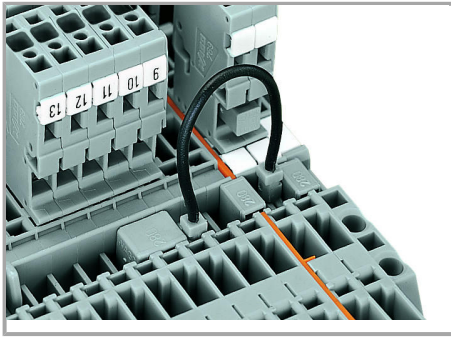

Commoning carrier terminal blocks via push-in type wire jumpers or adjacent jumpers – even over an intermediate plate.

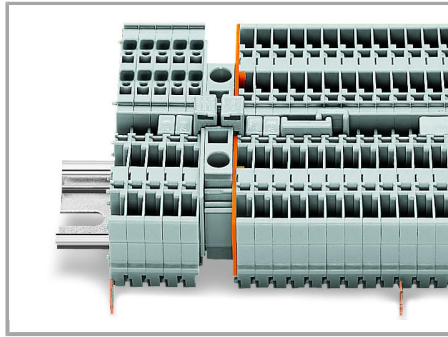

Commoning “supply terminal blocks” (up to 10 mm<sup>2</sup>/8 AWG) with carrier terminal blocks via step-down jumpers.

### Testing

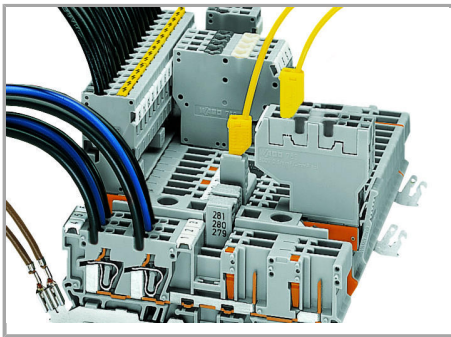

Testing via 2 or 2.3 mm Ø test plugs.

### Coding

Subject to changes. Please also observe the further product documentation!

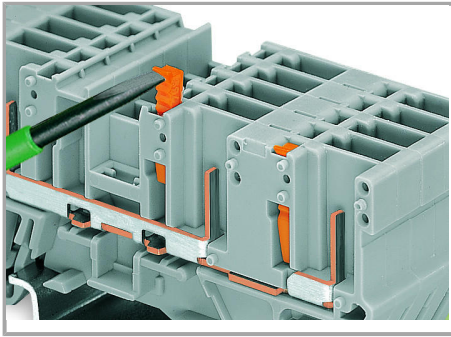

Snap coding pin in proper direction on carrier terminal block.

Shown: Coding pin removal from carrier terminal block.

#### Locking

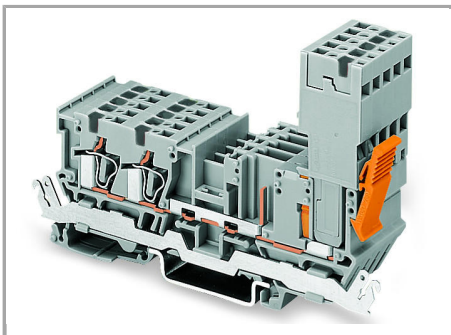

Female plug secured with locking lever on the terminal block side.

Subject to changes. Please also observe the further product documentation!

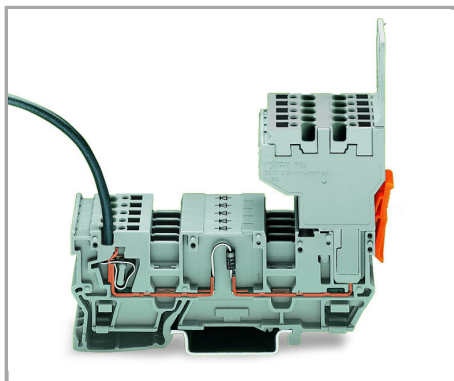

2-conductor female plug

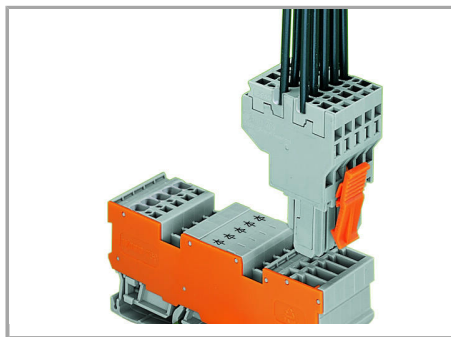

1-conductor/1-pin diode carrier terminal block with two jumper positions

Diode carrier terminal blocks can be commoned via 280 and 780 Series Jumpers and tested using a 280 Series Test Plug Adapter.

2-conductor female plug

## Product family

### X-COM

[Learn more about the product family.](#)

[Show all products from the family](#)

Subject to changes. Please also observe the further product documentation!