

Data sheet | Item number: 769-208/281-411

2-pin component carrier block; with 2 jumper positions; with diode 1N4007; anode, right side; for DIN-rail 35 x 15 and 35 x 7.5; 4 mm²; gray

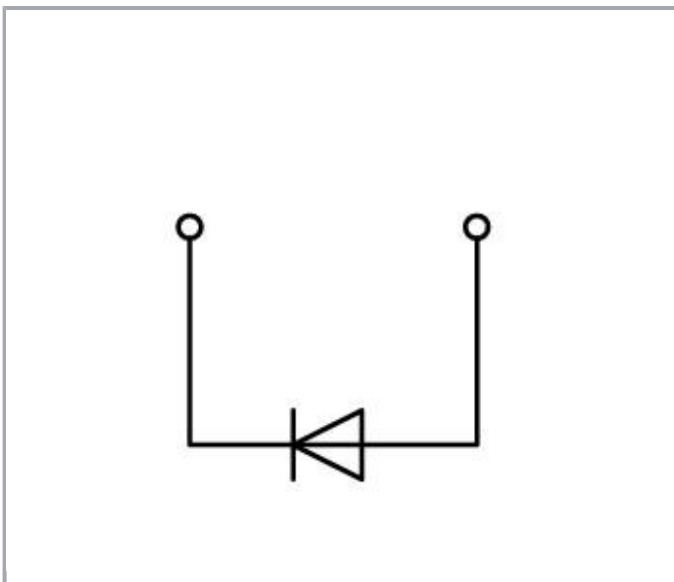

www.wago.com/769-208/281-411

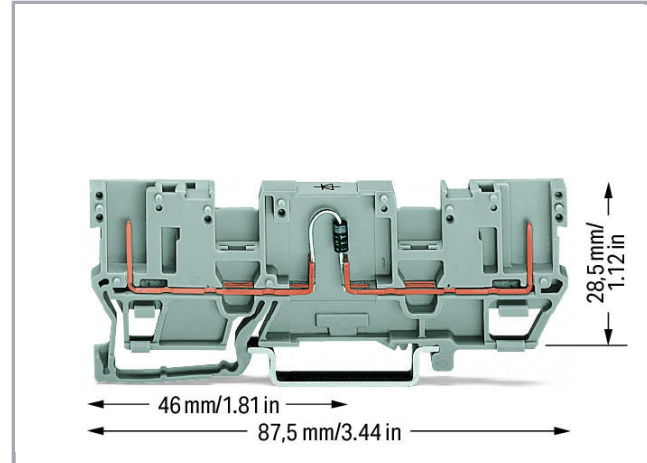
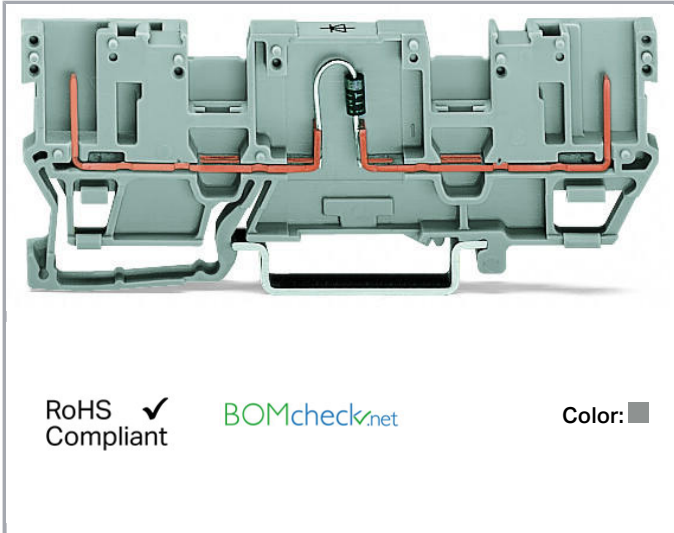

Data

Electrical data

Nominal voltage	250 V
Reverse voltage	1,000 V

Subject to changes. Please also observe the further product documentation!

WAGO Kontakttechnik GmbH & Co. KG
Hansastr. 27
32423 Minden
Phone: +49571 887-0 | Fax: +49571 887-169
Email: info.de@wago.com | Web: www.wago.com

Do you have any questions about our products?
We are always happy to take your call at +49 (571) 887-44222.

Ratings per IEC/EN 60664-1

Rated current	0.5 A
---------------	-------

Connection data

Total number of potentials	1
Number of levels	1
Type of wiring	Front-entry wiring

Geometrical Data

Width	5 mm / 0.197 inch
Height from upper-edge of DIN-35 rail	28,5 mm / 1.122 inch
Depth	87,5 mm / 3.445 inch

Mechanical data

Design	horizontal
Type of mounting	DIN-35 rail
Marking level	Center marking

Material Data

Color	gray
Insulating material	Polyamide 66 (PA 66)
Fire load	0.17 MJ
Weight	7.7 g

Commercial data

Product Group	18 (X-COM-System)
Packaging type	BOX
Country of origin	DE
GTIN	4045454198374
Customs Tariff No.	85369010000

Approvals / Certificates

Country specific Approvals

Logo	Approval	Additional Approval Text	Certificate name
	CCA	EN 60947	NTR NL-

Subject to changes. Please also observe the further product documentation!



DEKRA Certification B.V.

7626



CSA
DEKRA Certification B.V.

C22.2 No. 158

1101144



KEMA/KEUR
DEKRA Certification B.V.

EN 60947

2190419.01

Ship Approvals

Logo	Approval	Additional Approval Text	Certificate name
	ABS American Bureau of Shipping	EN 60947	20- HG1941090- PDA
	DNV GL Det Norske Veritas, Germanischer Lloyd	-	TAE00001V2

Counterpart

Compatible products

Carrier rail



Item no.: 210-112

Steel carrier rail; 35 x 7.5 mm; 1 mm thick; 2 m long; slotted; according to EN 60715; "Hole width 25 mm" www.wago.com/210-112

Item no.: 210-113

Subject to changes. Please also observe the further product documentation!

Steel carrier rail; 35 x 7.5 mm; 1 mm thick; 2 m long; unslotted; according to EN 60715

www.wago.com/210-113

Item no.: 210-114

Steel carrier rail; 35 x 15 mm; 1.5 mm thick; 2 m long; unslotted; similar to EN 60715

www.wago.com/210-114

Item no.: 210-115

Steel carrier rail; 35 x 7.5 mm; 1 mm thick; 2 m long; slotted; according to EN 60715; "Hole width 18 mm

www.wago.com/210-115

Item no.: 210-118

Steel carrier rail; 35 x 15 mm; 2.3 mm thick; 2 m long; unslotted; according to EN 60715

www.wago.com/210-118

Item no.: 210-196

Aluminum carrier rail; 35 x 8.2 mm; 1.6 mm thick; 2 m long; unslotted; similar to EN 60715; silver-colored

www.wago.com/210-196



Item no.: 210-197

Steel carrier rail; 35 x 15 mm; 1.5 mm thick; 2 m long; slotted; similar to EN 60715

www.wago.com/210-197



Item no.: 210-198

Copper carrier rail; 35 x 15 mm; 2.3 mm thick; 2 m long; unslotted; according to EN 60715; copper-colored

www.wago.com/210-198



Item no.: 210-504

Steel carrier rail; 35 x 7.5 mm; 1 mm thick; 2 m long; slotted; galvanized; according to EN 60715

www.wago.com/210-504

Item no.: 210-505

Steel carrier rail; 35 x 7.5 mm; 1 mm thick; 2 m long; unslotted; galvanized; according to EN 60715

www.wago.com/210-505

Item no.: 210-506

Steel carrier rail; 35 x 15 mm; 1.5 mm thick; 2 m long; unslotted; galvanized; similar to EN 60715

www.wago.com/210-506



Item no.: 210-508

Steel carrier rail; 35 x 15 mm; 1.5 mm thick; 2 m long; slotted; galvanized; similar to EN 60715

www.wago.com/210-508

Coding



Item no.: 769-435

Coding pin; for coding of female plugs; for carrier terminal blocks / male connectors; orange

www.wago.com/769-435

Female plug



Item no.: 769-101

1-conductor female plug; 4 mm²; 1-pole; 4,00 mm²; gray

www.wago.com/769-101



Item no.: 769-101/000-006

1-conductor female plug; 4 mm²; 1-pole; 4,00 mm²; blue

www.wago.com/769-101/000-006

Item no.: 769-101/000-016

1-conductor female plug; 4 mm²; 1-pole; 4,00 mm²; green-yellow

www.wago.com/769-101/000-016



Item no.: 769-101/022-000

1-conductor female plug; angled; 4 mm²; 1-pole; 4,00 mm²; gray

www.wago.com/769-101/022-000

Subject to changes. Please also observe the further product documentation!

WAGO Kontakttechnik GmbH & Co. KG

Hansastr. 27











32423 Minden

Phone: +49571 887-0 | Fax: +49571 887-169









Email: info.de@wago.com | Web: www.wago.com

Do you have any questions about our products?

We are always happy to take your call at +49 (571) 887-44222.

	<p>Item no.: 769-101/022-016 1-conductor female plug; angled; 4 mm²; 1-pole; 4,00 mm²; green-yellow</p>	www.wago.com/769-101/022-016
	<p>Item no.: 769-102 1-conductor female plug; 4 mm²; 2-pole; 4,00 mm²; gray</p>	www.wago.com/769-102
	<p>Item no.: 769-102/000-006 1-conductor female plug; 4 mm²; 2-pole; 4,00 mm²; blue</p>	www.wago.com/769-102/000-006
	<p>Item no.: 769-102/000-036 1-conductor female plug; 4 mm²; 2-pole; 4,00 mm²; gray, green-yellow</p>	www.wago.com/769-102/000-036
	<p>Item no.: 769-102/000-037 1-conductor female plug; 4 mm²; 2-pole; 4,00 mm²; green-yellow, gray</p>	www.wago.com/769-102/000-037
	<p>Item no.: 769-102/022-000 1-conductor female plug; angled; 4 mm²; 2-pole; 4,00 mm²; gray</p>	www.wago.com/769-102/022-000
	<p>Item no.: 769-103 1-conductor female plug; 4 mm²; 3-pole; 4,00 mm²; gray</p>	www.wago.com/769-103
	<p>Item no.: 769-103/000-006 1-conductor female plug; 4 mm²; 3-pole; 4,00 mm²; blue</p>	www.wago.com/769-103/000-006
	<p>Item no.: 769-103/000-036 1-conductor female plug; 4 mm²; 3-pole; 4,00 mm²; gray, green-yellow</p>	www.wago.com/769-103/000-036
	<p>Item no.: 769-103/000-037 1-conductor female plug; 4 mm²; 3-pole; 4,00 mm²; green-yellow, gray</p>	www.wago.com/769-103/000-037
	<p>Item no.: 769-103/000-038 1-conductor female plug; 4 mm²; 3-pole; 4,00 mm²; gray, blue, green-yellow</p>	www.wago.com/769-103/000-038
	<p>Item no.: 769-103/000-039 1-conductor female plug; 4 mm²; 3-pole; 4,00 mm²; green-yellow, blue, gray</p>	www.wago.com/769-103/000-039
	<p>Item no.: 769-103/022-000 1-conductor female plug; angled; 4 mm²; 3-pole; 4,00 mm²; gray</p>	www.wago.com/769-103/022-000
	<p>Item no.: 769-104 1-conductor female plug; 4 mm²; 4-pole; 4,00 mm²; gray</p>	www.wago.com/769-104

Subject to changes. Please also observe the further product documentation!

	<p>Item no.: 769-104/000-006 1-conductor female plug; 4 mm²; 4-pole; 4,00 mm²; blue</p>	<p>www.wago.com/769-104/000-006</p>
	<p>Item no.: 769-104/000-036 1-conductor female plug; 4 mm²; 4-pole; 4,00 mm²; gray, green-yellow</p>	<p>www.wago.com/769-104/000-036</p>
	<p>Item no.: 769-104/000-037 1-conductor female plug; 4 mm²; 4-pole; 4,00 mm²; green-yellow, gray</p>	<p>www.wago.com/769-104/000-037</p>
	<p>Item no.: 769-104/000-038 1-conductor female plug; 4 mm²; 4-pole; 4,00 mm²; gray, blue, green-yellow</p>	<p>www.wago.com/769-104/000-038</p>
	<p>Item no.: 769-104/000-039 1-conductor female plug; 4 mm²; 4-pole; 4,00 mm²; green-yellow, blue, gray</p>	<p>www.wago.com/769-104/000-039</p>
	<p>Item no.: 769-104/022-000 1-conductor female plug; angled; 4 mm²; 4-pole; 4,00 mm²; gray</p>	<p>www.wago.com/769-104/022-000</p>
	<p>Item no.: 769-105 1-conductor female plug; 4 mm²; 5-pole; 4,00 mm²; gray</p>	<p>www.wago.com/769-105</p>
	<p>Item no.: 769-105/000-006 1-conductor female plug; 4 mm²; 5-pole; 4,00 mm²; blue</p>	<p>www.wago.com/769-105/000-006</p>
	<p>Item no.: 769-105/000-036 1-conductor female plug; 4 mm²; 5-pole; 4,00 mm²; gray, green-yellow</p>	<p>www.wago.com/769-105/000-036</p>
	<p>Item no.: 769-105/000-037 1-conductor female plug; 4 mm²; 5-pole; 4,00 mm²; green-yellow, gray</p>	<p>www.wago.com/769-105/000-037</p>
	<p>Item no.: 769-105/000-038 1-conductor female plug; 4 mm²; 5-pole; 4,00 mm²; gray, blue, green-yellow</p>	<p>www.wago.com/769-105/000-038</p>
	<p>Item no.: 769-105/000-039 1-conductor female plug; 4 mm²; 5-pole; 4,00 mm²; green-yellow, blue, gray</p>	<p>www.wago.com/769-105/000-039</p>
	<p>Item no.: 769-105/022-000 1-conductor female plug; angled; 4 mm²; 5-pole; 4,00 mm²; gray</p>	<p>www.wago.com/769-105/022-000</p>
	<p>Item no.: 769-106 1-conductor female plug; 4 mm²; 6-pole; 4,00 mm²; gray</p>	<p>www.wago.com/769-106</p>

Subject to changes. Please also observe the further product documentation!



Item no.: 769-106/000-006
1-conductor female plug; 4 mm²; 6-pole; 4,00 mm²; blue

www.wago.com/769-106/000-006



Item no.: 769-106/000-036
1-conductor female plug; 4 mm²; 6-pole; 4,00 mm²; gray, green-yellow

www.wago.com/769-106/000-036

Item no.: 769-106/000-037
1-conductor female plug; 4 mm²; 6-pole; 4,00 mm²; green-yellow, gray

www.wago.com/769-106/000-037

Item no.: 769-106/000-038
1-conductor female plug; 4 mm²; 6-pole; 4,00 mm²; gray, blue, green-yellow

www.wago.com/769-106/000-038

Item no.: 769-106/000-039
1-conductor female plug; 4 mm²; 6-pole; 4,00 mm²; green-yellow, blue, gray

www.wago.com/769-106/000-039



Item no.: 769-106/022-000
1-conductor female plug; angled; 4 mm²; 6-pole; 4,00 mm²; gray

www.wago.com/769-106/022-000



Item no.: 769-107
1-conductor female plug; 4 mm²; 7-pole; 4,00 mm²; gray

www.wago.com/769-107

Item no.: 769-107/000-006
1-conductor female plug; 4 mm²; 7-pole; 4,00 mm²; blue

www.wago.com/769-107/000-006



Item no.: 769-107/000-036
1-conductor female plug; 4 mm²; 7-pole; 4,00 mm²; gray, green-yellow

www.wago.com/769-107/000-036



Item no.: 769-107/000-037
1-conductor female plug; 4 mm²; 7-pole; 4,00 mm²; green-yellow, gray

www.wago.com/769-107/000-037

Item no.: 769-107/000-038
1-conductor female plug; 4 mm²; 7-pole; 4,00 mm²; gray, blue, green-yellow

www.wago.com/769-107/000-038

Item no.: 769-107/000-039
1-conductor female plug; 4 mm²; 7-pole; 4,00 mm²; green-yellow, blue, gray

www.wago.com/769-107/000-039

Item no.: 769-107/022-000
1-conductor female plug; angled; 4 mm²; 7-pole; 4,00 mm²; gray















www.wago.com/769-107/022-000

















Item no.: 769-108
1-conductor female plug; 4 mm²; 8-pole; 4,00 mm²; gray

www.wago.com/769-108















Subject to changes. Please also observe the further product documentation!

	<p>Item no.: 769-108/000-006 1-conductor female plug; 4 mm²; 8-pole; 4,00 mm²; blue</p>	www.wago.com/769-108/000-006
	<p>Item no.: 769-108/000-036 1-conductor female plug; 4 mm²; 8-pole; 4,00 mm²; gray, green-yellow</p>	www.wago.com/769-108/000-036
	<p>Item no.: 769-108/000-037 1-conductor female plug; 4 mm²; 8-pole; 4,00 mm²; green-yellow, gray</p>	www.wago.com/769-108/000-037
	<p>Item no.: 769-108/000-038 1-conductor female plug; 4 mm²; 8-pole; 4,00 mm²; gray, blue, green-yellow</p>	www.wago.com/769-108/000-038
	<p>Item no.: 769-108/000-039 1-conductor female plug; 4 mm²; 8-pole; 4,00 mm²; green-yellow, blue, gray</p>	www.wago.com/769-108/000-039
	<p>Item no.: 769-108/022-000 1-conductor female plug; angled; 4 mm²; 8-pole; 4,00 mm²; gray</p>	www.wago.com/769-108/022-000
	<p>Item no.: 769-109 1-conductor female plug; 4 mm²; 9-pole; 4,00 mm²; gray</p>	www.wago.com/769-109
	<p>Item no.: 769-109/000-006 1-conductor female plug; 4 mm²; 9-pole; 4,00 mm²; blue</p>	www.wago.com/769-109/000-006
	<p>Item no.: 769-109/000-036 1-conductor female plug; 4 mm²; 9-pole; 4,00 mm²; gray, green-yellow</p>	www.wago.com/769-109/000-036
	<p>Item no.: 769-109/000-037 1-conductor female plug; 4 mm²; 9-pole; 4,00 mm²; green-yellow, gray</p>	www.wago.com/769-109/000-037
	<p>Item no.: 769-109/000-038 1-conductor female plug; 4 mm²; 9-pole; 4,00 mm²; gray, blue, green-yellow</p>	www.wago.com/769-109/000-038
	<p>Item no.: 769-109/000-039 1-conductor female plug; 4 mm²; 9-pole; 4,00 mm²; green-yellow, blue, gray</p>	www.wago.com/769-109/000-039
	<p>Item no.: 769-109/022-000 1-conductor female plug; angled; 4 mm²; 9-pole; 4,00 mm²; gray</p>	www.wago.com/769-109/022-000
	<p>Item no.: 769-110 1-conductor female plug; 4 mm²; 10-pole; 4,00 mm²; gray</p>	www.wago.com/769-110















Subject to changes. Please also observe the further product documentation!

	<p>Item no.: 769-110/000-006 1-conductor female plug; 4 mm²; 10-pole; 4,00 mm²; blue</p>	www.wago.com/769-110/000-006
	<p>Item no.: 769-110/000-036 1-conductor female plug; 4 mm²; 10-pole; 4,00 mm²; gray, green-yellow</p>	www.wago.com/769-110/000-036
	<p>Item no.: 769-110/000-037 1-conductor female plug; 4 mm²; 10-pole; 4,00 mm²; green-yellow, gray</p>	www.wago.com/769-110/000-037
	<p>Item no.: 769-110/000-038 1-conductor female plug; 4 mm²; 10-pole; 4,00 mm²; gray, blue, green-yellow</p>	www.wago.com/769-110/000-038
	<p>Item no.: 769-110/000-039 1-conductor female plug; 4 mm²; 10-pole; 4,00 mm²; green-yellow, blue, gray</p>	www.wago.com/769-110/000-039
	<p>Item no.: 769-110/022-000 1-conductor female plug; angled; 4 mm²; 10-pole; 4,00 mm²; gray</p>	www.wago.com/769-110/022-000
	<p>Item no.: 769-111 1-conductor female plug; 4 mm²; 11-pole; 4,00 mm²; gray</p>	www.wago.com/769-111
	<p>Item no.: 769-111/000-006 1-conductor female plug; 4 mm²; 11-pole; 4,00 mm²; blue</p>	www.wago.com/769-111/000-006
	<p>Item no.: 769-111/000-036 1-conductor female plug; 4 mm²; 11-pole; 4,00 mm²; gray, green-yellow</p>	www.wago.com/769-111/000-036
	<p>Item no.: 769-111/000-037 1-conductor female plug; 4 mm²; 11-pole; 4,00 mm²; green-yellow, gray</p>	www.wago.com/769-111/000-037
	<p>Item no.: 769-111/000-038 1-conductor female plug; 4 mm²; 11-pole; 4,00 mm²; gray, blue, green-yellow</p>	www.wago.com/769-111/000-038
	<p>Item no.: 769-111/000-039 1-conductor female plug; 4 mm²; 11-pole; 4,00 mm²; green-yellow, blue, gray</p>	www.wago.com/769-111/000-039
	<p>Item no.: 769-111/022-000 1-conductor female plug; angled; 4 mm²; 11-pole; 4,00 mm²; gray</p>	www.wago.com/769-111/022-000
	<p>Item no.: 769-112 1-conductor female plug; 4 mm²; 12-pole; 4,00 mm²; gray</p>	www.wago.com/769-112

Subject to changes. Please also observe the further product documentation!

















	Item no.: 769-112/000-006 1-conductor female plug; 4 mm ² ; 12-pole; 4,00 mm ² ; blue	www.wago.com/769-112/000-006
	Item no.: 769-112/000-036 1-conductor female plug; 4 mm ² ; 12-pole; 4,00 mm ² ; gray, green-yellow	www.wago.com/769-112/000-036
	Item no.: 769-112/000-037 1-conductor female plug; 4 mm ² ; 12-pole; 4,00 mm ² ; green-yellow, gray	www.wago.com/769-112/000-037
	Item no.: 769-112/000-038 1-conductor female plug; 4 mm ² ; 12-pole; 4,00 mm ² ; gray, blue, green-yellow	www.wago.com/769-112/000-038
	Item no.: 769-112/000-039 1-conductor female plug; 4 mm ² ; 12-pole; 4,00 mm ² ; green-yellow, blue, gray	www.wago.com/769-112/000-039
	Item no.: 769-112/022-000 1-conductor female plug; angled; 4 mm ² ; 12-pole; 4,00 mm ² ; gray	www.wago.com/769-112/022-000
	Item no.: 769-113 1-conductor female plug; 4 mm ² ; 13-pole; 4,00 mm ² ; gray	www.wago.com/769-113
	Item no.: 769-113/000-036 1-conductor female plug; 4 mm ² ; 13-pole; 4,00 mm ² ; gray, green-yellow	www.wago.com/769-113/000-036
	Item no.: 769-113/000-037 1-conductor female plug; 4 mm ² ; 13-pole; 4,00 mm ² ; green-yellow, gray	www.wago.com/769-113/000-037
	Item no.: 769-113/000-038 1-conductor female plug; 4 mm ² ; 13-pole; 4,00 mm ² ; gray, blue, green-yellow	www.wago.com/769-113/000-038
	Item no.: 769-113/000-039 1-conductor female plug; 4 mm ² ; 13-pole; 4,00 mm ² ; green-yellow, blue, gray	www.wago.com/769-113/000-039
	Item no.: 769-113/022-000 1-conductor female plug; angled; 4 mm ² ; 13-pole; 4,00 mm ² ; gray	www.wago.com/769-113/022-000
	Item no.: 769-114 1-conductor female plug; 4 mm ² ; 14-pole; 4,00 mm ² ; gray	www.wago.com/769-114
	Item no.: 769-114/000-006 1-conductor female plug; 4 mm ² ; 14-pole; 4,00 mm ² ; blue	www.wago.com/769-114/000-006

Subject to changes. Please also observe the further product documentation!















	Item no.: 769-114/000-036 1-conductor female plug; 4 mm ² ; 14-pole; 4,00 mm ² ; gray, green-yellow	www.wago.com/769-114/000-036
	Item no.: 769-114/000-037 1-conductor female plug; 4 mm ² ; 14-pole; 4,00 mm ² ; green-yellow, gray	www.wago.com/769-114/000-037
	Item no.: 769-114/000-038 1-conductor female plug; 4 mm ² ; 14-pole; 4,00 mm ² ; gray, blue, green-yellow	www.wago.com/769-114/000-038
	Item no.: 769-114/000-039 1-conductor female plug; 4 mm ² ; 14-pole; 4,00 mm ² ; green-yellow, blue, gray	www.wago.com/769-114/000-039
	Item no.: 769-114/022-000 1-conductor female plug; angled; 4 mm ² ; 14-pole; 4,00 mm ² ; gray	www.wago.com/769-114/022-000
	Item no.: 769-115 1-conductor female plug; 4 mm ² ; 15-pole; 4,00 mm ² ; gray	www.wago.com/769-115
	Item no.: 769-115/000-036 1-conductor female plug; 4 mm ² ; 15-pole; 4,00 mm ² ; gray, green-yellow	www.wago.com/769-115/000-036
	Item no.: 769-115/000-037 1-conductor female plug; 4 mm ² ; 15-pole; 4,00 mm ² ; green-yellow, gray	www.wago.com/769-115/000-037
	Item no.: 769-115/000-038 1-conductor female plug; 4 mm ² ; 15-pole; 4,00 mm ² ; gray, blue, green-yellow	www.wago.com/769-115/000-038
	Item no.: 769-115/000-039 1-conductor female plug; 4 mm ² ; 15-pole; 4,00 mm ² ; green-yellow, blue, gray	www.wago.com/769-115/000-039
	Item no.: 769-115/022-000 1-conductor female plug; angled; 4 mm ² ; 15-pole; 4,00 mm ² ; gray	www.wago.com/769-115/022-000
	Item no.: 769-121 2-conductor female connector; 4 mm ² ; 1-pole; 4,00 mm ² ; gray	www.wago.com/769-121
	Item no.: 769-121/000-016 2-conductor female connector; 4 mm ² ; 1-pole; 4,00 mm ² ; green-yellow	www.wago.com/769-121/000-016
	Item no.: 769-122 2-conductor female connector; 4 mm ² ; 2-pole; 4,00 mm ² ; gray	www.wago.com/769-122

Item no.: 769-123

Subject to changes. Please also observe the further product documentation!

	2-conductor female connector; 4 mm ² ; 3-pole; 4,00 mm ² ; gray	www.wago.com/769-123
	Item no.: 769-124 2-conductor female connector; 4 mm ² ; 4-pole; 4,00 mm ² ; gray	www.wago.com/769-124
	Item no.: 769-125 2-conductor female connector; 4 mm ² ; 5-pole; 4,00 mm ² ; gray	www.wago.com/769-125
	Item no.: 769-126 2-conductor female connector; 4 mm ² ; 6-pole; 4,00 mm ² ; gray	www.wago.com/769-126
	Item no.: 769-127 2-conductor female connector; 4 mm ² ; 7-pole; 4,00 mm ² ; gray	www.wago.com/769-127
	Item no.: 769-128 2-conductor female connector; 4 mm ² ; 8-pole; 4,00 mm ² ; gray	www.wago.com/769-128
	Item no.: 769-129 2-conductor female connector; 4 mm ² ; 9-pole; 4,00 mm ² ; gray	www.wago.com/769-129
	Item no.: 769-130 2-conductor female connector; 4 mm ² ; 10-pole; 4,00 mm ² ; gray	www.wago.com/769-130
	Item no.: 769-131 2-conductor female connector; 4 mm ² ; 11-pole; 4,00 mm ² ; gray	www.wago.com/769-131
	Item no.: 769-132 2-conductor female connector; 4 mm ² ; 12-pole; 4,00 mm ² ; gray	www.wago.com/769-132
	Item no.: 769-133 2-conductor female connector; 4 mm ² ; 13-pole; 4,00 mm ² ; gray	www.wago.com/769-133
	Item no.: 769-134 2-conductor female connector; 4 mm ² ; 14-pole; 4,00 mm ² ; gray	www.wago.com/769-134
	Item no.: 769-135 2-conductor female connector; 4 mm ² ; 15-pole; 4,00 mm ² ; gray	www.wago.com/769-135
assembling		
	Item no.: 209-106 Mounting carrier; for isolated mounting on DIN 35 rails; gray	www.wago.com/209-106
General accessories		
	Item no.: 769-438 Pin cover; with marker slot for miniature WSB; gray	www.wago.com/769-438
	Item no.: 769-439 Pin cover; with marker slot for miniature WSB; orange	www.wago.com/769-439
	Item no.: 769-501 Start module for 1-conductor female connector; with integrated end plate; 4 mm ² ; 1-pole; 4,00 mm ² ; gray	www.wago.com/769-501

Subject to changes. Please also observe the further product documentation!

	<p>Item no.: 769-501/000-006 Start module for 1-conductor female connector; 4 mm²; 1-pole; 4,00 mm²; blue</p>	www.wago.com/769-501/000-006
	<p>Item no.: 769-501/000-016 Start module for 1-conductor female connector; with integrated end plate; 4 mm²; 1-pole; 4,00 mm²; green-yellow</p>	www.wago.com/769-501/000-016
	<p>Item no.: 769-502 Center module for 1-conductor female connector; 4 mm²; 1-pole; 4,00 mm²; gray</p>	www.wago.com/769-502
	<p>Item no.: 769-502/000-006 Center module for 1-conductor female connector; 4 mm²; 1-pole; 4,00 mm²; blue</p>	www.wago.com/769-502/000-006
	<p>Item no.: 769-502/000-016 Center module for 1-conductor female connector; 4 mm²; 1-pole; 4,00 mm²; green-yellow</p>	www.wago.com/769-502/000-016
	<p>Item no.: 769-503 End module for 1-conductor female connector; 4 mm²; 1-pole; 4,00 mm²; gray</p>	www.wago.com/769-503
	<p>Item no.: 769-503/000-006 End module for 1-conductor female connector; 4 mm²; 1-pole; 4,00 mm²; blue</p>	www.wago.com/769-503/000-006
	<p>Item no.: 769-503/000-016 End module for 1-conductor female connector; 4 mm²; 1-pole; 4,00 mm²; green-yellow</p>	www.wago.com/769-503/000-016
	<p>Item no.: 769-504 Start module for 2-conductor female connector; with integrated end plate; 4 mm²; 1-pole; 4,00 mm²; gray</p>	www.wago.com/769-504
	<p>Item no.: 769-504/000-006 Start module for 2-conductor female connector; with integrated end plate; 4 mm²; 1-pole; 4,00 mm²; blue</p>	www.wago.com/769-504/000-006
	<p>Item no.: 769-504/000-016 Start module for 2-conductor female connector; 4 mm²; 1-pole; 4,00 mm²; green-yellow</p>	www.wago.com/769-504/000-016
	<p>Item no.: 769-505 Center module for 2-conductor female connector; 4 mm²; 1-pole; 4,00 mm²; gray</p>	www.wago.com/769-505
	<p>Item no.: 769-505/000-006 Center module for 2-conductor female connector; 4 mm²; 1-pole; 4,00 mm²; blue</p>	www.wago.com/769-505/000-006
	<p>Item no.: 769-505/000-016 Center module for 2-conductor female connector; 4 mm²; 1-pole; 4,00 mm²; green-yellow</p>	www.wago.com/769-505/000-016
	<p>Item no.: 769-506 End module for 2-conductor female connector; 4 mm²; 1-pole; 4,00 mm²; gray</p>	www.wago.com/769-506

Subject to changes. Please also observe the further product documentation!



Item no.: 769-506/000-006
End module for 2-conductor female connector; 4 mm²; 1-pole; 4,00 mm²; blue

www.wago.com/769-506/000-006



Item no.: 769-506/000-016
End module for 2-conductor female connector; 4 mm²; 1-pole; 4,00 mm²; green-yellow

www.wago.com/769-506/000-016



Item no.: 769-512
Start module for 1-conductor female connector; angled; 4 mm²; 1-pole; 4,00 mm²; gray

www.wago.com/769-512



Item no.: 769-512/000-006
Start module for 1-conductor female connector; angled; 4 mm²; 1-pole; 4,00 mm²; blue

www.wago.com/769-512/000-006



Item no.: 769-512/000-016
Start module for 1-conductor female connector; angled; 4 mm²; 1-pole; 4,00 mm²; green-yellow

www.wago.com/769-512/000-016



Item no.: 769-513
Center module for 1-conductor female connector; angled; 4 mm²; 1-pole; 4,00 mm²; gray

www.wago.com/769-513



Item no.: 769-513/000-006
Center module for 1-conductor female connector; angled; 4 mm²; 1-pole; 4,00 mm²; blue

www.wago.com/769-513/000-006



Item no.: 769-513/000-016
Center module for 1-conductor female connector; angled; 4 mm²; 1-pole; 4,00 mm²; green-yellow

www.wago.com/769-513/000-016



Item no.: 769-515
End module for 1-conductor female connector; angled; 4 mm²; 1-pole; 4,00 mm²; gray

www.wago.com/769-515



Item no.: 769-515/000-006
End module for 1-conductor female connector; angled; 4 mm²; 1-pole; 4,00 mm²; blue

www.wago.com/769-515/000-006



Item no.: 769-515/000-016
End module for 1-conductor female connector; angled; 4 mm²; 1-pole; 4,00 mm²; green-yellow

www.wago.com/769-515/000-016

End plate



Item no.: 769-309
End and intermediate plate; 1.1 mm thick; gray

www.wago.com/769-309



Item no.: 769-310
End and intermediate plate; 1.1 mm thick; orange

www.wago.com/769-310









Item no.: 769-313
Separator plate; 1.1 mm thick; oversized; orange



www.wago.com/769-313

Subject to changes. Please also observe the further product documentation!

Jumper









	Item no.: 249-123 Push-in type wire jumper; insulated; wire length 180 mm; Conductor cross section 0.75 mm ²	www.wago.com/249-123
	Item no.: 249-125 Push-in type wire jumper; insulated; wire length 60 mm; Conductor cross section 0.75 mm ²	www.wago.com/249-125
	Item no.: 249-126 Push-in type wire jumper; insulated; wire length 110 mm; Conductor cross section 0.75 mm ²	www.wago.com/249-126
	Item no.: 249-127 Push-in type wire jumper; insulated; wire length 250 mm; Conductor cross section 0.75 mm ²	www.wago.com/249-127
	Item no.: 280-402 Adjacent jumper; insulated; IN = IN terminal block; gray	www.wago.com/280-402
	Item no.: 280-409 Alternate jumper; insulated; IN = IN terminal block; gray	www.wago.com/280-409
	Item no.: 780-452 Staggered jumper; insulated; from 1 to 2; Spacing: 5 mm; suitable for 2-conductor female plugs; gray	www.wago.com/780-452
	Item no.: 780-453 Staggered jumper; insulated; from 1 to 3; Spacing: 5 mm; suitable for 2-conductor female plugs; gray	www.wago.com/780-453
	Item no.: 780-454 Staggered jumper; insulated; from 1 to 4; Spacing: 5 mm; suitable for 2-conductor female plugs; gray	www.wago.com/780-454
	Item no.: 780-455 Staggered jumper; insulated; from 1 to 5; Spacing: 5 mm; suitable for 2-conductor female plugs; gray	www.wago.com/780-455
	Item no.: 780-456 Staggered jumper; insulated; from 1 to 6; Spacing: 5 mm; suitable for 2-conductor female plugs; gray	www.wago.com/780-456
	Item no.: 780-457 Staggered jumper; insulated; from 1 to 7; Spacing: 5 mm; suitable for 2-conductor female plugs; gray	www.wago.com/780-457
	Item no.: 780-458 Staggered jumper; insulated; from 1 to 8; Spacing: 5 mm; suitable for 2-conductor female plugs; gray	www.wago.com/780-458

Test Accessories

	Item no.: 210-137 Test plug; 2.3 mm Ø; with 500 mm cable; yellow	www.wago.com/210-137
	Item no.: 280-404 Test plug adapter; 5 mm wide; for test plug 210-137 (2.3 mm Ø); suitable for 1.5 mm ² - 4 mm ² tbs; gray	www.wago.com/280-404
	Item no.: 280-418 Test plug module; modular; suitable for all WAGO 280 and 780 Series rail-mounted terminal blocks with jumper slots in the current bar; gray	www.wago.com/280-418
	Item no.: 280-419 Spacer module; modular; bridging commoned terminal blocks; gray	www.wago.com/280-419

Subject to changes. Please also observe the further product documentation!

Marking accessories

	Item no.: 2009-145 Mini-WSB Inline; for Smart Printer; 1700 pieces on roll; stretchable 5 - 5.2 mm; plain; snap-on type; white	www.wago.com/2009-145
	Item no.: 2009-145/000-002 Mini-WSB Inline; for Smart Printer; 1700 pieces on roll; stretchable 5 - 5.2 mm; plain; snap-on type; white	www.wago.com/2009-145/000-002
	Item no.: 2009-145/000-005 Mini-WSB Inline; for Smart Printer; 1700 pieces on roll; stretchable 5 - 5.2 mm; plain; snap-on type; red	www.wago.com/2009-145/000-005
	Item no.: 2009-145/000-006 Mini-WSB Inline; for Smart Printer; 1700 pieces on roll; stretchable 5 - 5.2 mm; plain; snap-on type; blue	www.wago.com/2009-145/000-006
	Item no.: 2009-145/000-007 Mini-WSB Inline; for Smart Printer; 1700 pieces on roll; stretchable 5 - 5.2 mm; plain; snap-on type; white	www.wago.com/2009-145/000-007
	Item no.: 2009-145/000-012 Mini-WSB Inline; for Smart Printer; 1700 pieces on roll; stretchable 5 - 5.2 mm; plain; snap-on type; orange	www.wago.com/2009-145/000-012
	Item no.: 2009-145/000-023 Mini-WSB Inline; for Smart Printer; 1700 pieces on roll; stretchable 5 - 5.2 mm; plain; snap-on type; green	www.wago.com/2009-145/000-023
	Item no.: 2009-145/000-024 Mini-WSB Inline; for Smart Printer; 1700 pieces on roll; stretchable 5 - 5.2 mm; plain; snap-on type; violet	www.wago.com/2009-145/000-024
	Item no.: 248-501 Miniature WSB Quick marking system; plain; Marker width 5 mm; 10 strips with 10 markers per card	www.wago.com/248-501
	Item no.: 248-501/000-002 Mini-WSB marking card; as card; not stretchable; plain; snap-on type; yellow	www.wago.com/248-501/000-002
	Item no.: 248-501/000-005 Mini-WSB marking card; as card; not stretchable; plain; snap-on type; red	www.wago.com/248-501/000-005
	Item no.: 248-501/000-006 Mini-WSB marking card; as card; not stretchable; plain; snap-on type; blue	www.wago.com/248-501/000-006
	Item no.: 248-501/000-007 Mini-WSB marking card; as card; not stretchable; plain; snap-on type; gray	www.wago.com/248-501/000-007

Subject to changes. Please also observe the further product documentation!



Item no.: 248-501/000-012

Mini-WSB marking card; as card; not stretchable; plain; snap-on type; orange

www.wago.com/248-501/000-012

Item no.: 248-501/000-017

Mini-WSB marking card; as card; not stretchable; plain; snap-on type; light green

www.wago.com/248-501/000-017



Item no.: 248-501/000-023

Mini-WSB marking card; as card; not stretchable; plain; snap-on type; green

www.wago.com/248-501/000-023

Item no.: 248-501/000-024

Mini-WSB marking card; as card; not stretchable; plain; snap-on type; violet

www.wago.com/248-501/000-024

tools



Item no.: 210-720

Operating tool; Blade: 3.5 x 0.5 mm; with a partially insulated shaft

www.wago.com/210-720

Downloads

Documentation

Additional Information

Technical explanations

Apr 3, 2019

pdf
2.1 MB

[Download](#)

CAD/CAE-Data

CAD data

2D/3D Models 769-208/281-411

[URL](#)

[Download](#)

CAE data

EPLAN Data Portal 769-208/281-411

[URL](#)

[Download](#)

WSCAD Universe 769-208/281-411

[URL](#)

[Download](#)

Installation Notes

Assembly

Subject to changes. Please also observe the further product documentation!

WAGO Kontakttechnik GmbH & Co. KG

Hansastr. 27

32423 Minden

Phone: +49571 887-0 | Fax: +49571 887-169

Email: info.de@wago.com | Web: www.wago.com

Do you have any questions about our products?

We are always happy to take your call at +49 (571) 887-44222.

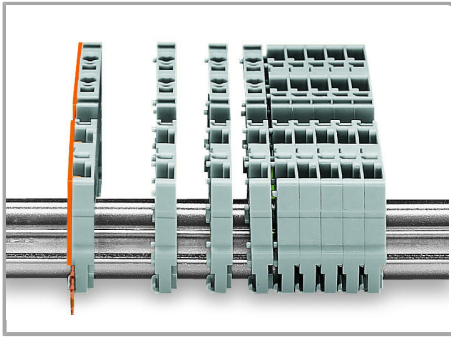

Snap individual carrier terminal blocks onto the carrier rail and slide together.

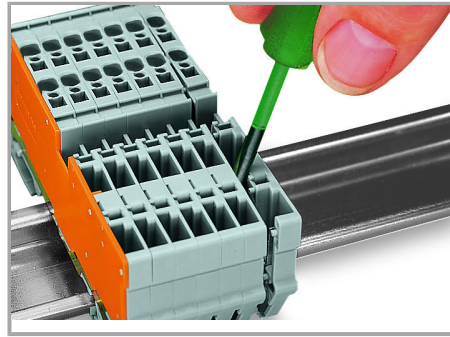

Open the assembly by laterally sliding a block via operating tool and remove terminal block via release lever.

Jumpered

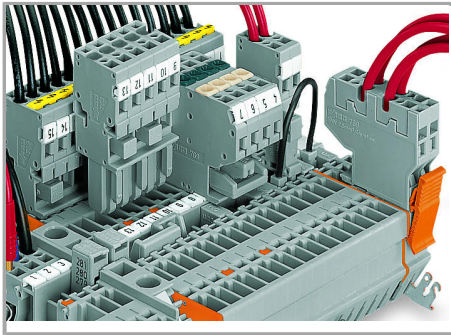

Commoning with adjacent or staggered jumpers –

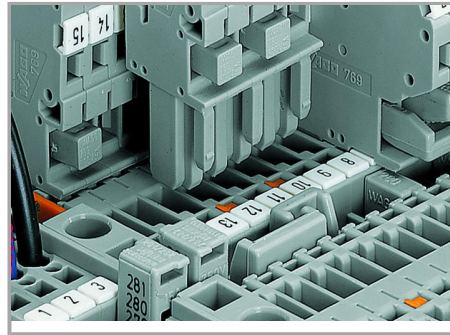

Commoning carrier terminal blocks via staggered jumpers.

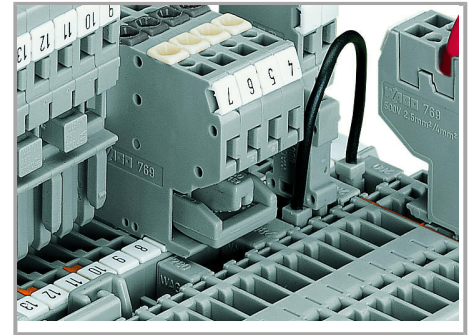

Commoning a 2-conductor female plug via staggered jumper and carrier terminal blocks via adjacent jumpers.

push jumpers down until fully inserted.

Subject to changes. Please also observe the further product documentation!

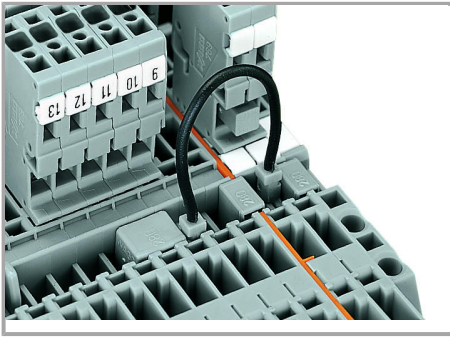

Commoning carrier terminal blocks via push-in type wire jumpers or adjacent jumpers – even over an intermediate plate.

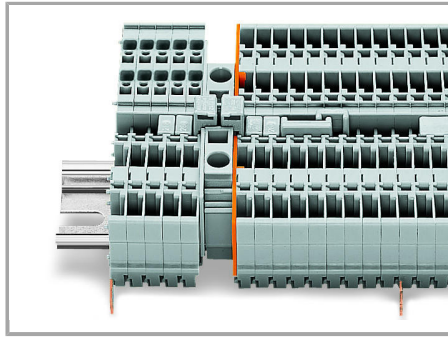

Commoning “supply terminal blocks” (up to 10 mm²/8 AWG) with carrier terminal blocks via step-down jumpers.

Testing

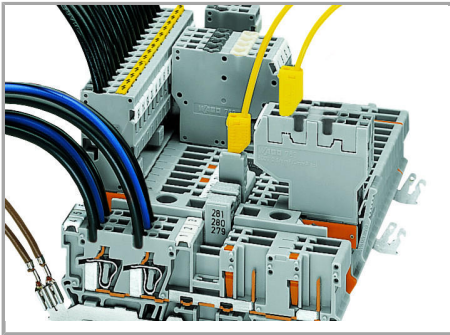

Testing via 2 or 2.3 mm Ø test plugs.

Coding

Subject to changes. Please also observe the further product documentation!

WAGO Kontakttechnik GmbH & Co. KG
Hansastr. 27
32423 Minden
Phone: +49571 887-0 | Fax: +49571 887-169
Email: info.de@wago.com | Web: www.wago.com

Do you have any questions about our products?
We are always happy to take your call at +49 (571) 887-44222.

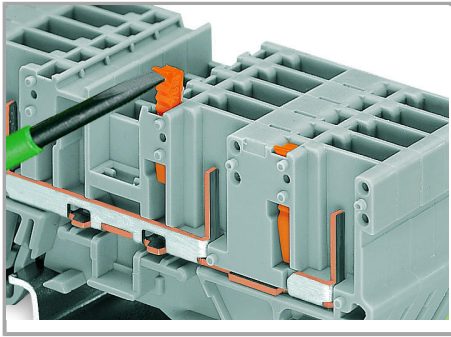

Snap coding pin in proper direction on carrier terminal block.

Shown: Coding pin removal from carrier terminal block.

Locking

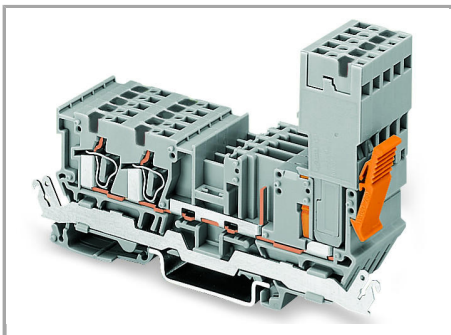

Female plug secured with locking lever on the terminal block side.

Product family

X-COM

[Learn more about the product family.](#)

[Show all products from the family](#)

Subject to changes. Please also observe the further product documentation!