

Data sheet | Item number: 769-202

2-pin disconnect carrier terminal block; with 2 jumper positions; for DIN-rail
35 x 15 and 35 x 7.5; gray

www.wago.com/769-202

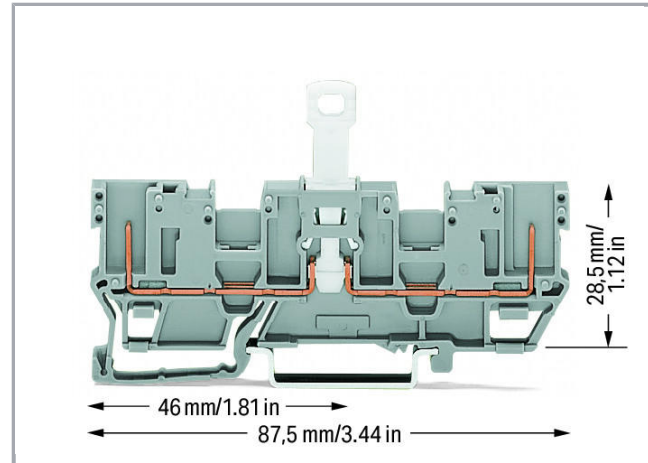
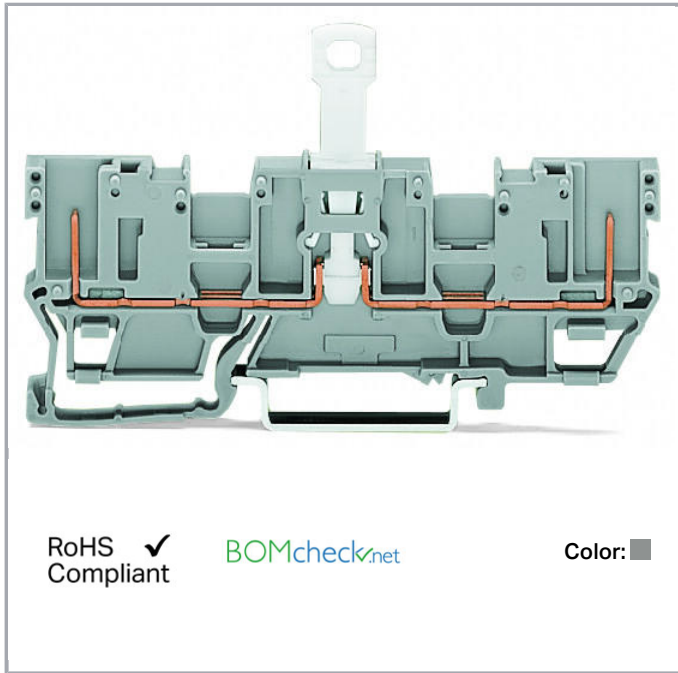

Data

Electrical data

Ratings per IEC/EN 60664-1

Rated voltage (III / 3)	400 V
Rated impulse voltage (III / 3)	6 kV
Rated current	16 A
Legend (ratings)	(III / 3) ≙ Overvoltage category III / Pollution degree 3

Connection data

Total number of potentials	1
Number of levels	1
Type of wiring	Front-entry wiring

Geometrical Data

Width	5 mm / 0.197 inch
-------	-------------------

Subject to changes. Please also observe the further product documentation!

WAGO Kontakttechnik GmbH & Co. KG
Hansastr. 27
32423 Minden
Phone: +49571 887-0 | Fax: +49571 887-169
Email: info.de@wago.com | Web: www.wago.com

Do you have any questions about our products?
We are always happy to take your call at +49 (571) 887-44222.

Height from upper-edge of DIN-35 rail	28.5 mm / 1.122 inch
Depth	87.5 mm / 3.445 inch

Mechanical data

Design	horizontal
Type of mounting	DIN-35 rail
Marking level	Center marking

Material Data



Color	gray
Insulating material	Polyamide 66 (PA 66)
Fire load	0.179 MJ
Weight	8.2 g

Commercial data

Product Group	18 (X-COM-System)
Packaging type	BOX
Country of origin	DE
GTIN	4044918630108
Customs Tariff No.	85365080900



Approvals / Certificates

Country specific Approvals



Logo	Approval	Additional Approval Text	Certificate name
	CCA DEKRA Certification B.V.	EN 60947	NTR NL-7626
	CSA DEKRA Certification B.V.	C22.2 No. 158	1101144
	KEMA/KEUR DEKRA Certification B.V.	EN 60947	2190419.01

Ship Approvals

Subject to changes. Please also observe the further product documentation!

Logo	Approval	Additional Approval Text	Certificate name
	ABS American Bureau of Shipping	EN 60947	20- HG1941090- PDA
	DNV GL Det Norske Veritas, Germanischer Lloyd	-	TAE00001V2
	LR Lloyds Register	EN 60947	91/20112 (E9)

UL-Approvals

Logo	Approval	Additional Approval Text	Certificate name
	UR Underwriters Laboratories Inc.	UL 1059	20190731- E45172
	UR Underwriters Laboratories Inc.	UL 1977	20151210- E45171

Counterpart

Compatible products

Marking accessories

Item no.: 2009-145









Mini-WSB Inline; for Smart Printer; 1700 pieces on roll; stretchable 5 - 5.2 mm; plain; snap-on type; www.wago.com/2009-145

Subject to changes. Please also observe the further product documentation!

WAGO Kontakttechnik GmbH & Co. KG
 Hansastr. 27
 32423 Minden
 Phone: +49571 887-0 | Fax: +49571 887-169
 Email: info.de@wago.com | Web: www.wago.com

Do you have any questions about our products?
 We are always happy to take your call at +49 (571) 887-44222.

white

	Item no.: 2009-145/000-002 Mini-WSB Inline; for Smart Printer; 1700 pieces on roll; stretchable 5 - 5.2 mm; plain; snap-on type; white	www.wago.com/2009-145/000-002
	Item no.: 2009-145/000-005 Mini-WSB Inline; for Smart Printer; 1700 pieces on roll; stretchable 5 - 5.2 mm; plain; snap-on type; red	www.wago.com/2009-145/000-005
	Item no.: 2009-145/000-006 Mini-WSB Inline; for Smart Printer; 1700 pieces on roll; stretchable 5 - 5.2 mm; plain; snap-on type; blue	www.wago.com/2009-145/000-006
	Item no.: 2009-145/000-007 Mini-WSB Inline; for Smart Printer; 1700 pieces on roll; stretchable 5 - 5.2 mm; plain; snap-on type; white	www.wago.com/2009-145/000-007
	Item no.: 2009-145/000-012 Mini-WSB Inline; for Smart Printer; 1700 pieces on roll; stretchable 5 - 5.2 mm; plain; snap-on type; orange	www.wago.com/2009-145/000-012
	Item no.: 2009-145/000-023 Mini-WSB Inline; for Smart Printer; 1700 pieces on roll; stretchable 5 - 5.2 mm; plain; snap-on type; green	www.wago.com/2009-145/000-023
	Item no.: 2009-145/000-024 Mini-WSB Inline; for Smart Printer; 1700 pieces on roll; stretchable 5 - 5.2 mm; plain; snap-on type; violet	www.wago.com/2009-145/000-024
	Item no.: 248-501 Miniature WSB Quick marking system; plain; Marker width 5 mm; 10 strips with 10 markers per card	www.wago.com/248-501
	Item no.: 248-501/000-002 Mini-WSB marking card; as card; not stretchable; plain; snap-on type; yellow	www.wago.com/248-501/000-002
	Item no.: 248-501/000-005 Mini-WSB marking card; as card; not stretchable; plain; snap-on type; red	www.wago.com/248-501/000-005
	Item no.: 248-501/000-006 Mini-WSB marking card; as card; not stretchable; plain; snap-on type; blue	www.wago.com/248-501/000-006
	Item no.: 248-501/000-007 Mini-WSB marking card; as card; not stretchable; plain; snap-on type; gray	www.wago.com/248-501/000-007
	Item no.: 248-501/000-012 Mini-WSB marking card; as card; not stretchable; plain; snap-on type; orange	www.wago.com/248-501/000-012

Subject to changes. Please also observe the further product documentation!

Item no.: 248-501/000-017

Mini-WSB marking card; as card; not stretchable; plain; snap-on type; light green

www.wago.com/248-501/000-017

Item no.: 248-501/000-023

Mini-WSB marking card; as card; not stretchable; plain; snap-on type; green

www.wago.com/248-501/000-023

Item no.: 248-501/000-024

Mini-WSB marking card; as card; not stretchable; plain; snap-on type; violet

www.wago.com/248-501/000-024

End plate



Item no.: 769-309

End and intermediate plate; 1.1 mm thick; gray

www.wago.com/769-309

Item no.: 769-310

End and intermediate plate; 1.1 mm thick; orange

www.wago.com/769-310

Item no.: 769-313

Separator plate; 1.1 mm thick; oversized; orange

www.wago.com/769-313

Female plug



Item no.: 769-101

1-conductor female plug; 4 mm²; 1-pole; 4,00 mm²; graywww.wago.com/769-101

Item no.: 769-101/000-006

1-conductor female plug; 4 mm²; 1-pole; 4,00 mm²; bluewww.wago.com/769-101/000-006

Item no.: 769-101/000-016

1-conductor female plug; 4 mm²; 1-pole; 4,00 mm²; green-yellowwww.wago.com/769-101/000-016

Item no.: 769-101/022-000

1-conductor female plug; angled; 4 mm²; 1-pole; 4,00 mm²; graywww.wago.com/769-101/022-000

Item no.: 769-101/022-016

1-conductor female plug; angled; 4 mm²; 1-pole; 4,00 mm²; green-yellowwww.wago.com/769-101/022-016

Item no.: 769-102

1-conductor female plug; 4 mm²; 2-pole; 4,00 mm²; graywww.wago.com/769-102

Item no.: 769-102/000-006

1-conductor female plug; 4 mm²; 2-pole; 4,00 mm²; bluewww.wago.com/769-102/000-006

Item no.: 769-102/000-036

1-conductor female plug; 4 mm²; 2-pole; 4,00 mm²; gray, green-yellowwww.wago.com/769-102/000-036

Subject to changes. Please also observe the further product documentation!

WAGO Kontakttechnik GmbH & Co. KG

Hansastr. 27











32423 Minden

Phone: +49571 887-0 | Fax: +49571 887-169









Email: info.de@wago.com | Web: www.wago.com

Do you have any questions about our products?









We are always happy to take your call at +49 (571) 887-44222.

	<p>Item no.: 769-102/000-037 1-conductor female plug; 4 mm²; 2-pole; 4,00 mm²; green-yellow, gray</p>	www.wago.com/769-102/000-037
	<p>Item no.: 769-102/022-000 1-conductor female plug; angled; 4 mm²; 2-pole; 4,00 mm²; gray</p>	www.wago.com/769-102/022-000
	<p>Item no.: 769-103 1-conductor female plug; 4 mm²; 3-pole; 4,00 mm²; gray</p>	www.wago.com/769-103
	<p>Item no.: 769-103/000-006 1-conductor female plug; 4 mm²; 3-pole; 4,00 mm²; blue</p>	www.wago.com/769-103/000-006
	<p>Item no.: 769-103/000-036 1-conductor female plug; 4 mm²; 3-pole; 4,00 mm²; gray, green-yellow</p>	www.wago.com/769-103/000-036
	<p>Item no.: 769-103/000-037 1-conductor female plug; 4 mm²; 3-pole; 4,00 mm²; green-yellow, gray</p>	www.wago.com/769-103/000-037
	<p>Item no.: 769-103/000-038 1-conductor female plug; 4 mm²; 3-pole; 4,00 mm²; gray, blue, green-yellow</p>	www.wago.com/769-103/000-038
	<p>Item no.: 769-103/000-039 1-conductor female plug; 4 mm²; 3-pole; 4,00 mm²; green-yellow, blue, gray</p>	www.wago.com/769-103/000-039
	<p>Item no.: 769-103/022-000 1-conductor female plug; angled; 4 mm²; 3-pole; 4,00 mm²; gray</p>	www.wago.com/769-103/022-000
	<p>Item no.: 769-104 1-conductor female plug; 4 mm²; 4-pole; 4,00 mm²; gray</p>	www.wago.com/769-104
	<p>Item no.: 769-104/000-006 1-conductor female plug; 4 mm²; 4-pole; 4,00 mm²; blue</p>	www.wago.com/769-104/000-006
	<p>Item no.: 769-104/000-036 1-conductor female plug; 4 mm²; 4-pole; 4,00 mm²; gray, green-yellow</p>	www.wago.com/769-104/000-036
	<p>Item no.: 769-104/000-037 1-conductor female plug; 4 mm²; 4-pole; 4,00 mm²; green-yellow, gray</p>	www.wago.com/769-104/000-037
	<p>Item no.: 769-104/000-038 1-conductor female plug; 4 mm²; 4-pole; 4,00 mm²; gray, blue, green-yellow</p>	www.wago.com/769-104/000-038















Subject to changes. Please also observe the further product documentation!

	<p>Item no.: 769-104/000-039 1-conductor female plug; 4 mm²; 4-pole; 4,00 mm²; green-yellow, blue, gray</p>	<p>www.wago.com/769-104/000-039</p>
	<p>Item no.: 769-104/022-000 1-conductor female plug; angled; 4 mm²; 4-pole; 4,00 mm²; gray</p>	<p>www.wago.com/769-104/022-000</p>
	<p>Item no.: 769-105 1-conductor female plug; 4 mm²; 5-pole; 4,00 mm²; gray</p>	<p>www.wago.com/769-105</p>
	<p>Item no.: 769-105/000-006 1-conductor female plug; 4 mm²; 5-pole; 4,00 mm²; blue</p>	<p>www.wago.com/769-105/000-006</p>
	<p>Item no.: 769-105/000-036 1-conductor female plug; 4 mm²; 5-pole; 4,00 mm²; gray, green-yellow</p>	<p>www.wago.com/769-105/000-036</p>
	<p>Item no.: 769-105/000-037 1-conductor female plug; 4 mm²; 5-pole; 4,00 mm²; green-yellow, gray</p>	<p>www.wago.com/769-105/000-037</p>
	<p>Item no.: 769-105/000-038 1-conductor female plug; 4 mm²; 5-pole; 4,00 mm²; gray, blue, green-yellow</p>	<p>www.wago.com/769-105/000-038</p>
	<p>Item no.: 769-105/000-039 1-conductor female plug; 4 mm²; 5-pole; 4,00 mm²; green-yellow, blue, gray</p>	<p>www.wago.com/769-105/000-039</p>
	<p>Item no.: 769-105/022-000 1-conductor female plug; angled; 4 mm²; 5-pole; 4,00 mm²; gray</p>	<p>www.wago.com/769-105/022-000</p>
	<p>Item no.: 769-106 1-conductor female plug; 4 mm²; 6-pole; 4,00 mm²; gray</p>	<p>www.wago.com/769-106</p>
	<p>Item no.: 769-106/000-006 1-conductor female plug; 4 mm²; 6-pole; 4,00 mm²; blue</p>	<p>www.wago.com/769-106/000-006</p>
	<p>Item no.: 769-106/000-036 1-conductor female plug; 4 mm²; 6-pole; 4,00 mm²; gray, green-yellow</p>	<p>www.wago.com/769-106/000-036</p>
	<p>Item no.: 769-106/000-037 1-conductor female plug; 4 mm²; 6-pole; 4,00 mm²; green-yellow, gray</p>	<p>www.wago.com/769-106/000-037</p>
	<p>Item no.: 769-106/000-038 1-conductor female plug; 4 mm²; 6-pole; 4,00 mm²; gray, blue, green-yellow</p>	<p>www.wago.com/769-106/000-038</p>















Subject to changes. Please also observe the further product documentation!

	<p>Item no.: 769-106/000-039 1-conductor female plug; 4 mm²; 6-pole; 4,00 mm²; green-yellow, blue, gray</p>	<p>www.wago.com/769-106/000-039</p>
	<p>Item no.: 769-106/022-000 1-conductor female plug; angled; 4 mm²; 6-pole; 4,00 mm²; gray</p>	<p>www.wago.com/769-106/022-000</p>
	<p>Item no.: 769-107 1-conductor female plug; 4 mm²; 7-pole; 4,00 mm²; gray</p>	<p>www.wago.com/769-107</p>
	<p>Item no.: 769-107/000-006 1-conductor female plug; 4 mm²; 7-pole; 4,00 mm²; blue</p>	<p>www.wago.com/769-107/000-006</p>
	<p>Item no.: 769-107/000-036 1-conductor female plug; 4 mm²; 7-pole; 4,00 mm²; gray, green-yellow</p>	<p>www.wago.com/769-107/000-036</p>
	<p>Item no.: 769-107/000-037 1-conductor female plug; 4 mm²; 7-pole; 4,00 mm²; green-yellow, gray</p>	<p>www.wago.com/769-107/000-037</p>
	<p>Item no.: 769-107/000-038 1-conductor female plug; 4 mm²; 7-pole; 4,00 mm²; gray, blue, green-yellow</p>	<p>www.wago.com/769-107/000-038</p>
	<p>Item no.: 769-107/000-039 1-conductor female plug; 4 mm²; 7-pole; 4,00 mm²; green-yellow, blue, gray</p>	<p>www.wago.com/769-107/000-039</p>
	<p>Item no.: 769-107/022-000 1-conductor female plug; angled; 4 mm²; 7-pole; 4,00 mm²; gray</p>	<p>www.wago.com/769-107/022-000</p>
	<p>Item no.: 769-108 1-conductor female plug; 4 mm²; 8-pole; 4,00 mm²; gray</p>	<p>www.wago.com/769-108</p>
	<p>Item no.: 769-108/000-006 1-conductor female plug; 4 mm²; 8-pole; 4,00 mm²; blue</p>	<p>www.wago.com/769-108/000-006</p>
	<p>Item no.: 769-108/000-036 1-conductor female plug; 4 mm²; 8-pole; 4,00 mm²; gray, green-yellow</p>	<p>www.wago.com/769-108/000-036</p>
	<p>Item no.: 769-108/000-037 1-conductor female plug; 4 mm²; 8-pole; 4,00 mm²; green-yellow, gray</p>	<p>www.wago.com/769-108/000-037</p>
	<p>Item no.: 769-108/000-038 1-conductor female plug; 4 mm²; 8-pole; 4,00 mm²; gray, blue, green-yellow</p>	<p>www.wago.com/769-108/000-038</p>















Subject to changes. Please also observe the further product documentation!

	<p>Item no.: 769-108/000-039 1-conductor female plug; 4 mm²; 8-pole; 4,00 mm²; green-yellow, blue, gray</p>	www.wago.com/769-108/000-039
	<p>Item no.: 769-108/022-000 1-conductor female plug; angled; 4 mm²; 8-pole; 4,00 mm²; gray</p>	www.wago.com/769-108/022-000
	<p>Item no.: 769-109 1-conductor female plug; 4 mm²; 9-pole; 4,00 mm²; gray</p>	www.wago.com/769-109
	<p>Item no.: 769-109/000-006 1-conductor female plug; 4 mm²; 9-pole; 4,00 mm²; blue</p>	www.wago.com/769-109/000-006
	<p>Item no.: 769-109/000-036 1-conductor female plug; 4 mm²; 9-pole; 4,00 mm²; gray, green-yellow</p>	www.wago.com/769-109/000-036
	<p>Item no.: 769-109/000-037 1-conductor female plug; 4 mm²; 9-pole; 4,00 mm²; green-yellow, gray</p>	www.wago.com/769-109/000-037
	<p>Item no.: 769-109/000-038 1-conductor female plug; 4 mm²; 9-pole; 4,00 mm²; gray, blue, green-yellow</p>	www.wago.com/769-109/000-038
	<p>Item no.: 769-109/000-039 1-conductor female plug; 4 mm²; 9-pole; 4,00 mm²; green-yellow, blue, gray</p>	www.wago.com/769-109/000-039
	<p>Item no.: 769-109/022-000 1-conductor female plug; angled; 4 mm²; 9-pole; 4,00 mm²; gray</p>	www.wago.com/769-109/022-000
	<p>Item no.: 769-110 1-conductor female plug; 4 mm²; 10-pole; 4,00 mm²; gray</p>	www.wago.com/769-110
	<p>Item no.: 769-110/000-006 1-conductor female plug; 4 mm²; 10-pole; 4,00 mm²; blue</p>	www.wago.com/769-110/000-006
	<p>Item no.: 769-110/000-036 1-conductor female plug; 4 mm²; 10-pole; 4,00 mm²; gray, green-yellow</p>	www.wago.com/769-110/000-036
	<p>Item no.: 769-110/000-037 1-conductor female plug; 4 mm²; 10-pole; 4,00 mm²; green-yellow, gray</p>	www.wago.com/769-110/000-037
	<p>Item no.: 769-110/000-038 1-conductor female plug; 4 mm²; 10-pole; 4,00 mm²; gray, blue, green-yellow</p>	www.wago.com/769-110/000-038

















Subject to changes. Please also observe the further product documentation!

	<p>Item no.: 769-110/000-039 1-conductor female plug; 4 mm²; 10-pole; 4,00 mm²; green-yellow, blue, gray</p>	www.wago.com/769-110/000-039
	<p>Item no.: 769-110/022-000 1-conductor female plug; angled; 4 mm²; 10-pole; 4,00 mm²; gray</p>	www.wago.com/769-110/022-000
	<p>Item no.: 769-111 1-conductor female plug; 4 mm²; 11-pole; 4,00 mm²; gray</p>	www.wago.com/769-111
	<p>Item no.: 769-111/000-006 1-conductor female plug; 4 mm²; 11-pole; 4,00 mm²; blue</p>	www.wago.com/769-111/000-006
	<p>Item no.: 769-111/000-036 1-conductor female plug; 4 mm²; 11-pole; 4,00 mm²; gray, green-yellow</p>	www.wago.com/769-111/000-036
	<p>Item no.: 769-111/000-037 1-conductor female plug; 4 mm²; 11-pole; 4,00 mm²; green-yellow, gray</p>	www.wago.com/769-111/000-037
	<p>Item no.: 769-111/000-038 1-conductor female plug; 4 mm²; 11-pole; 4,00 mm²; gray, blue, green-yellow</p>	www.wago.com/769-111/000-038
	<p>Item no.: 769-111/000-039 1-conductor female plug; 4 mm²; 11-pole; 4,00 mm²; green-yellow, blue, gray</p>	www.wago.com/769-111/000-039
	<p>Item no.: 769-111/022-000 1-conductor female plug; angled; 4 mm²; 11-pole; 4,00 mm²; gray</p>	www.wago.com/769-111/022-000
	<p>Item no.: 769-112 1-conductor female plug; 4 mm²; 12-pole; 4,00 mm²; gray</p>	www.wago.com/769-112
	<p>Item no.: 769-112/000-006 1-conductor female plug; 4 mm²; 12-pole; 4,00 mm²; blue</p>	www.wago.com/769-112/000-006
	<p>Item no.: 769-112/000-036 1-conductor female plug; 4 mm²; 12-pole; 4,00 mm²; gray, green-yellow</p>	www.wago.com/769-112/000-036
	<p>Item no.: 769-112/000-037 1-conductor female plug; 4 mm²; 12-pole; 4,00 mm²; green-yellow, gray</p>	www.wago.com/769-112/000-037
	<p>Item no.: 769-112/000-038 1-conductor female plug; 4 mm²; 12-pole; 4,00 mm²; gray, blue, green-yellow</p>	www.wago.com/769-112/000-038













Subject to changes. Please also observe the further product documentation!

	Item no.: 769-112/000-039 1-conductor female plug; 4 mm²; 12-pole; 4,00 mm²; green-yellow, blue, gray	www.wago.com/769-112/000-039
	Item no.: 769-112/022-000 1-conductor female plug; angled; 4 mm²; 12-pole; 4,00 mm²; gray	www.wago.com/769-112/022-000
	Item no.: 769-113 1-conductor female plug; 4 mm²; 13-pole; 4,00 mm²; gray	www.wago.com/769-113
	Item no.: 769-113/000-036 1-conductor female plug; 4 mm²; 13-pole; 4,00 mm²; gray, green-yellow	www.wago.com/769-113/000-036
	Item no.: 769-113/000-037 1-conductor female plug; 4 mm²; 13-pole; 4,00 mm²; green-yellow, gray	www.wago.com/769-113/000-037
	Item no.: 769-113/000-038 1-conductor female plug; 4 mm²; 13-pole; 4,00 mm²; gray, blue, green-yellow	www.wago.com/769-113/000-038
	Item no.: 769-113/000-039 1-conductor female plug; 4 mm²; 13-pole; 4,00 mm²; green-yellow, blue, gray	www.wago.com/769-113/000-039
	Item no.: 769-113/022-000 1-conductor female plug; angled; 4 mm²; 13-pole; 4,00 mm²; gray	www.wago.com/769-113/022-000
	Item no.: 769-114 1-conductor female plug; 4 mm²; 14-pole; 4,00 mm²; gray	www.wago.com/769-114
	Item no.: 769-114/000-006 1-conductor female plug; 4 mm²; 14-pole; 4,00 mm²; blue	www.wago.com/769-114/000-006
	Item no.: 769-114/000-036 1-conductor female plug; 4 mm²; 14-pole; 4,00 mm²; gray, green-yellow	www.wago.com/769-114/000-036
	Item no.: 769-114/000-037 1-conductor female plug; 4 mm²; 14-pole; 4,00 mm²; green-yellow, gray	www.wago.com/769-114/000-037
	Item no.: 769-114/000-038 1-conductor female plug; 4 mm²; 14-pole; 4,00 mm²; gray, blue, green-yellow	www.wago.com/769-114/000-038
	Item no.: 769-114/000-039 1-conductor female plug; 4 mm²; 14-pole; 4,00 mm²; green-yellow, blue, gray	www.wago.com/769-114/000-039















Subject to changes. Please also observe the further product documentation!

	Item no.: 769-114/022-000 1-conductor female plug; angled; 4 mm²; 14-pole; 4,00 mm²; gray	www.wago.com/769-114/022-000
	Item no.: 769-115 1-conductor female plug; 4 mm²; 15-pole; 4,00 mm²; gray	www.wago.com/769-115
	Item no.: 769-115/000-036 1-conductor female plug; 4 mm²; 15-pole; 4,00 mm²; gray, green-yellow	www.wago.com/769-115/000-036
	Item no.: 769-115/000-037 1-conductor female plug; 4 mm²; 15-pole; 4,00 mm²; green-yellow, gray	www.wago.com/769-115/000-037
	Item no.: 769-115/000-038 1-conductor female plug; 4 mm²; 15-pole; 4,00 mm²; gray, blue, green-yellow	www.wago.com/769-115/000-038
	Item no.: 769-115/000-039 1-conductor female plug; 4 mm²; 15-pole; 4,00 mm²; green-yellow, blue, gray	www.wago.com/769-115/000-039
	Item no.: 769-115/022-000 1-conductor female plug; angled; 4 mm²; 15-pole; 4,00 mm²; gray	www.wago.com/769-115/022-000
	Item no.: 769-121 2-conductor female connector; 4 mm²; 1-pole; 4,00 mm²; gray	www.wago.com/769-121
	Item no.: 769-121/000-016 2-conductor female connector; 4 mm²; 1-pole; 4,00 mm²; green-yellow	www.wago.com/769-121/000-016
	Item no.: 769-122 2-conductor female connector; 4 mm²; 2-pole; 4,00 mm²; gray	www.wago.com/769-122
	Item no.: 769-123 2-conductor female connector; 4 mm²; 3-pole; 4,00 mm²; gray	www.wago.com/769-123
	Item no.: 769-124 2-conductor female connector; 4 mm²; 4-pole; 4,00 mm²; gray	www.wago.com/769-124
	Item no.: 769-125 2-conductor female connector; 4 mm²; 5-pole; 4,00 mm²; gray	www.wago.com/769-125
	Item no.: 769-126 2-conductor female connector; 4 mm²; 6-pole; 4,00 mm²; gray	www.wago.com/769-126
	Item no.: 769-127 2-conductor female connector; 4 mm²; 7-pole; 4,00 mm²; gray	www.wago.com/769-127
	Item no.: 769-128 2-conductor female connector; 4 mm²; 8-pole; 4,00 mm²; gray	www.wago.com/769-128

Subject to changes. Please also observe the further product documentation!

	Item no.: 769-129 2-conductor female connector; 4 mm²; 9-pole; 4,00 mm²; gray	www.wago.com/769-129
	Item no.: 769-130 2-conductor female connector; 4 mm²; 10-pole; 4,00 mm²; gray	www.wago.com/769-130
	Item no.: 769-131 2-conductor female connector; 4 mm²; 11-pole; 4,00 mm²; gray	www.wago.com/769-131
	Item no.: 769-132 2-conductor female connector; 4 mm²; 12-pole; 4,00 mm²; gray	www.wago.com/769-132
	Item no.: 769-133 2-conductor female connector; 4 mm²; 13-pole; 4,00 mm²; gray	www.wago.com/769-133
	Item no.: 769-134 2-conductor female connector; 4 mm²; 14-pole; 4,00 mm²; gray	www.wago.com/769-134
	Item no.: 769-135 2-conductor female connector; 4 mm²; 15-pole; 4,00 mm²; gray	www.wago.com/769-135
assembling		
	Item no.: 209-106 Mounting carrier; for isolated mounting on DIN 35 rails; gray	www.wago.com/209-106
Carrier rail		
	Item no.: 210-112 Steel carrier rail; 35 x 7.5 mm; 1 mm thick; 2 m long; slotted; according to EN 60715; "Hole width 25 mm	www.wago.com/210-112
	Item no.: 210-113 Steel carrier rail; 35 x 7.5 mm; 1 mm thick; 2 m long; unslotted; according to EN 60715	www.wago.com/210-113
	Item no.: 210-114 Steel carrier rail; 35 x 15 mm; 1.5 mm thick; 2 m long; unslotted; similar to EN 60715	www.wago.com/210-114
	Item no.: 210-115 Steel carrier rail; 35 x 7.5 mm; 1 mm thick; 2 m long; slotted; according to EN 60715; "Hole width 18 mm	www.wago.com/210-115
	Item no.: 210-118 Steel carrier rail; 35 x 15 mm; 2.3 mm thick; 2 m long; unslotted; according to EN 60715	www.wago.com/210-118
	Item no.: 210-196 Aluminum carrier rail; 35 x 8.2 mm; 1.6 mm thick; 2 m long; unslotted; similar to EN 60715; silver-colored	www.wago.com/210-196
	Item no.: 210-197 Steel carrier rail; 35 x 15 mm; 1.5 mm thick; 2 m long; slotted; similar to EN 60715	www.wago.com/210-197
	Item no.: 210-198 Copper carrier rail; 35 x 15 mm; 2.3 mm thick; 2 m long; unslotted; according to EN 60715; copper-colored	www.wago.com/210-198
	Item no.: 210-504 Steel carrier rail; 35 x 7.5 mm; 1 mm thick; 2 m long; slotted; galvanized; according to EN 60715	www.wago.com/210-504

Subject to changes. Please also observe the further product documentation!

	Item no.: 210-505 Steel carrier rail; 35 x 7.5 mm; 1 mm thick; 2 m long; unslotted; galvanized; according to EN 60715	www.wago.com/210-505
	Item no.: 210-506 Steel carrier rail; 35 x 15 mm; 1.5 mm thick; 2 m long; unslotted; galvanized; similar to EN 60715	www.wago.com/210-506
	Item no.: 210-508 Steel carrier rail; 35 x 15 mm; 1.5 mm thick; 2 m long; slotted; galvanized; similar to EN 60715	www.wago.com/210-508
Jumper		
	Item no.: 249-123 Push-in type wire jumper; insulated; wire length 180 mm; Conductor cross section 0.75 mm ²	www.wago.com/249-123
	Item no.: 249-125 Push-in type wire jumper; insulated; wire length 60 mm; Conductor cross section 0.75 mm ²	www.wago.com/249-125
	Item no.: 249-126 Push-in type wire jumper; insulated; wire length 110 mm; Conductor cross section 0.75 mm ²	www.wago.com/249-126
	Item no.: 249-127 Push-in type wire jumper; insulated; wire length 250 mm; Conductor cross section 0.75 mm ²	www.wago.com/249-127
	Item no.: 280-402 Adjacent jumper; insulated; IN = IN terminal block; gray	www.wago.com/280-402
	Item no.: 280-409 Alternate jumper; insulated; IN = IN terminal block; gray	www.wago.com/280-409
	Item no.: 780-452 Staggered jumper; insulated; from 1 to 2; Spacing: 5 mm; suitable for 2-conductor female plugs; gray	www.wago.com/780-452
	Item no.: 780-453 Staggered jumper; insulated; from 1 to 3; Spacing: 5 mm; suitable for 2-conductor female plugs; gray	www.wago.com/780-453
	Item no.: 780-454 Staggered jumper; insulated; from 1 to 4; Spacing: 5 mm; suitable for 2-conductor female plugs; gray	www.wago.com/780-454
	Item no.: 780-455 Staggered jumper; insulated; from 1 to 5; Spacing: 5 mm; suitable for 2-conductor female plugs; gray	www.wago.com/780-455
	Item no.: 780-456 Staggered jumper; insulated; from 1 to 6; Spacing: 5 mm; suitable for 2-conductor female plugs; gray	www.wago.com/780-456
	Item no.: 780-457 Staggered jumper; insulated; from 1 to 7; Spacing: 5 mm; suitable for 2-conductor female plugs; gray	www.wago.com/780-457
	Item no.: 780-458 Staggered jumper; insulated; from 1 to 8; Spacing: 5 mm; suitable for 2-conductor female plugs; gray	www.wago.com/780-458
Coding		
	Item no.: 769-435 Coding pin; for coding of female plugs; for carrier terminal blocks / male connectors; orange	www.wago.com/769-435

tools

Subject to changes. Please also observe the further product documentation!



Item no.: 210-720
Operating tool; Blade: 3.5 x 0.5 mm; with a partially insulated shaft

www.wago.com/210-720

Test Accessories



Item no.: 210-137
Test plug; 2.3 mm Ø; with 500 mm cable; yellow

www.wago.com/210-137

Item no.: 280-404
Test plug adapter; 5 mm wide; for test plug 210-137 (2.3 mm Ø); suitable for 1.5 mm² - 4 mm² tbs; gray

www.wago.com/280-404



Item no.: 280-418
Test plug module; modular; suitable for all WAGO 280 and 780 Series rail-mounted terminal blocks with jumper slots in the current bar; gray

www.wago.com/280-418

Item no.: 280-419
Spacer module; modular; bridging commoned terminal blocks; gray

www.wago.com/280-419

General accessories



Item no.: 709-170
Disconnect lock; for disconnect tab used on 280/281 and 769 Series disconnect terminal blocks; red

www.wago.com/709-170



Item no.: 769-438
Pin cover; with marker slot for miniature WSB; gray

www.wago.com/769-438



Item no.: 769-439
Pin cover; with marker slot for miniature WSB; orange

www.wago.com/769-439



Item no.: 769-501
Start module for 1-conductor female connector; with integrated end plate; 4 mm²; 1-pole; 4,00 mm²; gray

www.wago.com/769-501



Item no.: 769-501/000-006
Start module for 1-conductor female connector; 4 mm²; 1-pole; 4,00 mm²; blue

www.wago.com/769-501/000-006



Item no.: 769-501/000-016
Start module for 1-conductor female connector; with integrated end plate; 4 mm²; 1-pole; 4,00 mm²; green-yellow

www.wago.com/769-501/000-016



Item no.: 769-502
Center module for 1-conductor female connector; 4 mm²; 1-pole; 4,00 mm²; gray

www.wago.com/769-502



Item no.: 769-502/000-006
Center module for 1-conductor female connector; 4 mm²; 1-pole; 4,00 mm²; blue

www.wago.com/769-502/000-006



Item no.: 769-502/000-016
Center module for 1-conductor female connector; 4 mm²; 1-pole; 4,00 mm²; green-yellow













www.wago.com/769-502/000-016



Item no.: 769-503
End module for 1-conductor female connector; 4 mm²; 1-pole; 4,00 mm²; gray

www.wago.com/769-503

Subject to changes. Please also observe the further product documentation!

	<p>Item no.: 769-503/000-006 End module for 1-conductor female connector; 4 mm²; 1-pole; 4,00 mm²; blue</p>	www.wago.com/769-503/000-006
	<p>Item no.: 769-503/000-016 End module for 1-conductor female connector; 4 mm²; 1-pole; 4,00 mm²; green-yellow</p>	www.wago.com/769-503/000-016
	<p>Item no.: 769-504 Start module for 2-conductor female connector; with integrated end plate; 4 mm²; 1-pole; 4,00 mm²; gray</p>	www.wago.com/769-504
	<p>Item no.: 769-504/000-006 Start module for 2-conductor female connector; with integrated end plate; 4 mm²; 1-pole; 4,00 mm²; blue</p>	www.wago.com/769-504/000-006
	<p>Item no.: 769-504/000-016 Start module for 2-conductor female connector; 4 mm²; 1-pole; 4,00 mm²; green-yellow</p>	www.wago.com/769-504/000-016
	<p>Item no.: 769-505 Center module for 2-conductor female connector; 4 mm²; 1-pole; 4,00 mm²; gray</p>	www.wago.com/769-505
	<p>Item no.: 769-505/000-006 Center module for 2-conductor female connector; 4 mm²; 1-pole; 4,00 mm²; blue</p>	www.wago.com/769-505/000-006
	<p>Item no.: 769-505/000-016 Center module for 2-conductor female connector; 4 mm²; 1-pole; 4,00 mm²; green-yellow</p>	www.wago.com/769-505/000-016
	<p>Item no.: 769-506 End module for 2-conductor female connector; 4 mm²; 1-pole; 4,00 mm²; gray</p>	www.wago.com/769-506
	<p>Item no.: 769-506/000-006 End module for 2-conductor female connector; 4 mm²; 1-pole; 4,00 mm²; blue</p>	www.wago.com/769-506/000-006
	<p>Item no.: 769-506/000-016 End module for 2-conductor female connector; 4 mm²; 1-pole; 4,00 mm²; green-yellow</p>	www.wago.com/769-506/000-016
	<p>Item no.: 769-512 Start module for 1-conductor female connector; angled; 4 mm²; 1-pole; 4,00 mm²; gray</p>	www.wago.com/769-512
	<p>Item no.: 769-512/000-006 Start module for 1-conductor female connector; angled; 4 mm²; 1-pole; 4,00 mm²; blue</p>	www.wago.com/769-512/000-006
	<p>Item no.: 769-512/000-016 Start module for 1-conductor female connector; angled; 4 mm²; 1-pole; 4,00 mm²; green-yellow</p>	www.wago.com/769-512/000-016
	<p>Item no.: 769-513 Center module for 1-conductor female connector; angled; 4 mm²; 1-pole; 4,00 mm²; gray</p>	www.wago.com/769-513

Subject to changes. Please also observe the further product documentation!



Item no.: 769-513/000-006 Center module for 1-conductor female connector; angled; 4 mm ² ; 1-pole; 4,00 mm ² ; blue	www.wago.com/769-513/000-006
Item no.: 769-513/000-016 Center module for 1-conductor female connector; angled; 4 mm ² ; 1-pole; 4,00 mm ² ; green-yellow	www.wago.com/769-513/000-016
Item no.: 769-515 End module for 1-conductor female connector; angled; 4 mm ² ; 1-pole; 4,00 mm ² ; gray	www.wago.com/769-515
Item no.: 769-515/000-006 End module for 1-conductor female connector; angled; 4 mm ² ; 1-pole; 4,00 mm ² ; blue	www.wago.com/769-515/000-006
Item no.: 769-515/000-016 End module for 1-conductor female connector; angled; 4 mm ² ; 1-pole; 4,00 mm ² ; green-yellow	www.wago.com/769-515/000-016

Downloads

Documentation

Additional Information

Technical explanations	Apr 3, 2019	pdf 2.1 MB	Download
------------------------	-------------	---------------	----------

CAD/CAE-Data

CAD data

2D/3D Models 769-202	URL	Download
----------------------	-----	----------

CAE data

EPLAN Data Portal 769-202	URL	Download
WSCAD Universe 769-202	URL	Download

Installation Notes

Assembly

Subject to changes. Please also observe the further product documentation!

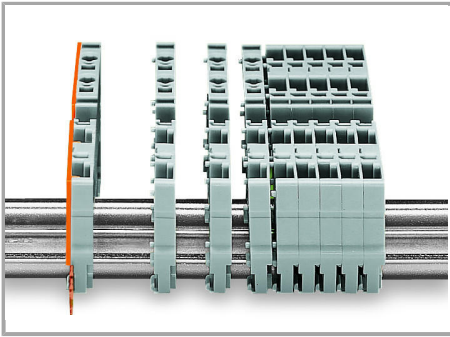

Snap individual carrier terminal blocks onto the carrier rail and slide together.

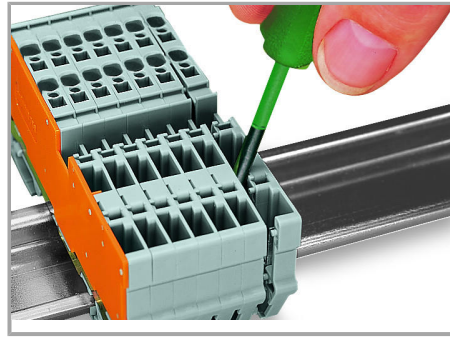

Open the assembly by laterally sliding a block via operating tool and remove terminal block via release lever.

Jumpered

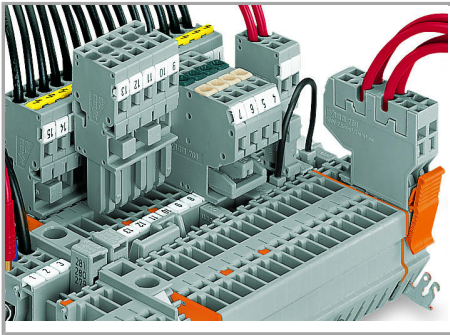

Commoning with adjacent or staggered jumpers –

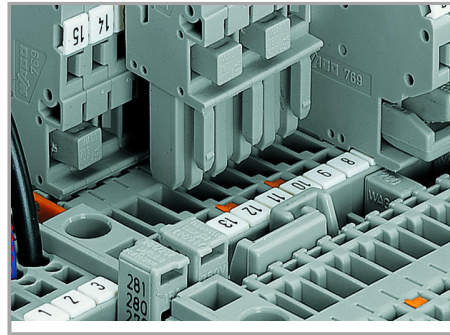

Commoning carrier terminal blocks via staggered jumpers.

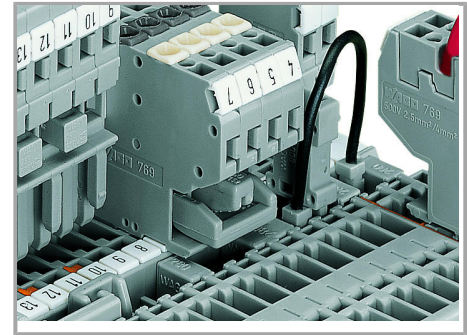

Commoning a 2-conductor female plug via staggered jumper and carrier terminal blocks via adjacent jumpers.

push jumpers down until fully inserted.

Subject to changes. Please also observe the further product documentation!

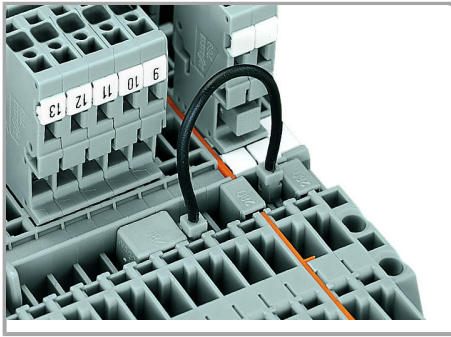

Commoning carrier terminal blocks via push-in type wire jumpers or adjacent jumpers – even over an intermediate plate.

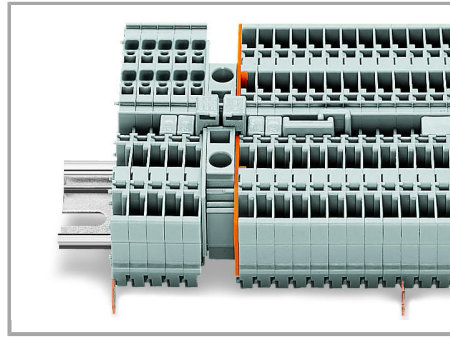

Commoning “supply terminal blocks” (up to 10 mm²/8 AWG) with carrier terminal blocks via step-down jumpers.

Testing

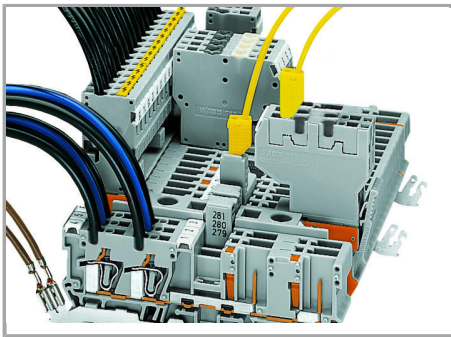

Testing via 2 or 2.3 mm Ø test plugs.

Coding

Subject to changes. Please also observe the further product documentation!

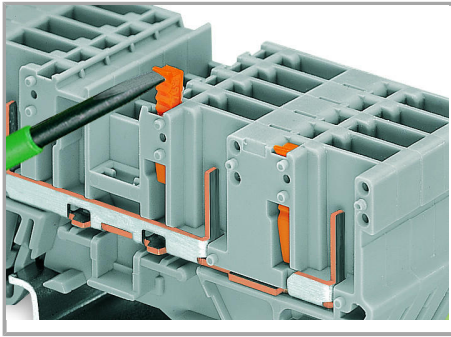

Snap coding pin in proper direction on carrier terminal block.

Shown: Coding pin removal from carrier terminal block.

Locking

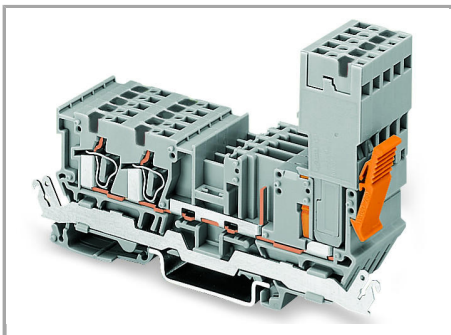

Female plug secured with locking lever on the terminal block side.

Subject to changes. Please also observe the further product documentation!

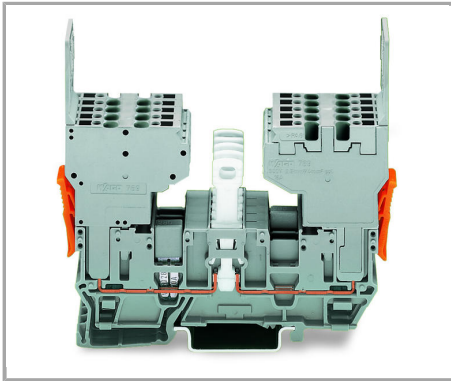

2-conductor female plug

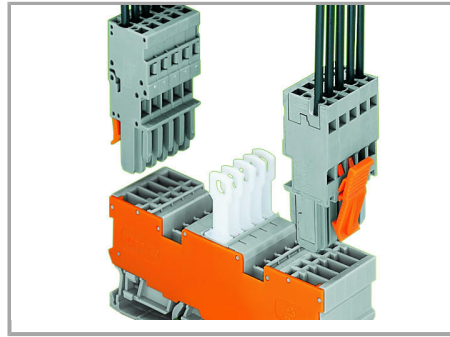

2-pin disconnect carrier terminal block with two jumper positions

Disconnect carrier terminal blocks can be commoned via 280 and 780 Series Jumpers.

1-conductor female plug, straight*

*1-conductor angled female plug is also possible!

Safety

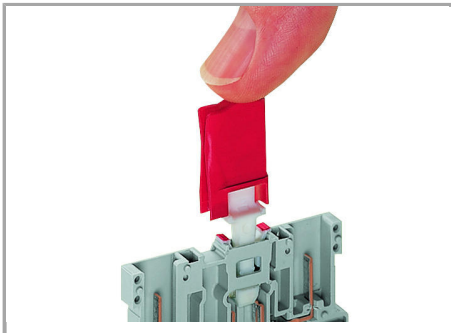

Installing a disconnect lock on the terminal block's disconnect tab.

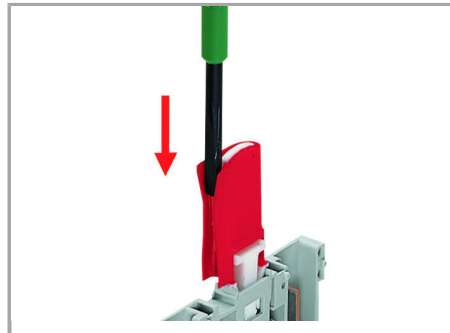

Unlocking a disconnect lock.

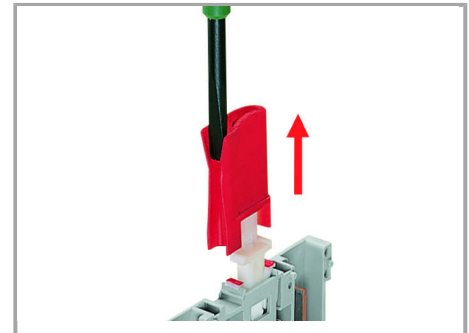

Removing a disconnect lock.

Product family

X-COM

[Learn more about the product family.](#)

[Show all products from the family](#)

Subject to changes. Please also observe the further product documentation!