

## Data sheet | Item number: 769-181

1-conductor/1-pin carrier terminal block; with 2 jumper positions; for DIN-rail  
35 x 15 and 35 x 7.5; 4 mm<sup>2</sup>; CAGE CLAMP®; 4,00 mm<sup>2</sup>; gray

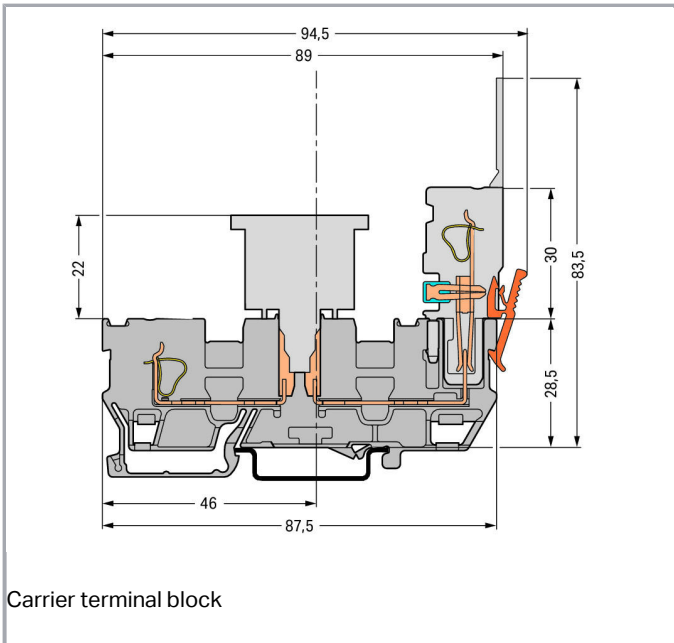

[www.wago.com/769-181](http://www.wago.com/769-181)

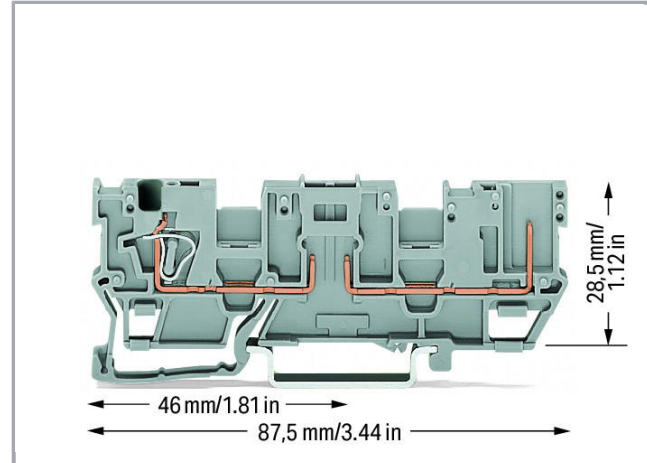
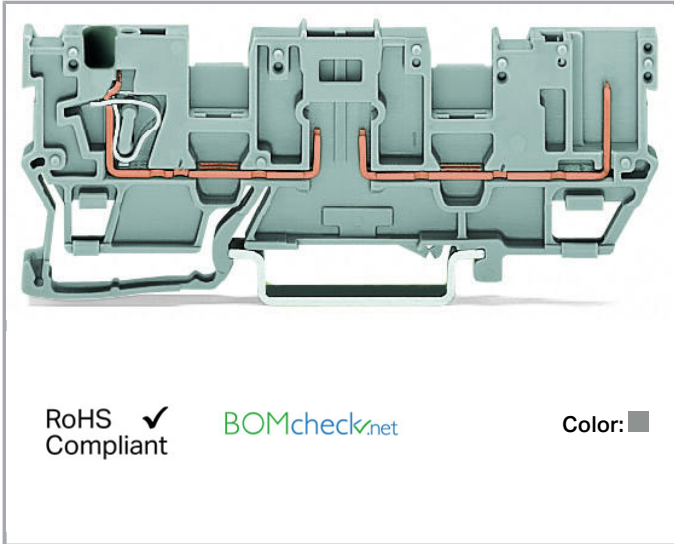

### Item description

#### Safety information 1:

2-conductor female plugs cannot be used.

Subject to changes. Please also observe the further product documentation!

WAGO Kontakttechnik GmbH & Co. KG  
Hansastr. 27  
32423 Minden  
Phone: +49571 887-0 | Fax: +49571 887-169  
Email: [info.de@wago.com](mailto:info.de@wago.com) | Web: [www.wago.com](http://www.wago.com)

Do you have any questions about our products?  
We are always happy to take your call at +49 (571) 887-44222.



## Data

### Electrical data

#### Ratings per IEC/EN 60664-1

Rated voltage (III / 3)	400 V
Rated impulse voltage (III / 3)	6 kV
Rated current	16 A
Legend (ratings)	(III / 3) $\hat{=}$ Overvoltage category III / Pollution degree 3

### Connection data

Connection technology	CAGE CLAMP®
Actuation type	Open Tool Slot
Connectable conductor materials	Copper
Nominal cross section	4 mm <sup>2</sup>
Solid conductor	0,08 ... 4 mm <sup>2</sup> / 28 ... 12 AWG
Fine-stranded conductor	0,08 ... 4 mm <sup>2</sup> / 28 ... 12 AWG
Strip length	8 ... 9 mm / 0.31 ... 0.35 inch
No. of poles	2
Total number of connection points	1
Total number of potentials	2
Number of levels	1
Type of wiring	Front-entry wiring

### Geometrical Data

Width	5 mm / 0.197 inch
Height from upper-edge of DIN-35 rail	28,5 mm / 1.122 inch
Depth	87,5 mm / 3.445 inch

### Mechanical data

Design	horizontal
Type of mounting	DIN-35 rail
Marking level	Center marking

### Material Data

Color	gray
-------	------

Subject to changes. Please also observe the further product documentation!



Insulating material	Polyamide 66 (PA 66)
Fire load	0.168 MJ
Weight	8 g

### Commercial data



Product Group	18 (X-COM-System)
Packaging type	BOX
Country of origin	DE
GTIN	4044918934725
Customs Tariff No.	85369010000

### Approvals / Certificates

#### Country specific Approvals

Logo	Approval	Additional Approval Text	Certificate name
	<b>CCA</b> DEKRA Certification B.V.	EN 60947	NTR NL-7626
	<b>CSA</b> DEKRA Certification B.V.	C22.2 No. 158	1101144
	<b>KEMA/KEUR</b> DEKRA Certification B.V.	EN 60947	2190419.01



#### Ship Approvals

Logo	Approval	Additional Approval Text	Certificate name
	<b>ABS</b> American Bureau of Shipping	EN 60947	20-HG1941090-PDA
	<b>DNV GL</b> Det Norske Veritas, Germanischer Lloyd	-	TAE00001V2
	<b>LR</b> Lloyds Register	EN 60947	91/20112 (E9)

Subject to changes. Please also observe the further product documentation!



## UL-Approvals

Logo	Approval	Additional Approval Text	Certificate name
	UR Underwriters Laboratories Inc.	UL 1059	20190731-E45172
	UR Underwriters Laboratories Inc.	UL 1977	20151210-E45171

## Counterpart

## Compatible products

## Carrier rail

**Item no.: 210-112**Steel carrier rail; 35 x 7.5 mm; 1 mm thick; 2 m long; slotted; according to EN 60715; "Hole width 25 mm [www.wago.com/210-112](http://www.wago.com/210-112)**Item no.: 210-113**Steel carrier rail; 35 x 7.5 mm; 1 mm thick; 2 m long; unslotted; according to EN 60715 [www.wago.com/210-113](http://www.wago.com/210-113)**Item no.: 210-114**Steel carrier rail; 35 x 15 mm; 1.5 mm thick; 2 m long; unslotted; similar to EN 60715 [www.wago.com/210-114](http://www.wago.com/210-114)**Item no.: 210-115**

Subject to changes. Please also observe the further product documentation!

WAGO Kontakttechnik GmbH &amp; Co. KG

Hansastr. 27











32423 Minden

Phone: +49571 887-0 | Fax: +49571 887-169











Email: [info.de@wago.com](mailto:info.de@wago.com) | Web: [www.wago.com](http://www.wago.com)

Do you have any questions about our products?













We are always happy to take your call at +49 (571) 887-44222.

	Steel carrier rail; 35 x 7.5 mm; 1 mm thick; 2 m long; slotted; according to EN 60715; "Hole width 18 mm	<a href="http://www.wago.com/210-115">www.wago.com/210-115</a>
	<b>Item no.: 210-118</b> Steel carrier rail; 35 x 15 mm; 2.3 mm thick; 2 m long; unslotted; according to EN 60715	<a href="http://www.wago.com/210-118">www.wago.com/210-118</a>
	<b>Item no.: 210-196</b> Aluminum carrier rail; 35 x 8.2 mm; 1.6 mm thick; 2 m long; unslotted; similar to EN 60715; silver-colored	<a href="http://www.wago.com/210-196">www.wago.com/210-196</a>
	<b>Item no.: 210-197</b> Steel carrier rail; 35 x 15 mm; 1.5 mm thick; 2 m long; slotted; similar to EN 60715	<a href="http://www.wago.com/210-197">www.wago.com/210-197</a>
	<b>Item no.: 210-198</b> Copper carrier rail; 35 x 15 mm; 2.3 mm thick; 2 m long; unslotted; according to EN 60715; copper-colored	<a href="http://www.wago.com/210-198">www.wago.com/210-198</a>
	<b>Item no.: 210-504</b> Steel carrier rail; 35 x 7.5 mm; 1 mm thick; 2 m long; slotted; galvanized; according to EN 60715	<a href="http://www.wago.com/210-504">www.wago.com/210-504</a>
	<b>Item no.: 210-505</b> Steel carrier rail; 35 x 7.5 mm; 1 mm thick; 2 m long; unslotted; galvanized; according to EN 60715	<a href="http://www.wago.com/210-505">www.wago.com/210-505</a>
	<b>Item no.: 210-506</b> Steel carrier rail; 35 x 15 mm; 1.5 mm thick; 2 m long; unslotted; galvanized; similar to EN 60715	<a href="http://www.wago.com/210-506">www.wago.com/210-506</a>
	<b>Item no.: 210-508</b> Steel carrier rail; 35 x 15 mm; 1.5 mm thick; 2 m long; slotted; galvanized; similar to EN 60715	<a href="http://www.wago.com/210-508">www.wago.com/210-508</a>
<b>Coding</b>		
	<b>Item no.: 769-435</b> Coding pin; for coding of female plugs; for carrier terminal blocks / male connectors; orange	<a href="http://www.wago.com/769-435">www.wago.com/769-435</a>
<b>ferrule</b>		
	<b>Item no.: 216-101</b> Ferrule; Sleeve for 0.5 mm <sup>2</sup> / AWG 22; uninsulated; electro-tin plated	<a href="http://www.wago.com/216-101">www.wago.com/216-101</a>
	<b>Item no.: 216-102</b> Ferrule; Sleeve for 0.75 mm <sup>2</sup> / AWG 20; uninsulated; electro-tin plated	<a href="http://www.wago.com/216-102">www.wago.com/216-102</a>
	<b>Item no.: 216-103</b> Ferrule; Sleeve for 1 mm <sup>2</sup> / AWG 18; uninsulated; electro-tin plated	<a href="http://www.wago.com/216-103">www.wago.com/216-103</a>
	<b>Item no.: 216-104</b> Ferrule; Sleeve for 1.5 mm <sup>2</sup> / AWG 16; uninsulated; electro-tin plated	<a href="http://www.wago.com/216-104">www.wago.com/216-104</a>
	<b>Item no.: 216-201</b> Ferrule; Sleeve for 0.5 mm <sup>2</sup> / 20 AWG; insulated; electro-tin plated; white	<a href="http://www.wago.com/216-201">www.wago.com/216-201</a>
	<b>Item no.: 216-202</b> Ferrule; Sleeve for 0.75 mm <sup>2</sup> / 18 AWG; insulated; electro-tin plated; gray	<a href="http://www.wago.com/216-202">www.wago.com/216-202</a>
	<b>Item no.: 216-203</b> Ferrule; Sleeve for 1 mm <sup>2</sup> / AWG 18; insulated; electro-tin plated; red	<a href="http://www.wago.com/216-203">www.wago.com/216-203</a>











Subject to changes. Please also observe the further product documentation!

	<b>Item no.: 216-204</b> Ferrule; Sleeve for 1.5 mm <sup>2</sup> / AWG 16; insulated; electro-tin plated; black	<a href="http://www.wago.com/216-204">www.wago.com/216-204</a>
	<b>Item no.: 216-206</b> Ferrule; Sleeve for 2.5 mm <sup>2</sup> / AWG 14; insulated; electro-tin plated; blue	<a href="http://www.wago.com/216-206">www.wago.com/216-206</a>
	<b>Item no.: 216-301</b> Ferrule; Sleeve for 0.25 mm <sup>2</sup> / AWG 24; insulated; electro-tin plated; yellow	<a href="http://www.wago.com/216-301">www.wago.com/216-301</a>
	<b>Item no.: 216-302</b> Ferrule; Sleeve for 0.34 mm <sup>2</sup> / 22 AWG; insulated; electro-tin plated; green	<a href="http://www.wago.com/216-302">www.wago.com/216-302</a>
<b>Test Accessories</b>		
	<b>Item no.: 210-136</b> Test plug; 2 mm Ø; with 500 mm cable; red	<a href="http://www.wago.com/210-136">www.wago.com/210-136</a>
	<b>Item no.: 210-137</b> Test plug; 2.3 mm Ø; with 500 mm cable; yellow	<a href="http://www.wago.com/210-137">www.wago.com/210-137</a>
	<b>Item no.: 280-404</b> Test plug adapter; 5 mm wide; for test plug 210-137 (2.3 mm Ø); suitable for 1.5 mm <sup>2</sup> - 4 mm <sup>2</sup> tbs; gray	<a href="http://www.wago.com/280-404">www.wago.com/280-404</a>
	<b>Item no.: 280-418</b> Test plug module; modular; suitable for all WAGO 280 and 780 Series rail-mounted terminal blocks with jumper slots in the current bar; gray	<a href="http://www.wago.com/280-418">www.wago.com/280-418</a>
	<b>Item no.: 280-419</b> Spacer module; modular; bridging commoned terminal blocks; gray	<a href="http://www.wago.com/280-419">www.wago.com/280-419</a>
<b>Protective Warning Marker</b>		
	<b>Item no.: 280-415</b> Protective warning marker; with high-voltage symbol, black; for 5 terminal blocks; yellow	<a href="http://www.wago.com/280-415">www.wago.com/280-415</a>
<b>tools</b>		
	<b>Item no.: 210-720</b> Operating tool; Blade: 3.5 x 0.5 mm; with a partially insulated shaft	<a href="http://www.wago.com/210-720">www.wago.com/210-720</a>
<b>Female plug</b>		
	<b>Item no.: 769-101</b> 1-conductor female plug; 4 mm <sup>2</sup> ; 1-pole; 4,00 mm <sup>2</sup> ; gray	<a href="http://www.wago.com/769-101">www.wago.com/769-101</a>
	<b>Item no.: 769-101/000-006</b> 1-conductor female plug; 4 mm <sup>2</sup> ; 1-pole; 4,00 mm <sup>2</sup> ; blue	<a href="http://www.wago.com/769-101/000-006">www.wago.com/769-101/000-006</a>
	<b>Item no.: 769-101/000-016</b> 1-conductor female plug; 4 mm <sup>2</sup> ; 1-pole; 4,00 mm <sup>2</sup> ; green-yellow	<a href="http://www.wago.com/769-101/000-016">www.wago.com/769-101/000-016</a>
	<b>Item no.: 769-101/022-000</b> 1-conductor female plug; angled; 4 mm <sup>2</sup> ; 1-pole; 4,00 mm <sup>2</sup> ; gray	<a href="http://www.wago.com/769-101/022-000">www.wago.com/769-101/022-000</a>

Subject to changes. Please also observe the further product documentation!

	<p><b>Item no.: 769-101/022-016</b> 1-conductor female plug; angled; 4 mm<sup>2</sup>; 1-pole; 4,00 mm<sup>2</sup>; green-yellow</p>	<a href="http://www.wago.com/769-101/022-016">www.wago.com/769-101/022-016</a>
	<p><b>Item no.: 769-102</b> 1-conductor female plug; 4 mm<sup>2</sup>; 2-pole; 4,00 mm<sup>2</sup>; gray</p>	<a href="http://www.wago.com/769-102">www.wago.com/769-102</a>
	<p><b>Item no.: 769-102/000-006</b> 1-conductor female plug; 4 mm<sup>2</sup>; 2-pole; 4,00 mm<sup>2</sup>; blue</p>	<a href="http://www.wago.com/769-102/000-006">www.wago.com/769-102/000-006</a>
	<p><b>Item no.: 769-102/000-036</b> 1-conductor female plug; 4 mm<sup>2</sup>; 2-pole; 4,00 mm<sup>2</sup>; gray, green-yellow</p>	<a href="http://www.wago.com/769-102/000-036">www.wago.com/769-102/000-036</a>
	<p><b>Item no.: 769-102/000-037</b> 1-conductor female plug; 4 mm<sup>2</sup>; 2-pole; 4,00 mm<sup>2</sup>; green-yellow, gray</p>	<a href="http://www.wago.com/769-102/000-037">www.wago.com/769-102/000-037</a>
	<p><b>Item no.: 769-102/022-000</b> 1-conductor female plug; angled; 4 mm<sup>2</sup>; 2-pole; 4,00 mm<sup>2</sup>; gray</p>	<a href="http://www.wago.com/769-102/022-000">www.wago.com/769-102/022-000</a>
	<p><b>Item no.: 769-103</b> 1-conductor female plug; 4 mm<sup>2</sup>; 3-pole; 4,00 mm<sup>2</sup>; gray</p>	<a href="http://www.wago.com/769-103">www.wago.com/769-103</a>
	<p><b>Item no.: 769-103/000-006</b> 1-conductor female plug; 4 mm<sup>2</sup>; 3-pole; 4,00 mm<sup>2</sup>; blue</p>	<a href="http://www.wago.com/769-103/000-006">www.wago.com/769-103/000-006</a>
	<p><b>Item no.: 769-103/000-036</b> 1-conductor female plug; 4 mm<sup>2</sup>; 3-pole; 4,00 mm<sup>2</sup>; gray, green-yellow</p>	<a href="http://www.wago.com/769-103/000-036">www.wago.com/769-103/000-036</a>
	<p><b>Item no.: 769-103/000-037</b> 1-conductor female plug; 4 mm<sup>2</sup>; 3-pole; 4,00 mm<sup>2</sup>; green-yellow, gray</p>	<a href="http://www.wago.com/769-103/000-037">www.wago.com/769-103/000-037</a>
	<p><b>Item no.: 769-103/000-038</b> 1-conductor female plug; 4 mm<sup>2</sup>; 3-pole; 4,00 mm<sup>2</sup>; gray, blue, green-yellow</p>	<a href="http://www.wago.com/769-103/000-038">www.wago.com/769-103/000-038</a>
	<p><b>Item no.: 769-103/000-039</b> 1-conductor female plug; 4 mm<sup>2</sup>; 3-pole; 4,00 mm<sup>2</sup>; green-yellow, blue, gray</p>	<a href="http://www.wago.com/769-103/000-039">www.wago.com/769-103/000-039</a>
	<p><b>Item no.: 769-103/022-000</b> 1-conductor female plug; angled; 4 mm<sup>2</sup>; 3-pole; 4,00 mm<sup>2</sup>; gray</p>	<a href="http://www.wago.com/769-103/022-000">www.wago.com/769-103/022-000</a>
	<p><b>Item no.: 769-104</b> 1-conductor female plug; 4 mm<sup>2</sup>; 4-pole; 4,00 mm<sup>2</sup>; gray</p>	<a href="http://www.wago.com/769-104">www.wago.com/769-104</a>

Subject to changes. Please also observe the further product documentation!

	<p><b>Item no.: 769-104/000-006</b> 1-conductor female plug; 4 mm<sup>2</sup>; 4-pole; 4,00 mm<sup>2</sup>; blue</p>	<a href="http://www.wago.com/769-104/000-006">www.wago.com/769-104/000-006</a>
	<p><b>Item no.: 769-104/000-036</b> 1-conductor female plug; 4 mm<sup>2</sup>; 4-pole; 4,00 mm<sup>2</sup>; gray, green-yellow</p>	<a href="http://www.wago.com/769-104/000-036">www.wago.com/769-104/000-036</a>
	<p><b>Item no.: 769-104/000-037</b> 1-conductor female plug; 4 mm<sup>2</sup>; 4-pole; 4,00 mm<sup>2</sup>; green-yellow, gray</p>	<a href="http://www.wago.com/769-104/000-037">www.wago.com/769-104/000-037</a>
	<p><b>Item no.: 769-104/000-038</b> 1-conductor female plug; 4 mm<sup>2</sup>; 4-pole; 4,00 mm<sup>2</sup>; gray, blue, green-yellow</p>	<a href="http://www.wago.com/769-104/000-038">www.wago.com/769-104/000-038</a>
	<p><b>Item no.: 769-104/000-039</b> 1-conductor female plug; 4 mm<sup>2</sup>; 4-pole; 4,00 mm<sup>2</sup>; green-yellow, blue, gray</p>	<a href="http://www.wago.com/769-104/000-039">www.wago.com/769-104/000-039</a>
	<p><b>Item no.: 769-104/022-000</b> 1-conductor female plug; angled; 4 mm<sup>2</sup>; 4-pole; 4,00 mm<sup>2</sup>; gray</p>	<a href="http://www.wago.com/769-104/022-000">www.wago.com/769-104/022-000</a>
	<p><b>Item no.: 769-105</b> 1-conductor female plug; 4 mm<sup>2</sup>; 5-pole; 4,00 mm<sup>2</sup>; gray</p>	<a href="http://www.wago.com/769-105">www.wago.com/769-105</a>
	<p><b>Item no.: 769-105/000-006</b> 1-conductor female plug; 4 mm<sup>2</sup>; 5-pole; 4,00 mm<sup>2</sup>; blue</p>	<a href="http://www.wago.com/769-105/000-006">www.wago.com/769-105/000-006</a>
	<p><b>Item no.: 769-105/000-036</b> 1-conductor female plug; 4 mm<sup>2</sup>; 5-pole; 4,00 mm<sup>2</sup>; gray, green-yellow</p>	<a href="http://www.wago.com/769-105/000-036">www.wago.com/769-105/000-036</a>
	<p><b>Item no.: 769-105/000-037</b> 1-conductor female plug; 4 mm<sup>2</sup>; 5-pole; 4,00 mm<sup>2</sup>; green-yellow, gray</p>	<a href="http://www.wago.com/769-105/000-037">www.wago.com/769-105/000-037</a>
	<p><b>Item no.: 769-105/000-038</b> 1-conductor female plug; 4 mm<sup>2</sup>; 5-pole; 4,00 mm<sup>2</sup>; gray, blue, green-yellow</p>	<a href="http://www.wago.com/769-105/000-038">www.wago.com/769-105/000-038</a>
	<p><b>Item no.: 769-105/000-039</b> 1-conductor female plug; 4 mm<sup>2</sup>; 5-pole; 4,00 mm<sup>2</sup>; green-yellow, blue, gray</p>	<a href="http://www.wago.com/769-105/000-039">www.wago.com/769-105/000-039</a>
	<p><b>Item no.: 769-105/022-000</b> 1-conductor female plug; angled; 4 mm<sup>2</sup>; 5-pole; 4,00 mm<sup>2</sup>; gray</p>	<a href="http://www.wago.com/769-105/022-000">www.wago.com/769-105/022-000</a>
	<p><b>Item no.: 769-106</b> 1-conductor female plug; 4 mm<sup>2</sup>; 6-pole; 4,00 mm<sup>2</sup>; gray</p>	<a href="http://www.wago.com/769-106">www.wago.com/769-106</a>

Subject to changes. Please also observe the further product documentation!





**Item no.: 769-106/000-006**  
1-conductor female plug; 4 mm<sup>2</sup>; 6-pole; 4,00 mm<sup>2</sup>; blue

[www.wago.com/769-106/000-006](http://www.wago.com/769-106/000-006)



**Item no.: 769-106/000-036**  
1-conductor female plug; 4 mm<sup>2</sup>; 6-pole; 4,00 mm<sup>2</sup>; gray, green-yellow

[www.wago.com/769-106/000-036](http://www.wago.com/769-106/000-036)

**Item no.: 769-106/000-037**  
1-conductor female plug; 4 mm<sup>2</sup>; 6-pole; 4,00 mm<sup>2</sup>; green-yellow, gray

[www.wago.com/769-106/000-037](http://www.wago.com/769-106/000-037)

**Item no.: 769-106/000-038**  
1-conductor female plug; 4 mm<sup>2</sup>; 6-pole; 4,00 mm<sup>2</sup>; gray, blue, green-yellow

[www.wago.com/769-106/000-038](http://www.wago.com/769-106/000-038)

**Item no.: 769-106/000-039**  
1-conductor female plug; 4 mm<sup>2</sup>; 6-pole; 4,00 mm<sup>2</sup>; green-yellow, blue, gray

[www.wago.com/769-106/000-039](http://www.wago.com/769-106/000-039)



**Item no.: 769-106/022-000**  
1-conductor female plug; angled; 4 mm<sup>2</sup>; 6-pole; 4,00 mm<sup>2</sup>; gray

[www.wago.com/769-106/022-000](http://www.wago.com/769-106/022-000)



**Item no.: 769-107**  
1-conductor female plug; 4 mm<sup>2</sup>; 7-pole; 4,00 mm<sup>2</sup>; gray

[www.wago.com/769-107](http://www.wago.com/769-107)

**Item no.: 769-107/000-006**  
1-conductor female plug; 4 mm<sup>2</sup>; 7-pole; 4,00 mm<sup>2</sup>; blue

[www.wago.com/769-107/000-006](http://www.wago.com/769-107/000-006)



**Item no.: 769-107/000-036**  
1-conductor female plug; 4 mm<sup>2</sup>; 7-pole; 4,00 mm<sup>2</sup>; gray, green-yellow

[www.wago.com/769-107/000-036](http://www.wago.com/769-107/000-036)



**Item no.: 769-107/000-037**  
1-conductor female plug; 4 mm<sup>2</sup>; 7-pole; 4,00 mm<sup>2</sup>; green-yellow, gray

[www.wago.com/769-107/000-037](http://www.wago.com/769-107/000-037)

**Item no.: 769-107/000-038**  
1-conductor female plug; 4 mm<sup>2</sup>; 7-pole; 4,00 mm<sup>2</sup>; gray, blue, green-yellow

[www.wago.com/769-107/000-038](http://www.wago.com/769-107/000-038)

**Item no.: 769-107/000-039**  
1-conductor female plug; 4 mm<sup>2</sup>; 7-pole; 4,00 mm<sup>2</sup>; green-yellow, blue, gray

[www.wago.com/769-107/000-039](http://www.wago.com/769-107/000-039)

**Item no.: 769-107/022-000**  
1-conductor female plug; angled; 4 mm<sup>2</sup>; 7-pole; 4,00 mm<sup>2</sup>; gray















[www.wago.com/769-107/022-000](http://www.wago.com/769-107/022-000)

















**Item no.: 769-108**  
1-conductor female plug; 4 mm<sup>2</sup>; 8-pole; 4,00 mm<sup>2</sup>; gray

[www.wago.com/769-108](http://www.wago.com/769-108)

Subject to changes. Please also observe the further product documentation!

	<p><b>Item no.: 769-108/000-006</b> 1-conductor female plug; 4 mm<sup>2</sup>; 8-pole; 4,00 mm<sup>2</sup>; blue</p>	<a href="http://www.wago.com/769-108/000-006">www.wago.com/769-108/000-006</a>
	<p><b>Item no.: 769-108/000-036</b> 1-conductor female plug; 4 mm<sup>2</sup>; 8-pole; 4,00 mm<sup>2</sup>; gray, green-yellow</p>	<a href="http://www.wago.com/769-108/000-036">www.wago.com/769-108/000-036</a>
	<p><b>Item no.: 769-108/000-037</b> 1-conductor female plug; 4 mm<sup>2</sup>; 8-pole; 4,00 mm<sup>2</sup>; green-yellow, gray</p>	<a href="http://www.wago.com/769-108/000-037">www.wago.com/769-108/000-037</a>
	<p><b>Item no.: 769-108/000-038</b> 1-conductor female plug; 4 mm<sup>2</sup>; 8-pole; 4,00 mm<sup>2</sup>; gray, blue, green-yellow</p>	<a href="http://www.wago.com/769-108/000-038">www.wago.com/769-108/000-038</a>
	<p><b>Item no.: 769-108/000-039</b> 1-conductor female plug; 4 mm<sup>2</sup>; 8-pole; 4,00 mm<sup>2</sup>; green-yellow, blue, gray</p>	<a href="http://www.wago.com/769-108/000-039">www.wago.com/769-108/000-039</a>
	<p><b>Item no.: 769-108/022-000</b> 1-conductor female plug; angled; 4 mm<sup>2</sup>; 8-pole; 4,00 mm<sup>2</sup>; gray</p>	<a href="http://www.wago.com/769-108/022-000">www.wago.com/769-108/022-000</a>
	<p><b>Item no.: 769-109</b> 1-conductor female plug; 4 mm<sup>2</sup>; 9-pole; 4,00 mm<sup>2</sup>; gray</p>	<a href="http://www.wago.com/769-109">www.wago.com/769-109</a>
	<p><b>Item no.: 769-109/000-006</b> 1-conductor female plug; 4 mm<sup>2</sup>; 9-pole; 4,00 mm<sup>2</sup>; blue</p>	<a href="http://www.wago.com/769-109/000-006">www.wago.com/769-109/000-006</a>
	<p><b>Item no.: 769-109/000-036</b> 1-conductor female plug; 4 mm<sup>2</sup>; 9-pole; 4,00 mm<sup>2</sup>; gray, green-yellow</p>	<a href="http://www.wago.com/769-109/000-036">www.wago.com/769-109/000-036</a>
	<p><b>Item no.: 769-109/000-037</b> 1-conductor female plug; 4 mm<sup>2</sup>; 9-pole; 4,00 mm<sup>2</sup>; green-yellow, gray</p>	<a href="http://www.wago.com/769-109/000-037">www.wago.com/769-109/000-037</a>
	<p><b>Item no.: 769-109/000-038</b> 1-conductor female plug; 4 mm<sup>2</sup>; 9-pole; 4,00 mm<sup>2</sup>; gray, blue, green-yellow</p>	<a href="http://www.wago.com/769-109/000-038">www.wago.com/769-109/000-038</a>
	<p><b>Item no.: 769-109/000-039</b> 1-conductor female plug; 4 mm<sup>2</sup>; 9-pole; 4,00 mm<sup>2</sup>; green-yellow, blue, gray</p>	<a href="http://www.wago.com/769-109/000-039">www.wago.com/769-109/000-039</a>
	<p><b>Item no.: 769-109/022-000</b> 1-conductor female plug; angled; 4 mm<sup>2</sup>; 9-pole; 4,00 mm<sup>2</sup>; gray</p>	<a href="http://www.wago.com/769-109/022-000">www.wago.com/769-109/022-000</a>
	<p><b>Item no.: 769-110</b> 1-conductor female plug; 4 mm<sup>2</sup>; 10-pole; 4,00 mm<sup>2</sup>; gray</p>	<a href="http://www.wago.com/769-110">www.wago.com/769-110</a>

Subject to changes. Please also observe the further product documentation!

	<p><b>Item no.: 769-110/000-006</b> 1-conductor female plug; 4 mm<sup>2</sup>; 10-pole; 4,00 mm<sup>2</sup>; blue</p>	<a href="http://www.wago.com/769-110/000-006">www.wago.com/769-110/000-006</a>
	<p><b>Item no.: 769-110/000-036</b> 1-conductor female plug; 4 mm<sup>2</sup>; 10-pole; 4,00 mm<sup>2</sup>; gray, green-yellow</p>	<a href="http://www.wago.com/769-110/000-036">www.wago.com/769-110/000-036</a>
	<p><b>Item no.: 769-110/000-037</b> 1-conductor female plug; 4 mm<sup>2</sup>; 10-pole; 4,00 mm<sup>2</sup>; green-yellow, gray</p>	<a href="http://www.wago.com/769-110/000-037">www.wago.com/769-110/000-037</a>
	<p><b>Item no.: 769-110/000-038</b> 1-conductor female plug; 4 mm<sup>2</sup>; 10-pole; 4,00 mm<sup>2</sup>; gray, blue, green-yellow</p>	<a href="http://www.wago.com/769-110/000-038">www.wago.com/769-110/000-038</a>
	<p><b>Item no.: 769-110/000-039</b> 1-conductor female plug; 4 mm<sup>2</sup>; 10-pole; 4,00 mm<sup>2</sup>; green-yellow, blue, gray</p>	<a href="http://www.wago.com/769-110/000-039">www.wago.com/769-110/000-039</a>
	<p><b>Item no.: 769-110/022-000</b> 1-conductor female plug; angled; 4 mm<sup>2</sup>; 10-pole; 4,00 mm<sup>2</sup>; gray</p>	<a href="http://www.wago.com/769-110/022-000">www.wago.com/769-110/022-000</a>
	<p><b>Item no.: 769-111</b> 1-conductor female plug; 4 mm<sup>2</sup>; 11-pole; 4,00 mm<sup>2</sup>; gray</p>	<a href="http://www.wago.com/769-111">www.wago.com/769-111</a>
	<p><b>Item no.: 769-111/000-006</b> 1-conductor female plug; 4 mm<sup>2</sup>; 11-pole; 4,00 mm<sup>2</sup>; blue</p>	<a href="http://www.wago.com/769-111/000-006">www.wago.com/769-111/000-006</a>
	<p><b>Item no.: 769-111/000-036</b> 1-conductor female plug; 4 mm<sup>2</sup>; 11-pole; 4,00 mm<sup>2</sup>; gray, green-yellow</p>	<a href="http://www.wago.com/769-111/000-036">www.wago.com/769-111/000-036</a>
	<p><b>Item no.: 769-111/000-037</b> 1-conductor female plug; 4 mm<sup>2</sup>; 11-pole; 4,00 mm<sup>2</sup>; green-yellow, gray</p>	<a href="http://www.wago.com/769-111/000-037">www.wago.com/769-111/000-037</a>
	<p><b>Item no.: 769-111/000-038</b> 1-conductor female plug; 4 mm<sup>2</sup>; 11-pole; 4,00 mm<sup>2</sup>; gray, blue, green-yellow</p>	<a href="http://www.wago.com/769-111/000-038">www.wago.com/769-111/000-038</a>
	<p><b>Item no.: 769-111/000-039</b> 1-conductor female plug; 4 mm<sup>2</sup>; 11-pole; 4,00 mm<sup>2</sup>; green-yellow, blue, gray</p>	<a href="http://www.wago.com/769-111/000-039">www.wago.com/769-111/000-039</a>
	<p><b>Item no.: 769-111/022-000</b> 1-conductor female plug; angled; 4 mm<sup>2</sup>; 11-pole; 4,00 mm<sup>2</sup>; gray</p>	<a href="http://www.wago.com/769-111/022-000">www.wago.com/769-111/022-000</a>
	<p><b>Item no.: 769-112</b> 1-conductor female plug; 4 mm<sup>2</sup>; 12-pole; 4,00 mm<sup>2</sup>; gray</p>	<a href="http://www.wago.com/769-112">www.wago.com/769-112</a>

Subject to changes. Please also observe the further product documentation!



**Item no.: 769-112/000-006**  
1-conductor female plug; 4 mm<sup>2</sup>; 12-pole; 4,00 mm<sup>2</sup>; blue

[www.wago.com/769-112/000-006](http://www.wago.com/769-112/000-006)



**Item no.: 769-112/000-036**  
1-conductor female plug; 4 mm<sup>2</sup>; 12-pole; 4,00 mm<sup>2</sup>; gray, green-yellow

[www.wago.com/769-112/000-036](http://www.wago.com/769-112/000-036)



**Item no.: 769-112/000-037**  
1-conductor female plug; 4 mm<sup>2</sup>; 12-pole; 4,00 mm<sup>2</sup>; green-yellow, gray

[www.wago.com/769-112/000-037](http://www.wago.com/769-112/000-037)



**Item no.: 769-112/000-038**  
1-conductor female plug; 4 mm<sup>2</sup>; 12-pole; 4,00 mm<sup>2</sup>; gray, blue, green-yellow

[www.wago.com/769-112/000-038](http://www.wago.com/769-112/000-038)



**Item no.: 769-112/000-039**  
1-conductor female plug; 4 mm<sup>2</sup>; 12-pole; 4,00 mm<sup>2</sup>; green-yellow, blue, gray

[www.wago.com/769-112/000-039](http://www.wago.com/769-112/000-039)



**Item no.: 769-112/022-000**  
1-conductor female plug; angled; 4 mm<sup>2</sup>; 12-pole; 4,00 mm<sup>2</sup>; gray

[www.wago.com/769-112/022-000](http://www.wago.com/769-112/022-000)



**Item no.: 769-113**  
1-conductor female plug; 4 mm<sup>2</sup>; 13-pole; 4,00 mm<sup>2</sup>; gray

[www.wago.com/769-113](http://www.wago.com/769-113)



**Item no.: 769-113/000-036**  
1-conductor female plug; 4 mm<sup>2</sup>; 13-pole; 4,00 mm<sup>2</sup>; gray, green-yellow

[www.wago.com/769-113/000-036](http://www.wago.com/769-113/000-036)



**Item no.: 769-113/000-037**  
1-conductor female plug; 4 mm<sup>2</sup>; 13-pole; 4,00 mm<sup>2</sup>; green-yellow, gray

[www.wago.com/769-113/000-037](http://www.wago.com/769-113/000-037)



**Item no.: 769-113/000-038**  
1-conductor female plug; 4 mm<sup>2</sup>; 13-pole; 4,00 mm<sup>2</sup>; gray, blue, green-yellow

[www.wago.com/769-113/000-038](http://www.wago.com/769-113/000-038)



**Item no.: 769-113/000-039**  
1-conductor female plug; 4 mm<sup>2</sup>; 13-pole; 4,00 mm<sup>2</sup>; green-yellow, blue, gray

[www.wago.com/769-113/000-039](http://www.wago.com/769-113/000-039)



**Item no.: 769-113/022-000**  
1-conductor female plug; angled; 4 mm<sup>2</sup>; 13-pole; 4,00 mm<sup>2</sup>; gray

[www.wago.com/769-113/022-000](http://www.wago.com/769-113/022-000)



**Item no.: 769-114**  
1-conductor female plug; 4 mm<sup>2</sup>; 14-pole; 4,00 mm<sup>2</sup>; gray

[www.wago.com/769-114](http://www.wago.com/769-114)



**Item no.: 769-114/000-006**  
1-conductor female plug; 4 mm<sup>2</sup>; 14-pole; 4,00 mm<sup>2</sup>; blue

[www.wago.com/769-114/000-006](http://www.wago.com/769-114/000-006)

Subject to changes. Please also observe the further product documentation!



**Item no.: 769-114/000-036**

1-conductor female plug; 4 mm<sup>2</sup>; 14-pole; 4,00 mm<sup>2</sup>; gray, green-yellow

[www.wago.com/769-114/000-036](http://www.wago.com/769-114/000-036)



**Item no.: 769-114/000-037**

1-conductor female plug; 4 mm<sup>2</sup>; 14-pole; 4,00 mm<sup>2</sup>; green-yellow, gray

[www.wago.com/769-114/000-037](http://www.wago.com/769-114/000-037)



**Item no.: 769-114/000-038**

1-conductor female plug; 4 mm<sup>2</sup>; 14-pole; 4,00 mm<sup>2</sup>; gray, blue, green-yellow

[www.wago.com/769-114/000-038](http://www.wago.com/769-114/000-038)



**Item no.: 769-114/000-039**

1-conductor female plug; 4 mm<sup>2</sup>; 14-pole; 4,00 mm<sup>2</sup>; green-yellow, blue, gray

[www.wago.com/769-114/000-039](http://www.wago.com/769-114/000-039)



**Item no.: 769-114/022-000**

1-conductor female plug; angled; 4 mm<sup>2</sup>; 14-pole; 4,00 mm<sup>2</sup>; gray

[www.wago.com/769-114/022-000](http://www.wago.com/769-114/022-000)



**Item no.: 769-115**

1-conductor female plug; 4 mm<sup>2</sup>; 15-pole; 4,00 mm<sup>2</sup>; gray

[www.wago.com/769-115](http://www.wago.com/769-115)



**Item no.: 769-115/000-036**

1-conductor female plug; 4 mm<sup>2</sup>; 15-pole; 4,00 mm<sup>2</sup>; gray, green-yellow

[www.wago.com/769-115/000-036](http://www.wago.com/769-115/000-036)



**Item no.: 769-115/000-037**

1-conductor female plug; 4 mm<sup>2</sup>; 15-pole; 4,00 mm<sup>2</sup>; green-yellow, gray

[www.wago.com/769-115/000-037](http://www.wago.com/769-115/000-037)



**Item no.: 769-115/000-038**

1-conductor female plug; 4 mm<sup>2</sup>; 15-pole; 4,00 mm<sup>2</sup>; gray, blue, green-yellow

[www.wago.com/769-115/000-038](http://www.wago.com/769-115/000-038)



**Item no.: 769-115/000-039**

1-conductor female plug; 4 mm<sup>2</sup>; 15-pole; 4,00 mm<sup>2</sup>; green-yellow, blue, gray

[www.wago.com/769-115/000-039](http://www.wago.com/769-115/000-039)



**Item no.: 769-115/022-000**

1-conductor female plug; angled; 4 mm<sup>2</sup>; 15-pole; 4,00 mm<sup>2</sup>; gray

[www.wago.com/769-115/022-000](http://www.wago.com/769-115/022-000)

#### End plate



**Item no.: 769-311**

End and intermediate plate; 1.1 mm thick; gray

[www.wago.com/769-311](http://www.wago.com/769-311)



**Item no.: 769-312**

End and intermediate plate; 1.1 mm thick; orange

[www.wago.com/769-312](http://www.wago.com/769-312)



**Item no.: 769-314**

Separator plate; 1.1 mm thick; oversized; orange

[www.wago.com/769-314](http://www.wago.com/769-314)

Subject to changes. Please also observe the further product documentation!

WAGO Kontakttechnik GmbH & Co. KG

Hansastr. 27

32423 Minden









Phone: +49571 887-0 | Fax: +49571 887-169

Email: [info.de@wago.com](mailto:info.de@wago.com) | Web: [www.wago.com](http://www.wago.com)











Do you have any questions about our products?

We are always happy to take your call at +49 (571) 887-44222.

## Marking accessories

	<b>Item no.: 2009-145</b> Mini-WSB Inline; for Smart Printer; 1700 pieces on roll; stretchable 5 - 5.2 mm; plain; snap-on type; white	<a href="http://www.wago.com/2009-145">www.wago.com/2009-145</a>
	<b>Item no.: 2009-145/000-002</b> Mini-WSB Inline; for Smart Printer; 1700 pieces on roll; stretchable 5 - 5.2 mm; plain; snap-on type; white	<a href="http://www.wago.com/2009-145/000-002">www.wago.com/2009-145/000-002</a>
	<b>Item no.: 2009-145/000-005</b> Mini-WSB Inline; for Smart Printer; 1700 pieces on roll; stretchable 5 - 5.2 mm; plain; snap-on type; red	<a href="http://www.wago.com/2009-145/000-005">www.wago.com/2009-145/000-005</a>
	<b>Item no.: 2009-145/000-006</b> Mini-WSB Inline; for Smart Printer; 1700 pieces on roll; stretchable 5 - 5.2 mm; plain; snap-on type; blue	<a href="http://www.wago.com/2009-145/000-006">www.wago.com/2009-145/000-006</a>
	<b>Item no.: 2009-145/000-007</b> Mini-WSB Inline; for Smart Printer; 1700 pieces on roll; stretchable 5 - 5.2 mm; plain; snap-on type; white	<a href="http://www.wago.com/2009-145/000-007">www.wago.com/2009-145/000-007</a>
	<b>Item no.: 2009-145/000-012</b> Mini-WSB Inline; for Smart Printer; 1700 pieces on roll; stretchable 5 - 5.2 mm; plain; snap-on type; orange	<a href="http://www.wago.com/2009-145/000-012">www.wago.com/2009-145/000-012</a>
	<b>Item no.: 2009-145/000-023</b> Mini-WSB Inline; for Smart Printer; 1700 pieces on roll; stretchable 5 - 5.2 mm; plain; snap-on type; green	<a href="http://www.wago.com/2009-145/000-023">www.wago.com/2009-145/000-023</a>
	<b>Item no.: 2009-145/000-024</b> Mini-WSB Inline; for Smart Printer; 1700 pieces on roll; stretchable 5 - 5.2 mm; plain; snap-on type; violet	<a href="http://www.wago.com/2009-145/000-024">www.wago.com/2009-145/000-024</a>
	<b>Item no.: 248-501</b> Miniature WSB Quick marking system; plain; Marker width 5 mm; 10 strips with 10 markers per card	<a href="http://www.wago.com/248-501">www.wago.com/248-501</a>
	<b>Item no.: 248-501/000-002</b> Mini-WSB marking card; as card; not stretchable; plain; snap-on type; yellow	<a href="http://www.wago.com/248-501/000-002">www.wago.com/248-501/000-002</a>
	<b>Item no.: 248-501/000-005</b> Mini-WSB marking card; as card; not stretchable; plain; snap-on type; red	<a href="http://www.wago.com/248-501/000-005">www.wago.com/248-501/000-005</a>
	<b>Item no.: 248-501/000-006</b> Mini-WSB marking card; as card; not stretchable; plain; snap-on type; blue	<a href="http://www.wago.com/248-501/000-006">www.wago.com/248-501/000-006</a>
	<b>Item no.: 248-501/000-007</b> Mini-WSB marking card; as card; not stretchable; plain; snap-on type; gray	<a href="http://www.wago.com/248-501/000-007">www.wago.com/248-501/000-007</a>

Subject to changes. Please also observe the further product documentation!









	<p><b>Item no.: 248-501/000-012</b> Mini-WSB marking card; as card; not stretchable; plain; snap-on type; orange</p>	<p><a href="http://www.wago.com/248-501/000-012">www.wago.com/248-501/000-012</a></p>
	<p><b>Item no.: 248-501/000-017</b> Mini-WSB marking card; as card; not stretchable; plain; snap-on type; light green</p>	<p><a href="http://www.wago.com/248-501/000-017">www.wago.com/248-501/000-017</a></p>
	<p><b>Item no.: 248-501/000-023</b> Mini-WSB marking card; as card; not stretchable; plain; snap-on type; green</p>	<p><a href="http://www.wago.com/248-501/000-023">www.wago.com/248-501/000-023</a></p>
	<p><b>Item no.: 248-501/000-024</b> Mini-WSB marking card; as card; not stretchable; plain; snap-on type; violet</p>	<p><a href="http://www.wago.com/248-501/000-024">www.wago.com/248-501/000-024</a></p>
<b>plug</b>		
	<p><b>Item no.: 280-801</b> Empty component plug housing; gray</p>	<p><a href="http://www.wago.com/280-801">www.wago.com/280-801</a></p>
	<p><b>Item no.: 280-801/281-411</b> Component plug; for carrier terminal blocks; 2-pole; with diode 1N4007; 5 mm wide; gray</p>	<p><a href="http://www.wago.com/280-801/281-411">www.wago.com/280-801/281-411</a></p>
	<p><b>Item no.: 280-801/281-413</b> Component plug; for carrier terminal blocks; 1-pole; LED (red); 24 VDC; 5 mm wide; gray</p>	<p><a href="http://www.wago.com/280-801/281-413">www.wago.com/280-801/281-413</a></p>
	<p><b>Item no.: 280-801/281-414</b> Component plug; for carrier terminal blocks; 1-pole; LED (red); 48 VDC; 5 mm wide; gray</p>	<p><a href="http://www.wago.com/280-801/281-414">www.wago.com/280-801/281-414</a></p>
	<p><b>Item no.: 280-801/281-415</b> Component plug; for carrier terminal blocks; 1-pole; LED (red); 5 mm wide; gray</p>	<p><a href="http://www.wago.com/280-801/281-415">www.wago.com/280-801/281-415</a></p>
	<p><b>Item no.: 280-801/281-416</b> Component plug; for carrier terminal blocks; 1-pole; LED (red); 5 mm wide; gray</p>	<p><a href="http://www.wago.com/280-801/281-416">www.wago.com/280-801/281-416</a></p>
	<p><b>Item no.: 280-801/281-417</b> Component plug; for carrier terminal blocks; 1-pole; 5 mm wide; gray</p>	<p><a href="http://www.wago.com/280-801/281-417">www.wago.com/280-801/281-417</a></p>
	<p><b>Item no.: 280-801/281-418</b> Component plug; for carrier terminal blocks; 1-pole; 5 mm wide; gray</p>	<p><a href="http://www.wago.com/280-801/281-418">www.wago.com/280-801/281-418</a></p>
	<p><b>Item no.: 280-801/281-420</b> Component plug; for carrier terminal blocks; 2-pole; with LED and recovery diode; 5 mm wide; gray</p>	<p><a href="http://www.wago.com/280-801/281-420">www.wago.com/280-801/281-420</a></p>

Subject to changes. Please also observe the further product documentation!





	<b>Item no.: 280-801/281-421</b> Component plug; for carrier terminal blocks; 2-pole; with LED and recovery diode; 5 mm wide; gray	<a href="http://www.wago.com/280-801/281-421">www.wago.com/280-801/281-421</a>
	<b>Item no.: 280-850</b> Fuse plug; with soldered miniature fuse; 250 mA FF; 5 mm wide; gray	<a href="http://www.wago.com/280-850">www.wago.com/280-850</a>
	<b>Item no.: 280-850/281-413</b> Fuse plug; with soldered miniature fuse; with indicator lamp; LED (red); DC 15 - 30 V; 250 mA FF; 5 mm wide; gray	<a href="http://www.wago.com/280-850/281-413">www.wago.com/280-850/281-413</a>
	<b>Item no.: 280-850/281-414</b> Fuse plug; with soldered miniature fuse; with indicator lamp; LED (red); DC 30 - 65 V; 250 mA FF; 5 mm wide; gray	<a href="http://www.wago.com/280-850/281-414">www.wago.com/280-850/281-414</a>
	<b>Item no.: 280-850/281-415</b> Fuse plug; with soldered miniature fuse; with indicator lamp; LED (red); AC 15 - 30 V; 250 mA FF; 5 mm wide; gray	<a href="http://www.wago.com/280-850/281-415">www.wago.com/280-850/281-415</a>
	<b>Item no.: 280-852</b> Fuse plug; with soldered miniature fuse; 500 mA FF; 5 mm wide; gray	<a href="http://www.wago.com/280-852">www.wago.com/280-852</a>
	<b>Item no.: 280-852/281-413</b> Fuse plug; with soldered miniature fuse; with indicator lamp; LED (red); DC 15 - 30 V; 500 mA FF; 5 mm wide; gray	<a href="http://www.wago.com/280-852/281-413">www.wago.com/280-852/281-413</a>
	<b>Item no.: 280-852/281-414</b> Fuse plug; with soldered miniature fuse; with indicator lamp; LED (red); DC 30 - 65 V; 500 mA FF; 5 mm wide; gray	<a href="http://www.wago.com/280-852/281-414">www.wago.com/280-852/281-414</a>
	<b>Item no.: 280-852/281-415</b> Fuse plug; with soldered miniature fuse; with indicator lamp; LED (red); AC 15 - 30 V; 500 mA FF; 5 mm wide; gray	<a href="http://www.wago.com/280-852/281-415">www.wago.com/280-852/281-415</a>
	<b>Item no.: 280-854</b> Fuse plug; with soldered miniature fuse; 1 A FF; 5 mm wide; gray	<a href="http://www.wago.com/280-854">www.wago.com/280-854</a>
	<b>Item no.: 280-854/281-413</b> Fuse plug; with soldered miniature fuse; with indicator lamp; LED (red); DC 15 - 30 V; 1 A FF; 5 mm wide; gray	<a href="http://www.wago.com/280-854/281-413">www.wago.com/280-854/281-413</a>
	<b>Item no.: 280-854/281-414</b> Fuse plug; with soldered miniature fuse; with indicator lamp; LED (red); DC 30 - 65 V; 1 A FF; 5 mm wide; gray	<a href="http://www.wago.com/280-854/281-414">www.wago.com/280-854/281-414</a>
	<b>Item no.: 280-854/281-415</b> Fuse plug; with soldered miniature fuse; with indicator lamp; LED (red); AC 15 - 30 V; 1 A FF; 5 mm wide; gray	<a href="http://www.wago.com/280-854/281-415">www.wago.com/280-854/281-415</a>
	<b>Item no.: 280-856</b> Fuse plug; with soldered miniature fuse; 2 A FF; 5 mm wide; gray	<a href="http://www.wago.com/280-856">www.wago.com/280-856</a>
	<b>Item no.: 280-856/281-413</b> Fuse plug; with soldered miniature fuse; with indicator lamp; LED (red); DC 15 - 30 V; 2 A FF; 5 mm	

Subject to changes. Please also observe the further product documentation!















	wide; gray	<a href="http://www.wago.com/280-856/281-413">www.wago.com/280-856/281-413</a>
	<b>Item no.: 280-856/281-414</b> Fuse plug; with soldered miniature fuse; with indicator lamp; LED (red); DC 30 - 65 V; 2 A FF; 5 mm wide; gray	<a href="http://www.wago.com/280-856/281-414">www.wago.com/280-856/281-414</a>
	<b>Item no.: 280-856/281-415</b> Fuse plug; with soldered miniature fuse; with indicator lamp; LED (red); AC 15 - 30 V; 2 A FF; 5 mm wide; gray	<a href="http://www.wago.com/280-856/281-415">www.wago.com/280-856/281-415</a>
	<b>Item no.: 281-511</b> Fuse plug; with pull-tab; for miniature metric fuses 5 x 20 mm and 5 x 25 mm; without blown fuse indication; 6 mm wide; gray	<a href="http://www.wago.com/281-511">www.wago.com/281-511</a>
	<b>Item no.: 281-512</b> Fuse plug; with pull-tab; for miniature metric fuses 5 x 20 mm and 5 x 25 mm; with port for LED; 6 mm wide; gray	<a href="http://www.wago.com/281-512">www.wago.com/281-512</a>
	<b>Item no.: 281-512/281-417</b> Fuse plug; with pull-tab; for miniature metric fuses 5 x 20 mm and 5 x 25 mm; with blown fuse indication by neon lamp; 230 V; 6 mm wide; gray	<a href="http://www.wago.com/281-512/281-417">www.wago.com/281-512/281-417</a>
	<b>Item no.: 281-512/281-418</b> Fuse plug; with pull-tab; for miniature metric fuses 5 x 20 mm and 5 x 25 mm; with blown fuse indication by neon lamp; 120 V; 6 mm wide; gray	<a href="http://www.wago.com/281-512/281-418">www.wago.com/281-512/281-418</a>
	<b>Item no.: 281-512/281-501</b> Fuse plug; with pull-tab; for miniature metric fuses 5 x 20 mm and 5 x 25 mm; with LED indicator; 24 V AC/DC; 6 mm wide; gray	<a href="http://www.wago.com/281-512/281-501">www.wago.com/281-512/281-501</a>

**General accessories**

	<b>Item no.: 280-802</b> Empty component plug housing; gray	<a href="http://www.wago.com/280-802">www.wago.com/280-802</a>
	<b>Item no.: 280-804</b> Empty component plug housing; 10 mm wide; Type 3; 4-pole; gray	<a href="http://www.wago.com/280-804">www.wago.com/280-804</a>
	<b>Item no.: 286-110</b> Empty component plug housing; Type 9; 10 mm wide; 4-pole; gray	<a href="http://www.wago.com/286-110">www.wago.com/286-110</a>
	<b>Item no.: 286-111</b> Empty component plug housing; Type 10; 15 mm wide; 6-pole; gray	<a href="http://www.wago.com/286-111">www.wago.com/286-111</a>
	<b>Item no.: 286-112</b> Empty component plug housing; Type 11; 20 mm wide; 8-pole; gray	<a href="http://www.wago.com/286-112">www.wago.com/286-112</a>
	<b>Item no.: 286-113</b> Empty component plug housing; Type 12; 25 mm wide; 10-pole; gray	<a href="http://www.wago.com/286-113">www.wago.com/286-113</a>
	<b>Item no.: 286-304</b> Relay module; Nominal input voltage: 24 VDC; 1 changeover contact; Limiting continuous current: 7 A; Red status indicator; Module width: 15 mm; gray	<a href="http://www.wago.com/286-304">www.wago.com/286-304</a>

Subject to changes. Please also observe the further product documentation!

	<p><b>Item no.: 286-304/004-000</b>                      Relay module; Nominal input voltage: 24 VDC; 1 changeover contact; Limiting continuous current: 7 A; Path; Red status indicator; Module width: 15 mm; gray</p>	<a href="http://www.wago.com/286-304/004-000">www.wago.com/286-304/004-000</a>
	<p><b>Item no.: 286-307/004-000</b>                      Relay module; Nominal input voltage: 110 VDC; 1 changeover contact; Limiting continuous current: 7 A; Path; Red status indicator; Module width: 15 mm; gray</p>	<a href="http://www.wago.com/286-307/004-000">www.wago.com/286-307/004-000</a>
	<p><b>Item no.: 286-312</b>                      Relay module; Relay with 2 changeover contacts (2u); gray</p>	<a href="http://www.wago.com/286-312">www.wago.com/286-312</a>
	<p><b>Item no.: 286-312/004-000</b>                      Relay module; Nominal input voltage: 24 VDC; 2 changeover contacts; Limiting continuous current: 5 A; Path; Red status indicator; Module width: 20 mm; gray</p>	<a href="http://www.wago.com/286-312/004-000">www.wago.com/286-312/004-000</a>
	<p><b>Item no.: 286-316</b>                      Relay module; Nominal input voltage: 220 VDC; 2 changeover contacts; Limiting continuous current: 7 A; Red status indicator; Module width: 20 mm; gray</p>	<a href="http://www.wago.com/286-316">www.wago.com/286-316</a>
	<p><b>Item no.: 286-320</b>                      Relay module; Nominal input voltage: 24 VDC; 1 break and 1 make contact; Limiting continuous current: 6 A; Red status indicator; Module width: 20 mm; gray</p>	<a href="http://www.wago.com/286-320">www.wago.com/286-320</a>
	<p><b>Item no.: 286-320/004-000</b>                      Relay module; Nominal input voltage: 24 VDC; 1 break and 1 make contact; Path; Red status indicator; Module width: 20 mm; gray</p>	<a href="http://www.wago.com/286-320/004-000">www.wago.com/286-320/004-000</a>
	<p><b>Item no.: 286-328</b>                      Relay module; Nominal input voltage: 24 VDC; 2 make contact; Limiting continuous current: 6 A; Red status indicator; Module width: 20 mm; gray</p>	<a href="http://www.wago.com/286-328">www.wago.com/286-328</a>
	<p><b>Item no.: 286-328/004-000</b>                      Relay module; Nominal input voltage: 24 VDC; 2 make contact; Limiting continuous current: 6 A; Path; Red status indicator; Module width: 20 mm; gray</p>	<a href="http://www.wago.com/286-328/004-000">www.wago.com/286-328/004-000</a>
	<p><b>Item no.: 286-336/001-000</b>                      Relay module; Nominal input voltage: 24 VDC; 2 break and 2 make contacts; Red status indicator; Module width: 25 mm; gray</p>	<a href="http://www.wago.com/286-336/001-000">www.wago.com/286-336/001-000</a>
	<p><b>Item no.: 286-344/004-000</b>                      Relay module; Nominal input voltage: 24 VDC; 3 break contacts and 1 make contact; Path; Red status indicator; Module width: 25 mm; gray</p>	<a href="http://www.wago.com/286-344/004-000">www.wago.com/286-344/004-000</a>
	<p><b>Item no.: 286-352/004-000</b>                      Relay module; Nominal input voltage: 24 VDC; 4 make contacts; Limiting continuous current: 5 A; Path; Red status indicator; Module width: 25 mm; gray</p>	<a href="http://www.wago.com/286-352/004-000">www.wago.com/286-352/004-000</a>
	<p><b>Item no.: 286-364</b>                      Relay module; Nominal input voltage: 24 VDC; 1 make contact; Limiting continuous current: 5 A; Red status indicator; Module width: 10 mm; gray</p>	<a href="http://www.wago.com/286-364">www.wago.com/286-364</a>
	<p><b>Item no.: 286-364/004-000</b>                      Relay module; Nominal input voltage: 24 VDC; 1 make contact; Path; Red status indicator; Module width: 10 mm; gray</p>	<a href="http://www.wago.com/286-364/004-000">www.wago.com/286-364/004-000</a>
	<p><b>Item no.: 286-368</b></p>	

Subject to changes. Please also observe the further product documentation!

Relay module; Nominal input voltage: 24 VDC; 1 break contact; Limiting continuous current: 5 A; Red status indicator; Module width: 10 mm; gray [www.wago.com/286-368](http://www.wago.com/286-368)

**Item no.: 286-368/004-000**

Relay module; Nominal input voltage: 24 VDC; 1 break contact; Path; Red status indicator; Module width: 10 mm

[www.wago.com/286-368/004-000](http://www.wago.com/286-368/004-000)

**Item no.: 286-376**

Relay module; Nominal input voltage: 24 VDC; 1 make contact; Limiting continuous current: 5 A; for switching higher DC loads; Red status indicator; Module width: 15 mm; gray

[www.wago.com/286-376](http://www.wago.com/286-376)

**Item no.: 286-380**

Bistable relay module; Nominal input voltage: 24 VDC; 1 changeover contact; Limiting continuous current: 6 A; Red status indicator; Module width: 15 mm; gray

[www.wago.com/286-380](http://www.wago.com/286-380)

**Item no.: 286-381**

Bistable relay module; Nominal input voltage: 24 VDC; 1 changeover contact; Limiting continuous current: 6 A; Red status indicator; Module width: 15 mm; gray

[www.wago.com/286-381](http://www.wago.com/286-381)

**Item no.: 286-394/004-000**

Relay module; Nominal input voltage: 24 VDC; 1 changeover contact; Path; Red status indicator; Module width: 15 mm; light gray

[www.wago.com/286-394/004-000](http://www.wago.com/286-394/004-000)

**Item no.: 286-427**

Timer relay module; Nominal input voltage: 24 VDC; Limiting continuous current: 5 A; Pulse lengthening: 1 ... 10 s; Red status indicator; Module width: 20 mm; gray

[www.wago.com/286-427](http://www.wago.com/286-427)

**Item no.: 286-507**

Relay module; Nominal input voltage: 115 VAC; 1 changeover contact; Limiting continuous current: 7 A; Red status indicator; Module width: 15 mm; gray

[www.wago.com/286-507](http://www.wago.com/286-507)

**Item no.: 286-508**

Relay module; Nominal input voltage: 230 VAC; 1 changeover contact; Limiting continuous current: 7 A; Red status indicator; Module width: 15 mm; gray

[www.wago.com/286-508](http://www.wago.com/286-508)

**Item no.: 286-516**

Relay module; Nominal input voltage: 230 VAC; 2 changeover contacts; Limiting continuous current: 7 A; Red status indicator; Module width: 15 mm; gray

[www.wago.com/286-516](http://www.wago.com/286-516)

**Item no.: 286-573**

Latching relay module; Nominal input voltage: 24 VDC; 1 changeover contact; Limiting continuous current: 6 A; Red status indicator; Module width: 15 mm

[www.wago.com/286-573](http://www.wago.com/286-573)

**Item no.: 286-575**

Latching relay module; Nominal input voltage: 24 VDC; 1 changeover contact; Limiting continuous current: 3 A; Path; Red status indicator; Module width: 22 mm

[www.wago.com/286-575](http://www.wago.com/286-575)

**Item no.: 286-604/004-000**

Timer relay module; Nominal input voltage: 24 VDC; Limiting continuous current: 6 A; On-delay: 10 ... 100 s; Red status indicator; Module width: 20 mm; gray

[www.wago.com/286-604/004-000](http://www.wago.com/286-604/004-000)

**Item no.: 286-640**

Timer relay module; Nominal input voltage: 24 VDC; Limiting continuous current: 6 A; Path; Multifunction/Multitime; Yellow status indicator; Module width: 6 mm; gray

[www.wago.com/286-640](http://www.wago.com/286-640)

**Item no.: 286-640/004-000**

Multifunction timing relay module; Relay with 1 changeover contact (1u); 4 time ranges; for railway operations; 4 functions; gray

[www.wago.com/286-640/004-000](http://www.wago.com/286-640/004-000)

Subject to changes. Please also observe the further product documentation!

WAGO Kontakttechnik GmbH & Co. KG

Hansastr. 27















32423 Minden

Phone: +49571 887-0 | Fax: +49571 887-169

















Email: [info.de@wago.com](mailto:info.de@wago.com) | Web: [www.wago.com](http://www.wago.com)

Do you have any questions about our products?

We are always happy to take your call at +49 (571) 887-44222.

	<b>Item no.: 286-661</b> Current flow monitoring module; AC currents; adjustable; light gray	<a href="http://www.wago.com/286-661">www.wago.com/286-661</a>
	<b>Item no.: 286-662</b> Current flow monitoring module; DC currents; Monitoring range: 0.4 A – 3.5 A; 1 make contact; light gray	<a href="http://www.wago.com/286-662">www.wago.com/286-662</a>
	<b>Item no.: 286-664</b> Current flow monitoring module; AC currents; Monitoring range: 1 A – 10 A; 1 changeover contact; light gray	<a href="http://www.wago.com/286-664">www.wago.com/286-664</a>
	<b>Item no.: 286-665</b> Current flow monitoring module; AC currents; Monitoring range: 1 A – 10 A; 1 changeover contact; light gray	<a href="http://www.wago.com/286-665">www.wago.com/286-665</a>
	<b>Item no.: 286-721</b> Optocoupler module; Nominal input voltage: 24 VDC; Output voltage range: 15 ... 30 VDC; Limiting continuous current: 5 A; 3-wire connection/low-side switching; Red status indicator; Module width: 15 mm; gray	<a href="http://www.wago.com/286-721">www.wago.com/286-721</a>
	<b>Item no.: 286-723</b> Optocoupler module; Nominal input voltage: 24 VDC; Output voltage range: 15 ... 30 VDC; Limiting continuous current: 4 A; 3-wire connection/high-side switching; Red status indicator; Module width: 15 mm; gray	<a href="http://www.wago.com/286-723">www.wago.com/286-723</a>
	<b>Item no.: 286-725</b> Optocoupler module; Input AC/DC 10 V ... 30 V; Output DC 24 V / 1 mA ... 0.5 A; negative switching; gray	<a href="http://www.wago.com/286-725">www.wago.com/286-725</a>
	<b>Item no.: 286-742</b> S0 interface power supply; Input voltage: 230 VAC; S0 interface	<a href="http://www.wago.com/286-742">www.wago.com/286-742</a>
	<b>Item no.: 286-752</b> Optocoupler module; Nominal input voltage: 24 VDC; Output voltage range: 20 ... 30 VDC; Limiting continuous current: 0.5 A; 3-wire connection/high-side switching; Frequency: 25 kHz; Red status indicator; Module width: 15 mm; gray	<a href="http://www.wago.com/286-752">www.wago.com/286-752</a>
	<b>Item no.: 286-752/002-000</b> Optocoupler module; Red status indicator; gray	<a href="http://www.wago.com/286-752/002-000">www.wago.com/286-752/002-000</a>
	<b>Item no.: 286-790</b> Optocoupler module; gray	<a href="http://www.wago.com/286-790">www.wago.com/286-790</a>
	<b>Item no.: 286-791</b> Optocoupler module; Nominal input voltage: 24 VDC; Output voltage range: 20 ... 60 VDC; Limiting continuous current: 0.1 A; 2-wire connection; Frequency: 3 kHz; Red status indicator; Module width: 10 mm; gray	<a href="http://www.wago.com/286-791">www.wago.com/286-791</a>
	<b>Item no.: 286-792</b> Optocoupler module; Red status indicator; gray	<a href="http://www.wago.com/286-792">www.wago.com/286-792</a>
	<b>Item no.: 286-794</b> Optocoupler module; Nominal input voltage: 24 VDC; Output voltage range: 20 ... 60 VDC; Limiting continuous current: 0.1 A; 2-wire connection; Red status indicator; Module width: 10 mm; gray	<a href="http://www.wago.com/286-794">www.wago.com/286-794</a>
	<b>Item no.: 286-797</b> Optocoupler module; Red status indicator	<a href="http://www.wago.com/286-797">www.wago.com/286-797</a>

Subject to changes. Please also observe the further product documentation!

	<b>Item no.: 286-803</b> Component module with diode; gray	<a href="http://www.wago.com/286-803">www.wago.com/286-803</a>
	<b>Item no.: 286-805</b> Component module with diode; light gray	<a href="http://www.wago.com/286-805">www.wago.com/286-805</a>
	<b>Item no.: 286-807</b> Component module with diode; with 7 pcs; Diode 1N4007; with common anode; light gray	<a href="http://www.wago.com/286-807">www.wago.com/286-807</a>
	<b>Item no.: 286-809</b> Component module with diode; light gray	<a href="http://www.wago.com/286-809">www.wago.com/286-809</a>
	<b>Item no.: 286-822</b> Component module with LED; Red LED; with common cathode	<a href="http://www.wago.com/286-822">www.wago.com/286-822</a>
	<b>Item no.: 286-826</b> AND gate module with 6 inputs; light gray	<a href="http://www.wago.com/286-826">www.wago.com/286-826</a>
	<b>Item no.: 286-830</b> Bridge rectifier module; Input voltage: 24 VAC; with varistor protective circuit; gray	<a href="http://www.wago.com/286-830">www.wago.com/286-830</a>
	<b>Item no.: 286-831</b> Surge suppression module for signal technology; Nominal voltage: 24 VAC/DC; for 2 signal paths with common surge arrester; plugged on rail-mount terminal block, 15 mm wide; gray	<a href="http://www.wago.com/286-831">www.wago.com/286-831</a>
	<b>Item no.: 286-832</b> Surge suppression module for signal technology; Nominal voltage: 24 VAC/DC; for 2 signal paths with common surge arrester; pluggable on rail-mount terminal block, 20 mm wide; gray	<a href="http://www.wago.com/286-832">www.wago.com/286-832</a>
	<b>Item no.: 286-833</b> Surge suppression module for signal technology; Nominal voltage: 24 VDC; for 1 signal path; plugged on rail-mount terminal block, 15 mm wide; gray	<a href="http://www.wago.com/286-833">www.wago.com/286-833</a>
	<b>Item no.: 286-834</b> Surge suppression module for signal technology; Nominal voltage: 12 VDC; for 2 signal paths with common surge arrester; pluggable on rail-mount terminal block, 20 mm wide; gray	<a href="http://www.wago.com/286-834">www.wago.com/286-834</a>
	<b>Item no.: 286-834/024-000</b> Surge suppression module for signal technology; Nominal voltage: 24 VDC; for 2 signal paths with common surge arrester; pluggable on rail-mount terminal block, 15 mm wide; gray	<a href="http://www.wago.com/286-834/024-000">www.wago.com/286-834/024-000</a>
	<b>Item no.: 286-840</b> Bridge rectifier module; Input voltage: 250 VAC; with varistor protective circuit; gray	<a href="http://www.wago.com/286-840">www.wago.com/286-840</a>
	<b>Item no.: 286-841</b> Surge suppression module for signal technology; Nominal voltage: 220 VDC; for 2 signal paths with common surge arrester; pluggable on rail-mount terminal block, 25 mm wide; gray	<a href="http://www.wago.com/286-841">www.wago.com/286-841</a>
	<b>Item no.: 286-842</b> Surge suppression module for signal technology; Nominal voltage: 230 VAC; for 2 signal paths with common surge arrester; pluggable on rail-mount terminal block, 25 mm wide; gray	<a href="http://www.wago.com/286-842">www.wago.com/286-842</a>
	<b>Item no.: 286-843</b> Surge suppression module for signal technology; Nominal voltage: 115 VAC; for 2 signal paths with common surge arrester; pluggable on rail-mount terminal block, 25 mm wide; gray	<a href="http://www.wago.com/286-843">www.wago.com/286-843</a>
	<b>Item no.: 286-844</b> Surge suppression module for signal technology; for 2 signal paths with common surge arrester;	<a href="http://www.wago.com/286-844">www.wago.com/286-844</a>

Subject to changes. Please also observe the further product documentation!



pluggable on rail-mount terminal block, 25 mm wide; gray

**Item no.: 286-890**

Component module with fuse; for (5 x 20) mm microfuse; Nominal voltage: 24 VAC/DC; gray

[www.wago.com/286-890](http://www.wago.com/286-890)

**Item no.: 286-891**

Component module with fuse; for (5 x 20) mm microfuse; Nominal voltage: 230 VAC/DC; gray

[www.wago.com/286-891](http://www.wago.com/286-891)

**Item no.: 286-895**

Switching module; with changeover rocker switch; Switching voltage: 250 VAC; Switching current: 6 A; gray

[www.wago.com/286-895](http://www.wago.com/286-895)

**Item no.: 286-896**

Switching module; with momentary switch; Switching voltage: 250 VAC; Switching current: 6 A; gray

[www.wago.com/286-896](http://www.wago.com/286-896)

**Item no.: 769-438**

Pin cover; with marker slot for miniature WSB; gray

[www.wago.com/769-438](http://www.wago.com/769-438)

**Item no.: 769-439**

Pin cover; with marker slot for miniature WSB; orange

[www.wago.com/769-439](http://www.wago.com/769-439)

**Item no.: 769-501**

Start module for 1-conductor female connector; with integrated end plate; 4 mm<sup>2</sup>; 1-pole; 4,00 mm<sup>2</sup>; gray

[www.wago.com/769-501](http://www.wago.com/769-501)

**Item no.: 769-501/000-006**

Start module for 1-conductor female connector; 4 mm<sup>2</sup>; 1-pole; 4,00 mm<sup>2</sup>; blue

[www.wago.com/769-501/000-006](http://www.wago.com/769-501/000-006)

**Item no.: 769-501/000-016**

Start module for 1-conductor female connector; with integrated end plate; 4 mm<sup>2</sup>; 1-pole; 4,00 mm<sup>2</sup>; green-yellow

[www.wago.com/769-501/000-016](http://www.wago.com/769-501/000-016)

**Item no.: 769-502**

Center module for 1-conductor female connector; 4 mm<sup>2</sup>; 1-pole; 4,00 mm<sup>2</sup>; gray

[www.wago.com/769-502](http://www.wago.com/769-502)

**Item no.: 769-502/000-006**

Center module for 1-conductor female connector; 4 mm<sup>2</sup>; 1-pole; 4,00 mm<sup>2</sup>; blue

[www.wago.com/769-502/000-006](http://www.wago.com/769-502/000-006)

**Item no.: 769-502/000-016**

Center module for 1-conductor female connector; 4 mm<sup>2</sup>; 1-pole; 4,00 mm<sup>2</sup>; green-yellow

[www.wago.com/769-502/000-016](http://www.wago.com/769-502/000-016)

**Item no.: 769-503**

End module for 1-conductor female connector; 4 mm<sup>2</sup>; 1-pole; 4,00 mm<sup>2</sup>; gray

[www.wago.com/769-503](http://www.wago.com/769-503)

**Item no.: 769-503/000-006**

End module for 1-conductor female connector; 4 mm<sup>2</sup>; 1-pole; 4,00 mm<sup>2</sup>; blue

[www.wago.com/769-503/000-006](http://www.wago.com/769-503/000-006)

**Item no.: 769-503/000-016**

End module for 1-conductor female connector; 4 mm<sup>2</sup>; 1-pole; 4,00 mm<sup>2</sup>; green-yellow

[www.wago.com/769-503/000-016](http://www.wago.com/769-503/000-016)

Subject to changes. Please also observe the further product documentation!

WAGO Kontakttechnik GmbH & Co. KG

Hansastr. 27















32423 Minden

Phone: +49571 887-0 | Fax: +49571 887-169

Email: [info.de@wago.com](mailto:info.de@wago.com) | Web: [www.wago.com](http://www.wago.com)













Do you have any questions about our products?

We are always happy to take your call at +49 (571) 887-44222.

	<b>Item no.: 769-512</b> Start module for 1-conductor female connector; angled; 4 mm <sup>2</sup> ; 1-pole; 4,00 mm <sup>2</sup> ; gray	<a href="http://www.wago.com/769-512">www.wago.com/769-512</a>
	<b>Item no.: 769-512/000-006</b> Start module for 1-conductor female connector; angled; 4 mm <sup>2</sup> ; 1-pole; 4,00 mm <sup>2</sup> ; blue	<a href="http://www.wago.com/769-512/000-006">www.wago.com/769-512/000-006</a>
	<b>Item no.: 769-512/000-016</b> Start module for 1-conductor female connector; angled; 4 mm <sup>2</sup> ; 1-pole; 4,00 mm <sup>2</sup> ; green-yellow	<a href="http://www.wago.com/769-512/000-016">www.wago.com/769-512/000-016</a>
	<b>Item no.: 769-513</b> Center module for 1-conductor female connector; angled; 4 mm <sup>2</sup> ; 1-pole; 4,00 mm <sup>2</sup> ; gray	<a href="http://www.wago.com/769-513">www.wago.com/769-513</a>
	<b>Item no.: 769-513/000-006</b> Center module for 1-conductor female connector; angled; 4 mm <sup>2</sup> ; 1-pole; 4,00 mm <sup>2</sup> ; blue	<a href="http://www.wago.com/769-513/000-006">www.wago.com/769-513/000-006</a>
	<b>Item no.: 769-513/000-016</b> Center module for 1-conductor female connector; angled; 4 mm <sup>2</sup> ; 1-pole; 4,00 mm <sup>2</sup> ; green-yellow	<a href="http://www.wago.com/769-513/000-016">www.wago.com/769-513/000-016</a>
	<b>Item no.: 769-515</b> End module for 1-conductor female connector; angled; 4 mm <sup>2</sup> ; 1-pole; 4,00 mm <sup>2</sup> ; gray	<a href="http://www.wago.com/769-515">www.wago.com/769-515</a>
	<b>Item no.: 769-515/000-006</b> End module for 1-conductor female connector; angled; 4 mm <sup>2</sup> ; 1-pole; 4,00 mm <sup>2</sup> ; blue	<a href="http://www.wago.com/769-515/000-006">www.wago.com/769-515/000-006</a>
	<b>Item no.: 769-515/000-016</b> End module for 1-conductor female connector; angled; 4 mm <sup>2</sup> ; 1-pole; 4,00 mm <sup>2</sup> ; green-yellow	<a href="http://www.wago.com/769-515/000-016">www.wago.com/769-515/000-016</a>
	<b>Item no.: 786-101</b> Empty component plug housing; Type 14; 15 mm wide; 6-pole; gray	<a href="http://www.wago.com/786-101">www.wago.com/786-101</a>
	<b>Item no.: 786-102</b> Empty component plug housing; Type 15; 20 mm wide; 8-pole; gray	<a href="http://www.wago.com/786-102">www.wago.com/786-102</a>
	<b>Item no.: 786-103</b> Empty component plug housing; Type 16; 25 mm wide; 10-pole; gray	<a href="http://www.wago.com/786-103">www.wago.com/786-103</a>
<b>Insulation stop</b>		
	<b>Item no.: 769-470</b> Insulation stop; 0.08 - 0.2 mm <sup>2</sup> "s" (0.14 mm <sup>2</sup> "f-st"); 5 pieces/strip; white	<a href="http://www.wago.com/769-470">www.wago.com/769-470</a>
	<b>Item no.: 769-471</b> Insulation stop; 0.25 - 0.5 mm <sup>2</sup> ; 5 pieces/strip; light gray	<a href="http://www.wago.com/769-471">www.wago.com/769-471</a>
	<b>Item no.: 769-472</b> Insulation stop; 0.75 - 1 mm <sup>2</sup> ; 5 pieces/strip; dark gray	<a href="http://www.wago.com/769-472">www.wago.com/769-472</a>
<b>Jumper</b>		

Subject to changes. Please also observe the further product documentation!



	<b>Item no.: 249-123</b> Push-in type wire jumper; insulated; wire length 180 mm; Conductor cross section 0.75 mm <sup>2</sup>	<a href="http://www.wago.com/249-123">www.wago.com/249-123</a>
	<b>Item no.: 249-125</b> Push-in type wire jumper; insulated; wire length 60 mm; Conductor cross section 0.75 mm <sup>2</sup>	<a href="http://www.wago.com/249-125">www.wago.com/249-125</a>
	<b>Item no.: 249-126</b> Push-in type wire jumper; insulated; wire length 110 mm; Conductor cross section 0.75 mm <sup>2</sup>	<a href="http://www.wago.com/249-126">www.wago.com/249-126</a>
	<b>Item no.: 249-127</b> Push-in type wire jumper; insulated; wire length 250 mm; Conductor cross section 0.75 mm <sup>2</sup>	<a href="http://www.wago.com/249-127">www.wago.com/249-127</a>
	<b>Item no.: 280-402</b> Adjacent jumper; insulated; IN = IN terminal block; gray	<a href="http://www.wago.com/280-402">www.wago.com/280-402</a>
	<b>Item no.: 280-409</b> Alternate jumper; insulated; IN = IN terminal block; gray	<a href="http://www.wago.com/280-409">www.wago.com/280-409</a>
	<b>Item no.: 780-452</b> Staggered jumper; insulated; from 1 to 2; Spacing: 5 mm; suitable for 2-conductor female plugs; gray	<a href="http://www.wago.com/780-452">www.wago.com/780-452</a>
	<b>Item no.: 780-453</b> Staggered jumper; insulated; from 1 to 3; Spacing: 5 mm; suitable for 2-conductor female plugs; gray	<a href="http://www.wago.com/780-453">www.wago.com/780-453</a>
	<b>Item no.: 780-454</b> Staggered jumper; insulated; from 1 to 4; Spacing: 5 mm; suitable for 2-conductor female plugs; gray	<a href="http://www.wago.com/780-454">www.wago.com/780-454</a>
	<b>Item no.: 780-455</b> Staggered jumper; insulated; from 1 to 5; Spacing: 5 mm; suitable for 2-conductor female plugs; gray	<a href="http://www.wago.com/780-455">www.wago.com/780-455</a>
	<b>Item no.: 780-456</b> Staggered jumper; insulated; from 1 to 6; Spacing: 5 mm; suitable for 2-conductor female plugs; gray	<a href="http://www.wago.com/780-456">www.wago.com/780-456</a>
	<b>Item no.: 780-457</b> Staggered jumper; insulated; from 1 to 7; Spacing: 5 mm; suitable for 2-conductor female plugs; gray	<a href="http://www.wago.com/780-457">www.wago.com/780-457</a>
	<b>Item no.: 780-458</b> Staggered jumper; insulated; from 1 to 8; Spacing: 5 mm; suitable for 2-conductor female plugs; gray	<a href="http://www.wago.com/780-458">www.wago.com/780-458</a>
<b>assembling</b>		
	<b>Item no.: 209-106</b> Mounting carrier; for isolated mounting on DIN 35 rails; gray	<a href="http://www.wago.com/209-106">www.wago.com/209-106</a>

## Downloads

### Documentation

#### Additional Information

Technical explanations	Apr 3, 2019	pdf 2.1 MB	Download
------------------------	-------------	---------------	----------

Subject to changes. Please also observe the further product documentation!



## CAD/CAE-Data

### CAD data

2D/3D Models 769-181	URL	Download
----------------------	-----	----------

### CAE data

EPLAN Data Portal 769-181	URL	Download
---------------------------	-----	----------

WSCAD Universe 769-181	URL	Download
------------------------	-----	----------

## Installation Notes

### Assembly

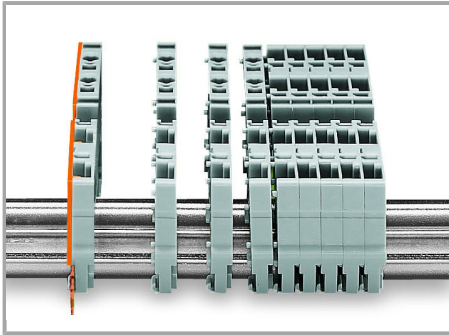

Snap individual carrier terminal blocks onto the carrier rail and slide together.

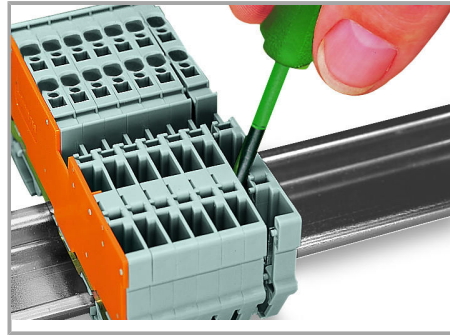

Open the assembly by laterally sliding a block via operating tool and remove terminal block via release lever.

### Inserting a conductor

Subject to changes. Please also observe the further product documentation!

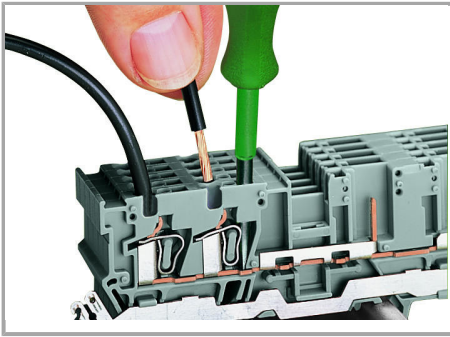

CAGE CLAMP® connection

Carrier terminal block: Insert/remove conductor via operating tool (3.5 x 0.5 mm blade).

#### Jumpered

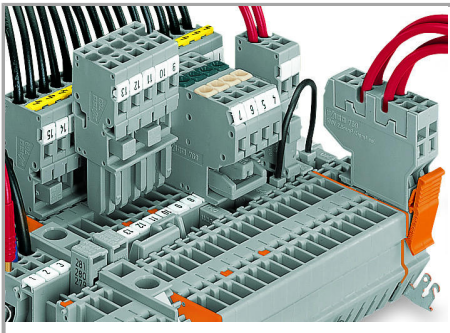

Commoning with adjacent or staggered jumpers –

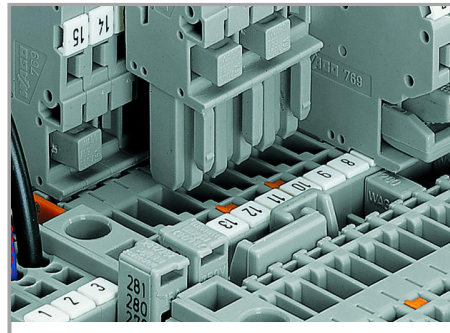

Commoning carrier terminal blocks via staggered jumpers.

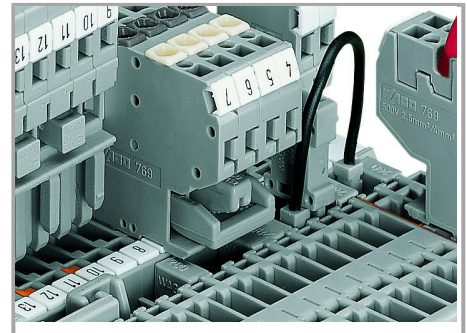

Commoning a 2-conductor female plug via staggered jumper and carrier terminal blocks via adjacent jumpers.

push jumpers down until fully inserted.

Subject to changes. Please also observe the further product documentation!

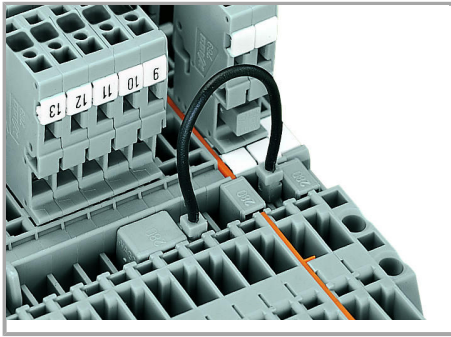

Commoning carrier terminal blocks via push-in type wire jumpers or adjacent jumpers – even over an intermediate plate.

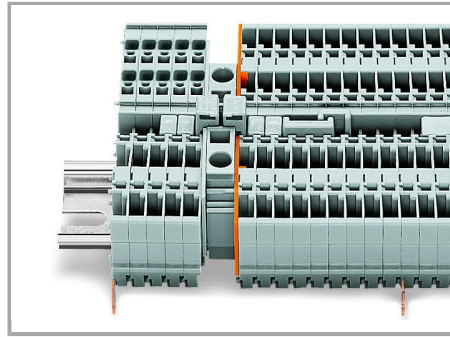

Commoning “supply terminal blocks” (up to 10 mm<sup>2</sup>/8 AWG) with carrier terminal blocks via step-down jumpers.

### Testing

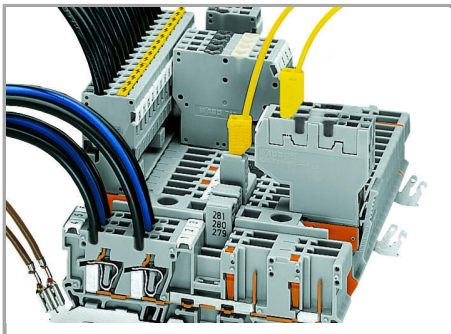

Testing via 2 or 2.3 mm Ø test plugs.

### Coding

Subject to changes. Please also observe the further product documentation!

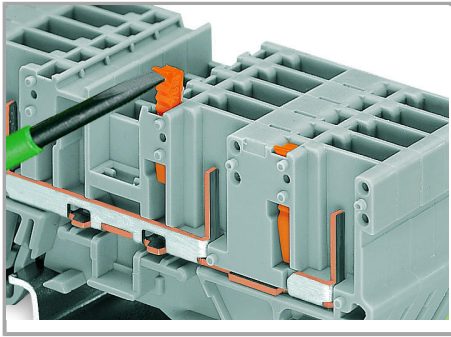

Snap coding pin in proper direction on carrier terminal block.

Shown: Coding pin removal from carrier terminal block.

#### Locking

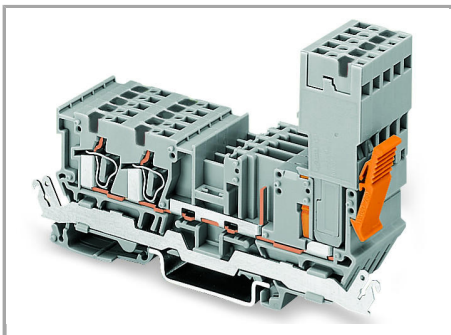

Female plug secured with locking lever on the terminal block side.

Subject to changes. Please also observe the further product documentation!

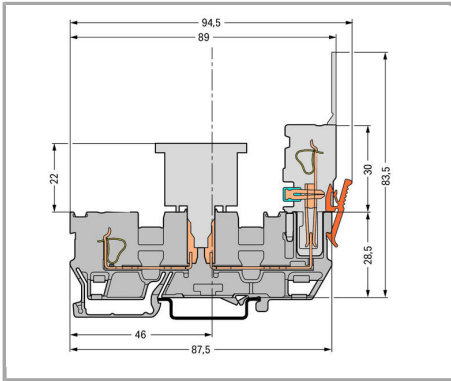

Carrier terminal block

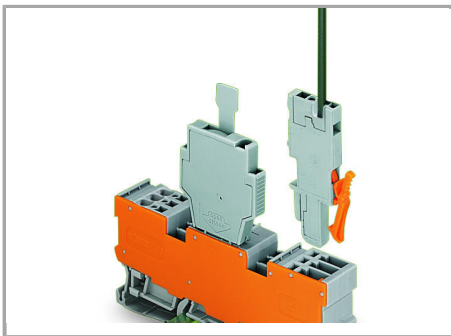

1-conductor/1-pin carrier terminal block  
with two jumper positions

1-conductor female plug, straight\*

Fuse plug, 6 mm wide (every other terminal  
block)

\*1-conductor angled female plug is also  
possible!

## Product family

### X-COM

[Learn more about the product family.](#)

[Show all products from the family](#)

Subject to changes. Please also observe the further product documentation!