

Data sheet | Item number: 769-176

1-conductor/1-pin carrier terminal block; for DIN-rail 35 x 15 and 35 x 7.5; 4 mm²; CAGE CLAMP®; 4,00 mm²; gray

www.wago.com/769-176

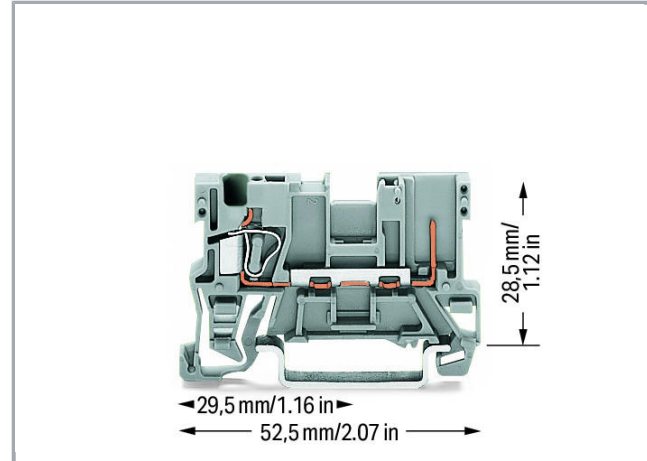
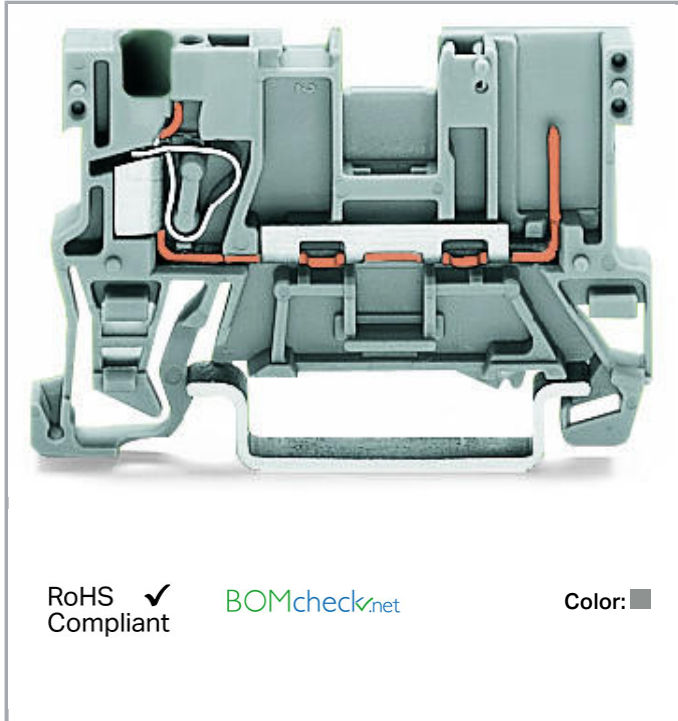

Subject to changes. Please also observe the further product documentation!

WAGO Kontakttechnik GmbH & Co. KG
Hansastr. 27
32423 Minden
Phone: +49571 887-0 | Fax: +49571 887-169
Email: info.de@wago.com | Web: www.wago.com

Do you have any questions about our products?
We are always happy to take your call at +49 (571) 887-44222.

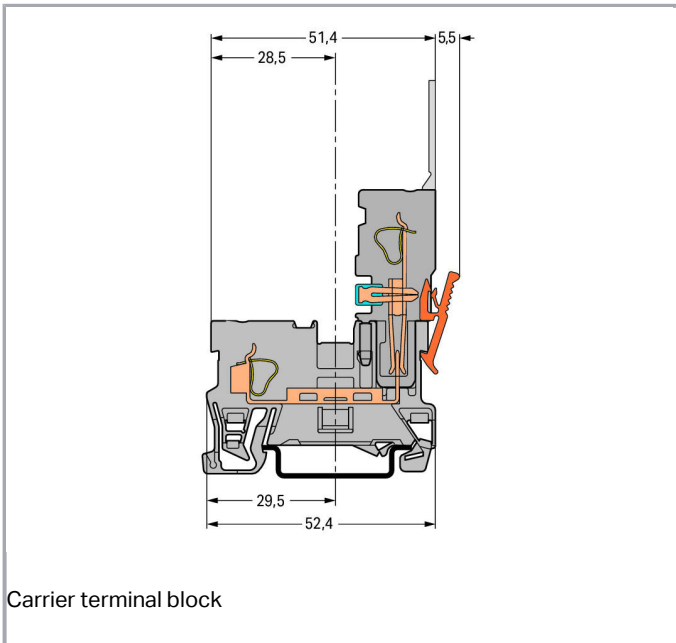

Data

Electrical data

Ratings per IEC/EN 60664-1

| Ratings per | IEC/EN 60947-7-1 |
|---------------------------------|-------------------------------------------------------------------|
| Rated voltage (III / 3) | 500 V |
| Rated impulse voltage (III / 3) | 6 kV |
| Rated current | 32 A |
| Legend (ratings) | (III / 3) $\hat{=}$ Overvoltage category III / Pollution degree 3 |

Connection data

| | |
|-----------------------------------|--------------------------------------------|
| Connection technology | CAGE CLAMP® |
| Actuation type | Open Tool Slot |
| Connectable conductor materials | Copper |
| Nominal cross section | 4 mm ² |
| Solid conductor | 0,08 ... 4 mm ² / 28 ... 12 AWG |
| Fine-stranded conductor | 0,08 ... 4 mm ² / 28 ... 12 AWG |
| Strip length | 8 ... 9 mm / 0.31 ... 0.35 inch |
| Total number of connection points | 1 |
| Total number of potentials | 1 |
| Number of levels | 1 |

Subject to changes. Please also observe the further product documentation!

WAGO Kontakttechnik GmbH & Co. KG
 Hansastr. 27
 32423 Minden
 Phone: +49571 887-0 | Fax: +49571 887-169
 Email: info.de@wago.com | Web: www.wago.com

Do you have any questions about our products?
 We are always happy to take your call at +49 (571) 887-44222.

| | |
|----------------|--------------------|
| Type of wiring | Front-entry wiring |
|----------------|--------------------|

Geometrical Data

| | |
|---------------------------------------|----------------------|
| Width | 5 mm / 0.197 inch |
| Height from upper-edge of DIN-35 rail | 28,5 mm / 1.122 inch |
| Depth | 52,5 mm / 2.067 inch |

Mechanical data

| | |
|------------------|-----------------|
| Design | horizontal type |
| Type of mounting | DIN-35 rail |
| Marking level | Center marking |

Material Data



| | |
|---------------------|----------------------|
| Color | gray |
| Insulating material | Polyamide 66 (PA 66) |
| Fire load | 0.101 MJ |
| Weight | 5.3 g |

Commercial data

| | |
|--------------------|-------------------|
| Product Group | 18 (X-COM-System) |
| Packaging type | BOX |
| Country of origin | CN |
| GTIN | 4045454871697 |
| Customs Tariff No. | 85366990990 |

Approvals / Certificates

Country specific Approvals



| Logo | Approval | Additional Approval Text | Certificate name |
|------------------------------------------------------------------------------------|---------------------------------|--------------------------|------------------|
|  | CCA DEKRA Certification B.V. | EN 60947 | NTR NL-7626 |
|  | CSA DEKRA Certification B.V. | C22.2 No. 158 | 1101144 |
| | KEMA/KEUR | EN 60947 | 2190419.01 |

Subject to changes. Please also observe the further product documentation!



DEKRA Certification B.V.



Ship Approvals

| Logo | Approval | Additional Approval Text | Certificate name |
|-----------------------------------------------------------------------------------|---------------------------------------------------------|--------------------------|--------------------------|
|  | ABS American Bureau of Shipping | EN 60947 | 20- HG1941090- PDA |
|  | DNV GL Det Norske Veritas, Germanischer Lloyd | - | TAE00001V2 |
|  | LR Lloyds Register | EN 60947 | 91/20112 (E9) |

UL-Approvals

| Logo | Approval | Additional Approval Text | Certificate name |
|------------------------------------------------------------------------------------|---------------------------------------------|--------------------------|---------------------|
|  | UR Underwriters Laboratories Inc. | UL 1059 | 20190731- E45172 |
|  | UR Underwriters Laboratories Inc. | UL 1977 | 20151210- E45171 |

Counterpart

Compatible products

Subject to changes. Please also observe the further product documentation!

WAGO Kontakttechnik GmbH & Co. KG
 Hansastr. 27
 32423 Minden
 Phone: +49571 887-0 | Fax: +49571 887-169
 Email: info.de@wago.com | Web: www.wago.com

Do you have any questions about our products?
 We are always happy to take your call at +49 (571) 887-44222.

Coding

| | |
|---------------------------------------------------------------------------------------------------------------------------|----------------------------------------------------------------|
| Item no.: 769-435 Coding pin; for coding of female plugs; for carrier terminal blocks / male connectors; orange | www.wago.com/769-435 |
|---------------------------------------------------------------------------------------------------------------------------|----------------------------------------------------------------|

End plate



| | |
|----------------------------------------------------------------------------|----------------------------------------------------------------|
| Item no.: 769-307 End and intermediate plate; 1.1 mm thick; gray | www.wago.com/769-307 |
|----------------------------------------------------------------------------|----------------------------------------------------------------|



| | |
|------------------------------------------------------------------------------|----------------------------------------------------------------|
| Item no.: 769-308 End and intermediate plate; 1.1 mm thick; orange | www.wago.com/769-308 |
|------------------------------------------------------------------------------|----------------------------------------------------------------|

Marking accessories

| | |
|------------------------------------------------------------------------------------------------------------------------------------------|------------------------------------------------------------------|
| Item no.: 2009-145 Mini-WSB Inline; for Smart Printer; 1700 pieces on roll; stretchable 5 - 5.2 mm; plain; snap-on type; white | www.wago.com/2009-145 |
|------------------------------------------------------------------------------------------------------------------------------------------|------------------------------------------------------------------|

| | |
|-----------------------------------------------------------------------------------------------------------------------------------------------------------|----------------------------------------------------------------------------------|
| Item no.: 2009-145/000-002 Mini-WSB Inline; for Smart Printer; 1700 pieces on roll; stretchable 5 - 5.2 mm; plain; snap-on type; white /000-002 | www.wago.com/2009-145/000-002 |
|-----------------------------------------------------------------------------------------------------------------------------------------------------------|----------------------------------------------------------------------------------|

| | |
|---------------------------------------------------------------------------------------------------------------------------------------------------------|----------------------------------------------------------------------------------|
| Item no.: 2009-145/000-005 Mini-WSB Inline; for Smart Printer; 1700 pieces on roll; stretchable 5 - 5.2 mm; plain; snap-on type; red /000-005 | www.wago.com/2009-145/000-005 |
|---------------------------------------------------------------------------------------------------------------------------------------------------------|----------------------------------------------------------------------------------|

| | |
|----------------------------------------------------------------------------------------------------------------------------------------------------------|----------------------------------------------------------------------------------|
| Item no.: 2009-145/000-006 Mini-WSB Inline; for Smart Printer; 1700 pieces on roll; stretchable 5 - 5.2 mm; plain; snap-on type; blue /000-006 | www.wago.com/2009-145/000-006 |
|----------------------------------------------------------------------------------------------------------------------------------------------------------|----------------------------------------------------------------------------------|

| | |
|-----------------------------------------------------------------------------------------------------------------------------------------------------------|----------------------------------------------------------------------------------|
| Item no.: 2009-145/000-007 Mini-WSB Inline; for Smart Printer; 1700 pieces on roll; stretchable 5 - 5.2 mm; plain; snap-on type; white /000-007 | www.wago.com/2009-145/000-007 |
|-----------------------------------------------------------------------------------------------------------------------------------------------------------|----------------------------------------------------------------------------------|

| | |
|---------------------------------------------------------------------------------------------------------------------------------------------------|----------------------------------------------------------------------------------|
| Item no.: 2009-145/000-012 Mini-WSB Inline; for Smart Printer; 1700 pieces on roll; stretchable 5 - 5.2 mm; plain; snap-on type; orange | www.wago.com/2009-145/000-012 |
|---------------------------------------------------------------------------------------------------------------------------------------------------|----------------------------------------------------------------------------------|

| | |
|--------------------------------------------------------------------------------------------------------------------------------------------------|----------------------------------------------------------------------------------|
| Item no.: 2009-145/000-023 Mini-WSB Inline; for Smart Printer; 1700 pieces on roll; stretchable 5 - 5.2 mm; plain; snap-on type; green | www.wago.com/2009-145/000-023 |
|--------------------------------------------------------------------------------------------------------------------------------------------------|----------------------------------------------------------------------------------|

| | |
|---------------------------------------------------------------------------------------------------------------------------------------------------|----------------------------------------------------------------------------------|
| Item no.: 2009-145/000-024 Mini-WSB Inline; for Smart Printer; 1700 pieces on roll; stretchable 5 - 5.2 mm; plain; snap-on type; violet | www.wago.com/2009-145/000-024 |
|---------------------------------------------------------------------------------------------------------------------------------------------------|----------------------------------------------------------------------------------|

| | |
|------------------------------------------------------------------------------------------------------------------------------|----------------------------------------------------------------|
| Item no.: 248-501 Miniature WSB Quick marking system; plain; Marker width 5 mm; 10 strips with 10 markers per card | www.wago.com/248-501 |
|------------------------------------------------------------------------------------------------------------------------------|----------------------------------------------------------------|

Subject to changes. Please also observe the further product documentation!



Item no.: 248-501/000-002
Mini-WSB marking card; as card; not stretchable; plain; snap-on type; yellow

www.wago.com/248-501/000-002



Item no.: 248-501/000-005
Mini-WSB marking card; as card; not stretchable; plain; snap-on type; red

www.wago.com/248-501/000-005



Item no.: 248-501/000-006
Mini-WSB marking card; as card; not stretchable; plain; snap-on type; blue

www.wago.com/248-501/000-006



Item no.: 248-501/000-007
Mini-WSB marking card; as card; not stretchable; plain; snap-on type; gray

www.wago.com/248-501/000-007



Item no.: 248-501/000-012
Mini-WSB marking card; as card; not stretchable; plain; snap-on type; orange

www.wago.com/248-501/000-012

Item no.: 248-501/000-017
Mini-WSB marking card; as card; not stretchable; plain; snap-on type; light green

www.wago.com/248-501/000-017



Item no.: 248-501/000-023
Mini-WSB marking card; as card; not stretchable; plain; snap-on type; green

www.wago.com/248-501/000-023



Item no.: 248-501/000-024
Mini-WSB marking card; as card; not stretchable; plain; snap-on type; violet

www.wago.com/248-501/000-024

Insulation stop



Item no.: 769-470
Insulation stop; 0.08 - 0.2 mm² "s" (0.14 mm² "f-st"); 5 pieces/strip; white

www.wago.com/769-470



Item no.: 769-471
Insulation stop; 0.25 - 0.5 mm²; 5 pieces/strip; light gray

www.wago.com/769-471

Item no.: 769-472
Insulation stop; 0.75 - 1 mm²; 5 pieces/strip; dark gray

www.wago.com/769-472

ferrule

Item no.: 216-101
Ferrule; Sleeve for 0.5 mm² / AWG 22; uninsulated; electro-tin plated

www.wago.com/216-101

Item no.: 216-102
Ferrule; Sleeve for 0.75 mm² / AWG 20; uninsulated; electro-tin plated

www.wago.com/216-102

Item no.: 216-103
Ferrule; Sleeve for 1 mm² / AWG 18; uninsulated; electro-tin plated











www.wago.com/216-103











Item no.: 216-104
Ferrule; Sleeve for 1.5 mm² / AWG 16; uninsulated; electro-tin plated

www.wago.com/216-104













Subject to changes. Please also observe the further product documentation!

| | | |
|------------------------------------------------------------------------------------|-----------------------------------------------------------------------------------------------------------------------------------|----------------------------------------------------------------|
| | Item no.: 216-201 Ferrule; Sleeve for 0.5 mm ² / 20 AWG; insulated; electro-tin plated; white | www.wago.com/216-201 |
|  | Item no.: 216-202 Ferrule; Sleeve for 0.75 mm ² / 18 AWG; insulated; electro-tin plated; gray | www.wago.com/216-202 |
|  | Item no.: 216-203 Ferrule; Sleeve for 1 mm ² / AWG 18; insulated; electro-tin plated; red | www.wago.com/216-203 |
| | Item no.: 216-204 Ferrule; Sleeve for 1.5 mm ² / AWG 16; insulated; electro-tin plated; black | www.wago.com/216-204 |
| | Item no.: 216-206 Ferrule; Sleeve for 2.5 mm ² / AWG 14; insulated; electro-tin plated; blue | www.wago.com/216-206 |
| | Item no.: 216-301 Ferrule; Sleeve for 0.25 mm ² / AWG 24; insulated; electro-tin plated; yellow | www.wago.com/216-301 |
| | Item no.: 216-302 Ferrule; Sleeve for 0.34 mm ² / 22 AWG; insulated; electro-tin plated; green | www.wago.com/216-302 |
| Jumper | | |
| | Item no.: 249-123 Push-in type wire jumper; insulated; wire length 180 mm; Conductor cross section 0.75 mm ² | www.wago.com/249-123 |
|  | Item no.: 249-125 Push-in type wire jumper; insulated; wire length 60 mm; Conductor cross section 0.75 mm ² | www.wago.com/249-125 |
|  | Item no.: 249-126 Push-in type wire jumper; insulated; wire length 110 mm; Conductor cross section 0.75 mm ² | www.wago.com/249-126 |
|  | Item no.: 249-127 Push-in type wire jumper; insulated; wire length 250 mm; Conductor cross section 0.75 mm ² | www.wago.com/249-127 |
|  | Item no.: 280-402 Adjacent jumper; insulated; IN = IN terminal block; gray | www.wago.com/280-402 |
|  | Item no.: 280-409 Alternate jumper; insulated; IN = IN terminal block; gray | www.wago.com/280-409 |
|  | Item no.: 780-452 Staggered jumper; insulated; from 1 to 2; Spacing: 5 mm; suitable for 2-conductor female plugs; gray | www.wago.com/780-452 |
|  | Item no.: 780-453 Staggered jumper; insulated; from 1 to 3; Spacing: 5 mm; suitable for 2-conductor female plugs; gray | www.wago.com/780-453 |
| | Item no.: 780-454 Staggered jumper; insulated; from 1 to 4; Spacing: 5 mm; suitable for 2-conductor female plugs; gray | www.wago.com/780-454 |
|  | Item no.: 780-455 Staggered jumper; insulated; from 1 to 5; Spacing: 5 mm; suitable for 2-conductor female plugs; gray | www.wago.com/780-455 |
| | Item no.: 780-456 Staggered jumper; insulated; from 1 to 6; Spacing: 5 mm; suitable for 2-conductor female plugs; gray | www.wago.com/780-456 |

Subject to changes. Please also observe the further product documentation!

| | | |
|------------------------------------------------------------------------------------|-------------------------------------------------------------------------------------------------------------------------------------------------------------------------|--------------------------------------------------------------------------------|
|  | Item no.: 780-457 Staggered jumper; insulated; from 1 to 7; Spacing: 5 mm; suitable for 2-conductor female plugs; gray | www.wago.com/780-457 |
|  | Item no.: 780-458 Staggered jumper; insulated; from 1 to 8; Spacing: 5 mm; suitable for 2-conductor female plugs; gray | www.wago.com/780-458 |
| assembling | | |
|  | Item no.: 209-106 Mounting carrier; for isolated mounting on DIN 35 rails; gray | www.wago.com/209-106 |
| Test Accessories | | |
| | Item no.: 210-136 Test plug; 2 mm Ø; with 500 mm cable; red | www.wago.com/210-136 |
|  | Item no.: 210-137 Test plug; 2.3 mm Ø; with 500 mm cable; yellow | www.wago.com/210-137 |
|  | Item no.: 280-404 Test plug adapter; 5 mm wide; for test plug 210-137 (2.3 mm Ø); suitable for 1.5 mm ² - 4 mm ² tbs; gray | www.wago.com/280-404 |
| | Item no.: 280-418 Test plug module; modular; suitable for all WAGO 280 and 780 Series rail-mounted terminal blocks with jumper slots in the current bar; gray | www.wago.com/280-418 |
|  | Item no.: 280-419 Spacer module; modular; bridging commoned terminal blocks; gray | www.wago.com/280-419 |
| tools | | |
| | Item no.: 210-720 Operating tool; Blade: 3.5 x 0.5 mm; with a partially insulated shaft | www.wago.com/210-720 |
| Female plug | | |
| | Item no.: 769-101 1-conductor female plug; 4 mm ² ; 1-pole; 4,00 mm ² ; gray | www.wago.com/769-101 |
|  | Item no.: 769-101/000-006 1-conductor female plug; 4 mm ² ; 1-pole; 4,00 mm ² ; blue | www.wago.com/769-101/000-006 |
|  | Item no.: 769-101/000-016 1-conductor female plug; 4 mm ² ; 1-pole; 4,00 mm ² ; green-yellow | www.wago.com/769-101/000-016 |
| | Item no.: 769-101/022-000 1-conductor female plug; angled; 4 mm ² ; 1-pole; 4,00 mm ² ; gray | www.wago.com/769-101/022-000 |
|  | Item no.: 769-101/022-016 1-conductor female plug; angled; 4 mm ² ; 1-pole; 4,00 mm ² ; green-yellow | www.wago.com/769-101/022-016 |

Subject to changes. Please also observe the further product documentation!

| | | |
|------------------------------------------------------------------------------------|------------------------------------------------------------------------------------------------------------------------------------------|--------------------------------------------------------------------------------|
| | Item no.: 769-102 1-conductor female plug; 4 mm ² ; 2-pole; 4,00 mm ² ; gray | www.wago.com/769-102 |
|  | Item no.: 769-102/000-006 1-conductor female plug; 4 mm ² ; 2-pole; 4,00 mm ² ; blue | www.wago.com/769-102/000-006 |
|  | Item no.: 769-102/000-036 1-conductor female plug; 4 mm ² ; 2-pole; 4,00 mm ² ; gray, green-yellow | www.wago.com/769-102/000-036 |
|  | Item no.: 769-102/000-037 1-conductor female plug; 4 mm ² ; 2-pole; 4,00 mm ² ; green-yellow, gray | www.wago.com/769-102/000-037 |
|  | Item no.: 769-102/022-000 1-conductor female plug; angled; 4 mm ² ; 2-pole; 4,00 mm ² ; gray | www.wago.com/769-102/022-000 |
|  | Item no.: 769-103 1-conductor female plug; 4 mm ² ; 3-pole; 4,00 mm ² ; gray | www.wago.com/769-103 |
|  | Item no.: 769-103/000-006 1-conductor female plug; 4 mm ² ; 3-pole; 4,00 mm ² ; blue | www.wago.com/769-103/000-006 |
|  | Item no.: 769-103/000-036 1-conductor female plug; 4 mm ² ; 3-pole; 4,00 mm ² ; gray, green-yellow | www.wago.com/769-103/000-036 |
| | Item no.: 769-103/000-037 1-conductor female plug; 4 mm ² ; 3-pole; 4,00 mm ² ; green-yellow, gray | www.wago.com/769-103/000-037 |
|  | Item no.: 769-103/000-038 1-conductor female plug; 4 mm ² ; 3-pole; 4,00 mm ² ; gray, blue, green-yellow | www.wago.com/769-103/000-038 |
|  | Item no.: 769-103/000-039 1-conductor female plug; 4 mm ² ; 3-pole; 4,00 mm ² ; green-yellow, blue, gray | www.wago.com/769-103/000-039 |
|  | Item no.: 769-103/022-000 1-conductor female plug; angled; 4 mm ² ; 3-pole; 4,00 mm ² ; gray | www.wago.com/769-103/022-000 |
|  | Item no.: 769-104 1-conductor female plug; 4 mm ² ; 4-pole; 4,00 mm ² ; gray | www.wago.com/769-104 |
|  | Item no.: 769-104/000-006 1-conductor female plug; 4 mm ² ; 4-pole; 4,00 mm ² ; blue | www.wago.com/769-104/000-006 |

Subject to changes. Please also observe the further product documentation!



Item no.: 769-104/000-036
1-conductor female plug; 4 mm²; 4-pole; 4,00 mm²; gray, green-yellow

www.wago.com/769-104/000-036



Item no.: 769-104/000-037
1-conductor female plug; 4 mm²; 4-pole; 4,00 mm²; green-yellow, gray

www.wago.com/769-104/000-037

Item no.: 769-104/000-038
1-conductor female plug; 4 mm²; 4-pole; 4,00 mm²; gray, blue, green-yellow

www.wago.com/769-104/000-038



Item no.: 769-104/000-039
1-conductor female plug; 4 mm²; 4-pole; 4,00 mm²; green-yellow, blue, gray

www.wago.com/769-104/000-039



Item no.: 769-104/022-000
1-conductor female plug; angled; 4 mm²; 4-pole; 4,00 mm²; gray

www.wago.com/769-104/022-000



Item no.: 769-105
1-conductor female plug; 4 mm²; 5-pole; 4,00 mm²; gray

www.wago.com/769-105

Item no.: 769-105/000-006
1-conductor female plug; 4 mm²; 5-pole; 4,00 mm²; blue

www.wago.com/769-105/000-006



Item no.: 769-105/000-036
1-conductor female plug; 4 mm²; 5-pole; 4,00 mm²; gray, green-yellow

www.wago.com/769-105/000-036



Item no.: 769-105/000-037
1-conductor female plug; 4 mm²; 5-pole; 4,00 mm²; green-yellow, gray

www.wago.com/769-105/000-037

Item no.: 769-105/000-038
1-conductor female plug; 4 mm²; 5-pole; 4,00 mm²; gray, blue, green-yellow

www.wago.com/769-105/000-038

Item no.: 769-105/000-039
1-conductor female plug; 4 mm²; 5-pole; 4,00 mm²; green-yellow, blue, gray

www.wago.com/769-105/000-039



Item no.: 769-105/022-000
1-conductor female plug; angled; 4 mm²; 5-pole; 4,00 mm²; gray

www.wago.com/769-105/022-000

Item no.: 769-106
1-conductor female plug; 4 mm²; 6-pole; 4,00 mm²; gray

www.wago.com/769-106

Item no.: 769-106/000-006
1-conductor female plug; 4 mm²; 6-pole; 4,00 mm²; blue

www.wago.com/769-106/000-006

Subject to changes. Please also observe the further product documentation!



Item no.: 769-106/000-036
1-conductor female plug; 4 mm²; 6-pole; 4,00 mm²; gray, green-yellow

www.wago.com/769-106/000-036



Item no.: 769-106/000-037
1-conductor female plug; 4 mm²; 6-pole; 4,00 mm²; green-yellow, gray

www.wago.com/769-106/000-037

Item no.: 769-106/000-038
1-conductor female plug; 4 mm²; 6-pole; 4,00 mm²; gray, blue, green-yellow

www.wago.com/769-106/000-038



Item no.: 769-106/000-039
1-conductor female plug; 4 mm²; 6-pole; 4,00 mm²; green-yellow, blue, gray

www.wago.com/769-106/000-039



Item no.: 769-106/022-000
1-conductor female plug; angled; 4 mm²; 6-pole; 4,00 mm²; gray

www.wago.com/769-106/022-000

Item no.: 769-107
1-conductor female plug; 4 mm²; 7-pole; 4,00 mm²; gray

www.wago.com/769-107



Item no.: 769-107/000-006
1-conductor female plug; 4 mm²; 7-pole; 4,00 mm²; blue

www.wago.com/769-107/000-006

Item no.: 769-107/000-036
1-conductor female plug; 4 mm²; 7-pole; 4,00 mm²; gray, green-yellow

www.wago.com/769-107/000-036

Item no.: 769-107/000-037
1-conductor female plug; 4 mm²; 7-pole; 4,00 mm²; green-yellow, gray

www.wago.com/769-107/000-037



Item no.: 769-107/000-038
1-conductor female plug; 4 mm²; 7-pole; 4,00 mm²; gray, blue, green-yellow

www.wago.com/769-107/000-038



Item no.: 769-107/000-039
1-conductor female plug; 4 mm²; 7-pole; 4,00 mm²; green-yellow, blue, gray

www.wago.com/769-107/000-039



Item no.: 769-107/022-000
1-conductor female plug; angled; 4 mm²; 7-pole; 4,00 mm²; gray

www.wago.com/769-107/022-000



Item no.: 769-108
1-conductor female plug; 4 mm²; 8-pole; 4,00 mm²; gray

www.wago.com/769-108



Item no.: 769-108/000-006
1-conductor female plug; 4 mm²; 8-pole; 4,00 mm²; blue

www.wago.com/769-108/000-006

Subject to changes. Please also observe the further product documentation!



Item no.: 769-108/000-036
1-conductor female plug; 4 mm²; 8-pole; 4,00 mm²; gray, green-yellow

www.wago.com/769-108/000-036

Item no.: 769-108/000-037
1-conductor female plug; 4 mm²; 8-pole; 4,00 mm²; green-yellow, gray

www.wago.com/769-108/000-037



Item no.: 769-108/000-038
1-conductor female plug; 4 mm²; 8-pole; 4,00 mm²; gray, blue, green-yellow

www.wago.com/769-108/000-038



Item no.: 769-108/000-039
1-conductor female plug; 4 mm²; 8-pole; 4,00 mm²; green-yellow, blue, gray

www.wago.com/769-108/000-039



Item no.: 769-108/022-000
1-conductor female plug; angled; 4 mm²; 8-pole; 4,00 mm²; gray

www.wago.com/769-108/022-000



Item no.: 769-109
1-conductor female plug; 4 mm²; 9-pole; 4,00 mm²; gray

www.wago.com/769-109



Item no.: 769-109/000-006
1-conductor female plug; 4 mm²; 9-pole; 4,00 mm²; blue

www.wago.com/769-109/000-006



Item no.: 769-109/000-036
1-conductor female plug; 4 mm²; 9-pole; 4,00 mm²; gray, green-yellow

www.wago.com/769-109/000-036



Item no.: 769-109/000-037
1-conductor female plug; 4 mm²; 9-pole; 4,00 mm²; green-yellow, gray

www.wago.com/769-109/000-037



Item no.: 769-109/000-038
1-conductor female plug; 4 mm²; 9-pole; 4,00 mm²; gray, blue, green-yellow

www.wago.com/769-109/000-038



Item no.: 769-109/000-039
1-conductor female plug; 4 mm²; 9-pole; 4,00 mm²; green-yellow, blue, gray

www.wago.com/769-109/000-039



Item no.: 769-109/022-000
1-conductor female plug; angled; 4 mm²; 9-pole; 4,00 mm²; gray

www.wago.com/769-109/022-000



Item no.: 769-110
1-conductor female plug; 4 mm²; 10-pole; 4,00 mm²; gray















www.wago.com/769-110



Item no.: 769-110/000-006
1-conductor female plug; 4 mm²; 10-pole; 4,00 mm²; blue

www.wago.com/769-110/000-006

Subject to changes. Please also observe the further product documentation!

| | | |
|------------------------------------------------------------------------------------|-----------------------------------------------------------------------------------------------------------------------------------------------|--------------------------------------------------------------------------------|
|  | <p>Item no.: 769-110/000-036 1-conductor female plug; 4 mm²; 10-pole; 4,00 mm²; gray, green-yellow</p> | www.wago.com/769-110/000-036 |
|  | <p>Item no.: 769-110/000-037 1-conductor female plug; 4 mm²; 10-pole; 4,00 mm²; green-yellow, gray</p> | www.wago.com/769-110/000-037 |
|  | <p>Item no.: 769-110/000-038 1-conductor female plug; 4 mm²; 10-pole; 4,00 mm²; gray, blue, green-yellow</p> | www.wago.com/769-110/000-038 |
|  | <p>Item no.: 769-110/000-039 1-conductor female plug; 4 mm²; 10-pole; 4,00 mm²; green-yellow, blue, gray</p> | www.wago.com/769-110/000-039 |
|  | <p>Item no.: 769-110/022-000 1-conductor female plug; angled; 4 mm²; 10-pole; 4,00 mm²; gray</p> | www.wago.com/769-110/022-000 |
|  | <p>Item no.: 769-111 1-conductor female plug; 4 mm²; 11-pole; 4,00 mm²; gray</p> | www.wago.com/769-111 |
|  | <p>Item no.: 769-111/000-006 1-conductor female plug; 4 mm²; 11-pole; 4,00 mm²; blue</p> | www.wago.com/769-111/000-006 |
|  | <p>Item no.: 769-111/000-036 1-conductor female plug; 4 mm²; 11-pole; 4,00 mm²; gray, green-yellow</p> | www.wago.com/769-111/000-036 |
|  | <p>Item no.: 769-111/000-037 1-conductor female plug; 4 mm²; 11-pole; 4,00 mm²; green-yellow, gray</p> | www.wago.com/769-111/000-037 |
|  | <p>Item no.: 769-111/000-038 1-conductor female plug; 4 mm²; 11-pole; 4,00 mm²; gray, blue, green-yellow</p> | www.wago.com/769-111/000-038 |
|  | <p>Item no.: 769-111/000-039 1-conductor female plug; 4 mm²; 11-pole; 4,00 mm²; green-yellow, blue, gray</p> | www.wago.com/769-111/000-039 |
|  | <p>Item no.: 769-111/022-000 1-conductor female plug; angled; 4 mm²; 11-pole; 4,00 mm²; gray</p> | www.wago.com/769-111/022-000 |
|  | <p>Item no.: 769-112 1-conductor female plug; 4 mm²; 12-pole; 4,00 mm²; gray</p> | www.wago.com/769-112 |
|  | <p>Item no.: 769-112/000-006 1-conductor female plug; 4 mm²; 12-pole; 4,00 mm²; blue</p> | www.wago.com/769-112/000-006 |

Subject to changes. Please also observe the further product documentation!



Item no.: 769-112/000-036
1-conductor female plug; 4 mm²; 12-pole; 4,00 mm²; gray, green-yellow

www.wago.com/769-112/000-036



Item no.: 769-112/000-037
1-conductor female plug; 4 mm²; 12-pole; 4,00 mm²; green-yellow, gray

www.wago.com/769-112/000-037



Item no.: 769-112/000-038
1-conductor female plug; 4 mm²; 12-pole; 4,00 mm²; gray, blue, green-yellow

www.wago.com/769-112/000-038



Item no.: 769-112/000-039
1-conductor female plug; 4 mm²; 12-pole; 4,00 mm²; green-yellow, blue, gray

www.wago.com/769-112/000-039



Item no.: 769-112/022-000
1-conductor female plug; angled; 4 mm²; 12-pole; 4,00 mm²; gray

www.wago.com/769-112/022-000



Item no.: 769-113
1-conductor female plug; 4 mm²; 13-pole; 4,00 mm²; gray

www.wago.com/769-113



Item no.: 769-113/000-036
1-conductor female plug; 4 mm²; 13-pole; 4,00 mm²; gray, green-yellow

www.wago.com/769-113/000-036



Item no.: 769-113/000-037
1-conductor female plug; 4 mm²; 13-pole; 4,00 mm²; green-yellow, gray

www.wago.com/769-113/000-037



Item no.: 769-113/000-038
1-conductor female plug; 4 mm²; 13-pole; 4,00 mm²; gray, blue, green-yellow

www.wago.com/769-113/000-038



Item no.: 769-113/000-039
1-conductor female plug; 4 mm²; 13-pole; 4,00 mm²; green-yellow, blue, gray

www.wago.com/769-113/000-039



Item no.: 769-113/022-000
1-conductor female plug; angled; 4 mm²; 13-pole; 4,00 mm²; gray

www.wago.com/769-113/022-000



Item no.: 769-114
1-conductor female plug; 4 mm²; 14-pole; 4,00 mm²; gray

www.wago.com/769-114



Item no.: 769-114/000-006
1-conductor female plug; 4 mm²; 14-pole; 4,00 mm²; blue















www.wago.com/769-114/000-006



Item no.: 769-114/000-036
1-conductor female plug; 4 mm²; 14-pole; 4,00 mm²; gray, green-yellow

www.wago.com/769-114/000-036

Subject to changes. Please also observe the further product documentation!

| | | |
|------------------------------------------------------------------------------------|-------------------------------------------------------------------------------------------------------------------------------------------|--------------------------------------------------------------------------------|
|  | Item no.: 769-114/000-037 1-conductor female plug; 4 mm ² ; 14-pole; 4,00 mm ² ; green-yellow, gray | www.wago.com/769-114/000-037 |
|  | Item no.: 769-114/000-038 1-conductor female plug; 4 mm ² ; 14-pole; 4,00 mm ² ; gray, blue, green-yellow | www.wago.com/769-114/000-038 |
|  | Item no.: 769-114/000-039 1-conductor female plug; 4 mm ² ; 14-pole; 4,00 mm ² ; green-yellow, blue, gray | www.wago.com/769-114/000-039 |
|  | Item no.: 769-114/022-000 1-conductor female plug; angled; 4 mm ² ; 14-pole; 4,00 mm ² ; gray | www.wago.com/769-114/022-000 |
|  | Item no.: 769-115 1-conductor female plug; 4 mm ² ; 15-pole; 4,00 mm ² ; gray | www.wago.com/769-115 |
|  | Item no.: 769-115/000-036 1-conductor female plug; 4 mm ² ; 15-pole; 4,00 mm ² ; gray, green-yellow | www.wago.com/769-115/000-036 |
|  | Item no.: 769-115/000-037 1-conductor female plug; 4 mm ² ; 15-pole; 4,00 mm ² ; green-yellow, gray | www.wago.com/769-115/000-037 |
|  | Item no.: 769-115/000-038 1-conductor female plug; 4 mm ² ; 15-pole; 4,00 mm ² ; gray, blue, green-yellow | www.wago.com/769-115/000-038 |
|  | Item no.: 769-115/000-039 1-conductor female plug; 4 mm ² ; 15-pole; 4,00 mm ² ; green-yellow, blue, gray | www.wago.com/769-115/000-039 |
|  | Item no.: 769-115/022-000 1-conductor female plug; angled; 4 mm ² ; 15-pole; 4,00 mm ² ; gray | www.wago.com/769-115/022-000 |
|  | Item no.: 769-121 2-conductor female connector; 4 mm ² ; 1-pole; 4,00 mm ² ; gray | www.wago.com/769-121 |
|  | Item no.: 769-121/000-016 2-conductor female connector; 4 mm ² ; 1-pole; 4,00 mm ² ; green-yellow | www.wago.com/769-121/000-016 |
|  | Item no.: 769-122 2-conductor female connector; 4 mm ² ; 2-pole; 4,00 mm ² ; gray | www.wago.com/769-122 |
|  | Item no.: 769-123 2-conductor female connector; 4 mm ² ; 3-pole; 4,00 mm ² ; gray | www.wago.com/769-123 |
|  | Item no.: 769-124 2-conductor female connector; 4 mm ² ; 4-pole; 4,00 mm ² ; gray | www.wago.com/769-124 |

Subject to changes. Please also observe the further product documentation!



Item no.: 769-125
2-conductor female connector; 4 mm²; 5-pole; 4,00 mm²; gray

www.wago.com/769-125



Item no.: 769-126
2-conductor female connector; 4 mm²; 6-pole; 4,00 mm²; gray

www.wago.com/769-126



Item no.: 769-127
2-conductor female connector; 4 mm²; 7-pole; 4,00 mm²; gray

www.wago.com/769-127



Item no.: 769-128
2-conductor female connector; 4 mm²; 8-pole; 4,00 mm²; gray

www.wago.com/769-128



Item no.: 769-129
2-conductor female connector; 4 mm²; 9-pole; 4,00 mm²; gray

www.wago.com/769-129



Item no.: 769-130
2-conductor female connector; 4 mm²; 10-pole; 4,00 mm²; gray

www.wago.com/769-130



Item no.: 769-131
2-conductor female connector; 4 mm²; 11-pole; 4,00 mm²; gray

www.wago.com/769-131



Item no.: 769-132
2-conductor female connector; 4 mm²; 12-pole; 4,00 mm²; gray

www.wago.com/769-132



Item no.: 769-133
2-conductor female connector; 4 mm²; 13-pole; 4,00 mm²; gray

www.wago.com/769-133



Item no.: 769-134
2-conductor female connector; 4 mm²; 14-pole; 4,00 mm²; gray

www.wago.com/769-134



Item no.: 769-135
2-conductor female connector; 4 mm²; 15-pole; 4,00 mm²; gray

www.wago.com/769-135

Protective Warning Marker

Item no.: 280-415
Protective warning marker; with high-voltage symbol, black; for 5 terminal blocks; yellow

www.wago.com/280-415

Carrier rail

Item no.: 210-112
Steel carrier rail; 35 x 7.5 mm; 1 mm thick; 2 m long; slotted; according to EN 60715; "Hole width 25 mm

www.wago.com/210-112

Item no.: 210-113
Steel carrier rail; 35 x 7.5 mm; 1 mm thick; 2 m long; unslotted; according to EN 60715

www.wago.com/210-113

Item no.: 210-114
Steel carrier rail; 35 x 15 mm; 1.5 mm thick; 2 m long; unslotted; similar to EN 60715

www.wago.com/210-114

Item no.: 210-115
Steel carrier rail; 35 x 7.5 mm; 1 mm thick; 2 m long; slotted; according to EN 60715; "Hole width 18 mm













www.wago.com/210-115















Item no.: 210-118
Steel carrier rail; 35 x 15 mm; 2.3 mm thick; 2 m long; unslotted; according to EN 60715

www.wago.com/210-118

Subject to changes. Please also observe the further product documentation!

| | | |
|------------------------------------------------------------------------------------|-------------------------------------------------------------------------------------------------------------------------------------------------------------------------------|--------------------------------------------------------------------------------|
|  | Item no.: 210-196 Aluminum carrier rail; 35 x 8.2 mm; 1.6 mm thick; 2 m long; unslotted; similar to EN 60715; silver-colored | www.wago.com/210-196 |
|  | Item no.: 210-197 Steel carrier rail; 35 x 15 mm; 1.5 mm thick; 2 m long; slotted; similar to EN 60715 | www.wago.com/210-197 |
|  | Item no.: 210-198 Copper carrier rail; 35 x 15 mm; 2.3 mm thick; 2 m long; unslotted; according to EN 60715; copper-colored | www.wago.com/210-198 |
| | Item no.: 210-504 Steel carrier rail; 35 x 7.5 mm; 1 mm thick; 2 m long; slotted; galvanized; according to EN 60715 | www.wago.com/210-504 |
|  | Item no.: 210-505 Steel carrier rail; 35 x 7.5 mm; 1 mm thick; 2 m long; unslotted; galvanized; according to EN 60715 | www.wago.com/210-505 |
|  | Item no.: 210-506 Steel carrier rail; 35 x 15 mm; 1.5 mm thick; 2 m long; unslotted; galvanized; similar to EN 60715 | www.wago.com/210-506 |
|  | Item no.: 210-508 Steel carrier rail; 35 x 15 mm; 1.5 mm thick; 2 m long; slotted; galvanized; similar to EN 60715 | www.wago.com/210-508 |
| General accessories | | |
|  | Item no.: 769-438 Pin cover; with marker slot for miniature WSB; gray | www.wago.com/769-438 |
|  | Item no.: 769-439 Pin cover; with marker slot for miniature WSB; orange | www.wago.com/769-439 |
|  | Item no.: 769-501 Start module for 1-conductor female connector; with integrated end plate; 4 mm ² ; 1-pole; 4,00 mm ² ; gray | www.wago.com/769-501 |
|  | Item no.: 769-501/000-006 Start module for 1-conductor female connector; 4 mm ² ; 1-pole; 4,00 mm ² ; blue | www.wago.com/769-501/000-006 |
|  | Item no.: 769-501/000-016 Start module for 1-conductor female connector; with integrated end plate; 4 mm ² ; 1-pole; 4,00 mm ² ; green-yellow | www.wago.com/769-501/000-016 |
|  | Item no.: 769-502 Center module for 1-conductor female connector; 4 mm ² ; 1-pole; 4,00 mm ² ; gray | www.wago.com/769-502 |
| | Item no.: 769-502/000-006 Center module for 1-conductor female connector; 4 mm ² ; 1-pole; 4,00 mm ² ; blue | www.wago.com/769-502/000-006 |
|  | Item no.: 769-502/000-016 Center module for 1-conductor female connector; 4 mm ² ; 1-pole; 4,00 mm ² ; green-yellow | www.wago.com/769-502/000-016 |
| | Item no.: 769-503 End module for 1-conductor female connector; 4 mm ² ; 1-pole; 4,00 mm ² ; gray | www.wago.com/769-503 |

Subject to changes. Please also observe the further product documentation!

| | | |
|------------------------------------------------------------------------------------|-----------------------------------------------------------------------------------------------------------------------------------------------------------------------|--------------------------------------------------------------------------------|
|  | Item no.: 769-503/000-006 End module for 1-conductor female connector; 4 mm ² ; 1-pole; 4,00 mm ² ; blue | www.wago.com/769-503/000-006 |
|  | Item no.: 769-503/000-016 End module for 1-conductor female connector; 4 mm ² ; 1-pole; 4,00 mm ² ; green-yellow | www.wago.com/769-503/000-016 |
|  | Item no.: 769-504 Start module for 2-conductor female connector; with integrated end plate; 4 mm ² ; 1-pole; 4,00 mm ² ; gray | www.wago.com/769-504 |
|  | Item no.: 769-504/000-006 Start module for 2-conductor female connector; with integrated end plate; 4 mm ² ; 1-pole; 4,00 mm ² ; blue | www.wago.com/769-504/000-006 |
|  | Item no.: 769-504/000-016 Start module for 2-conductor female connector; 4 mm ² ; 1-pole; 4,00 mm ² ; green-yellow | www.wago.com/769-504/000-016 |
|  | Item no.: 769-505 Center module for 2-conductor female connector; 4 mm ² ; 1-pole; 4,00 mm ² ; gray | www.wago.com/769-505 |
|  | Item no.: 769-505/000-006 Center module for 2-conductor female connector; 4 mm ² ; 1-pole; 4,00 mm ² ; blue | www.wago.com/769-505/000-006 |
|  | Item no.: 769-505/000-016 Center module for 2-conductor female connector; 4 mm ² ; 1-pole; 4,00 mm ² ; green-yellow | www.wago.com/769-505/000-016 |
| | Item no.: 769-506 End module for 2-conductor female connector; 4 mm ² ; 1-pole; 4,00 mm ² ; gray | www.wago.com/769-506 |
|  | Item no.: 769-506/000-006 End module for 2-conductor female connector; 4 mm ² ; 1-pole; 4,00 mm ² ; blue | www.wago.com/769-506/000-006 |
|  | Item no.: 769-506/000-016 End module for 2-conductor female connector; 4 mm ² ; 1-pole; 4,00 mm ² ; green-yellow | www.wago.com/769-506/000-016 |
|  | Item no.: 769-512 Start module for 1-conductor female connector; angled; 4 mm ² ; 1-pole; 4,00 mm ² ; gray | www.wago.com/769-512 |
|  | Item no.: 769-512/000-006 Start module for 1-conductor female connector; angled; 4 mm ² ; 1-pole; 4,00 mm ² ; blue | www.wago.com/769-512/000-006 |
|  | Item no.: 769-512/000-016 Start module for 1-conductor female connector; angled; 4 mm ² ; 1-pole; 4,00 mm ² ; green-yellow | www.wago.com/769-512/000-016 |
| | Item no.: 769-513 Center module for 1-conductor female connector; angled; 4 mm ² ; 1-pole; 4,00 mm ² ; gray | www.wago.com/769-513 |

Subject to changes. Please also observe the further product documentation!



Item no.: 769-513/000-006

Center module for 1-conductor female connector; angled; 4 mm²; 1-pole; 4,00 mm²; blue

www.wago.com/769-513/000-006



Item no.: 769-513/000-016

Center module for 1-conductor female connector; angled; 4 mm²; 1-pole; 4,00 mm²; green-yellow

www.wago.com/769-513/000-016



Item no.: 769-515

End module for 1-conductor female connector; angled; 4 mm²; 1-pole; 4,00 mm²; gray

www.wago.com/769-515



Item no.: 769-515/000-006

End module for 1-conductor female connector; angled; 4 mm²; 1-pole; 4,00 mm²; blue

www.wago.com/769-515/000-006



Item no.: 769-515/000-016

End module for 1-conductor female connector; angled; 4 mm²; 1-pole; 4,00 mm²; green-yellow

www.wago.com/769-515/000-016

Downloads

Documentation

Additional Information

| | | | |
|------------------------|-------------|---------------|----------|
| Technical explanations | Apr 3, 2019 | pdf 2.1 MB | Download |
|------------------------|-------------|---------------|----------|

CAD/CAE-Data

CAD data

| | | |
|----------------------|-----|----------|
| 2D/3D Models 769-176 | URL | Download |
|----------------------|-----|----------|

CAE data

| | | |
|---------------------------|-----|----------|
| EPLAN Data Portal 769-176 | URL | Download |
|---------------------------|-----|----------|

| | | |
|------------------------|-----|----------|
| WSCAD Universe 769-176 | URL | Download |
|------------------------|-----|----------|

Installation Notes

Assembly

Subject to changes. Please also observe the further product documentation!

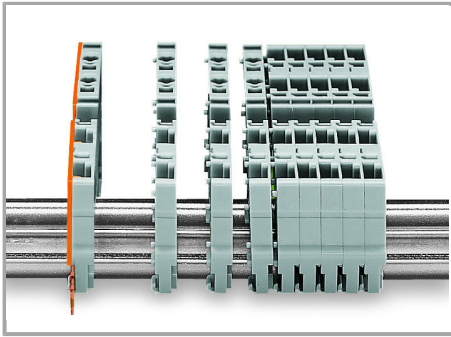

Snap individual carrier terminal blocks onto the carrier rail and slide together.

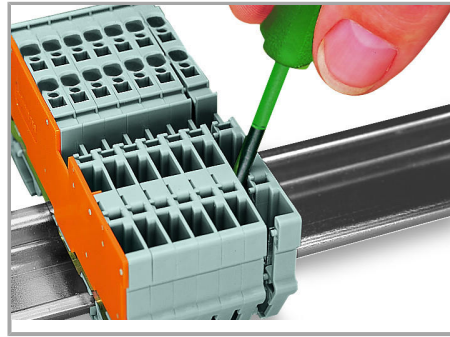

Open the assembly by laterally sliding a block via operating tool and remove terminal block via release lever.

Inserting a conductor

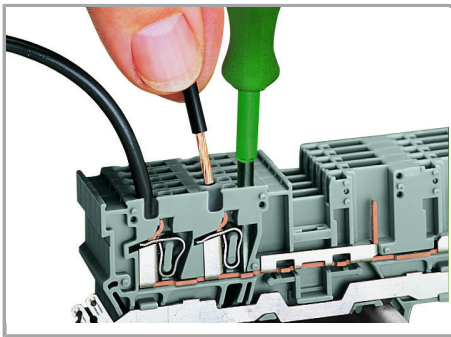

CAGE CLAMP® connection

Carrier terminal block: Insert/remove conductor via operating tool (3.5 x 0.5 mm blade).

Jumpered

Subject to changes. Please also observe the further product documentation!

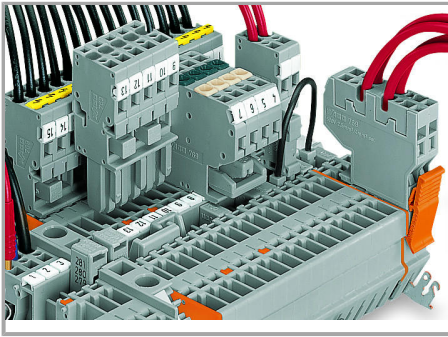

Commoning with adjacent or staggered jumpers –

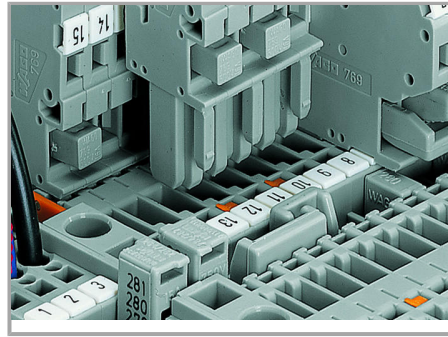

Commoning carrier terminal blocks via staggered jumpers.

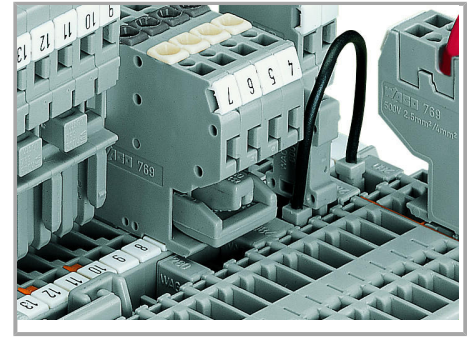

Commoning a 2-conductor female plug via staggered jumper and carrier terminal blocks via adjacent jumpers.

push jumpers down until fully inserted.

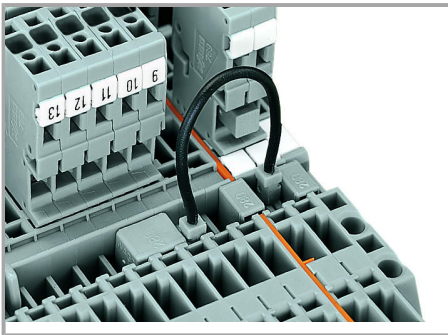

Commoning carrier terminal blocks via push-in type wire jumpers or adjacent jumpers – even over an intermediate plate.

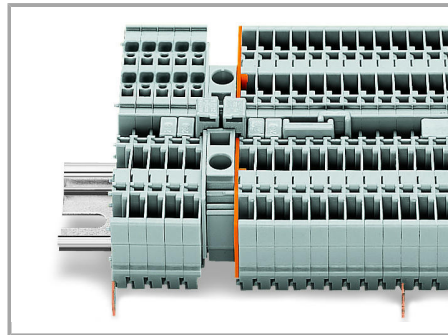

Commoning "supply terminal blocks" (up to 10 mm²/8 AWG) with carrier terminal blocks via step-down jumpers.

Testing

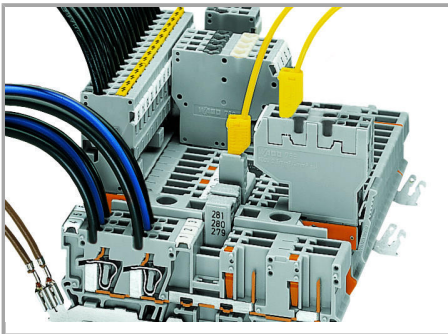

Testing via 2 or 2.3 mm Ø test plugs.

Subject to changes. Please also observe the further product documentation!

Coding

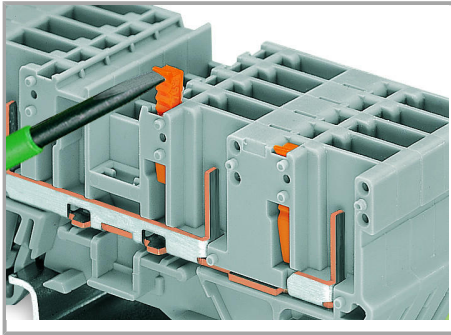

Snap coding pin in proper direction on carrier terminal block.

Shown: Coding pin removal from carrier terminal block.

Locking

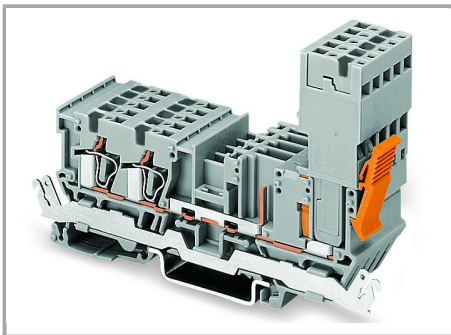

Female plug secured with locking lever on the terminal block side.

Subject to changes. Please also observe the further product documentation!

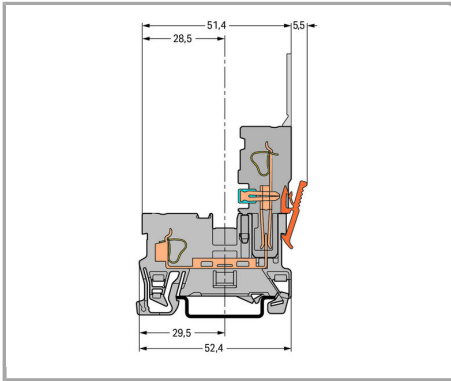

Carrier terminal block

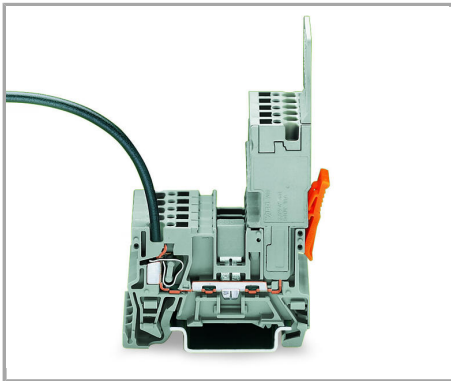

1-conductor female plug Carrier terminal blocks can be commoned via 280 and 780 Series Jumpers and tested using a 280 Series Test Plug Adapter.

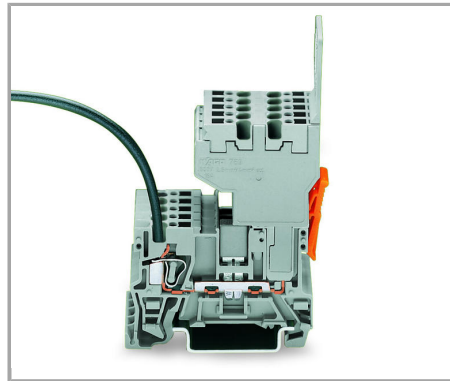

2-conductor female plug

Carrier terminal blocks can only be commoned via 280 Series Adjacent and Alternate Jumpers.

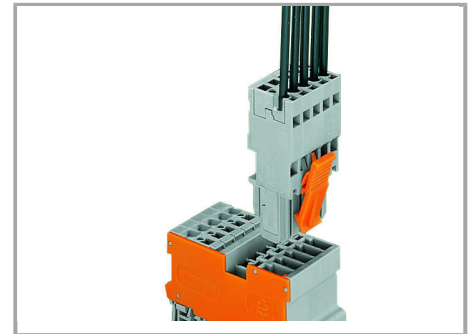

1-conductor/1-pin carrier terminal block

1-connector female plug, straight*

*1-conductor angled female plug is also possible!

Product family

X-COM

[Learn more about the product family.](#)

[Show all products from the family](#)

Subject to changes. Please also observe the further product documentation!