

Data sheet | Item number: 769-165/769-313

2-pin terminal block for pluggable modules; 10-pole; with 2 jumper positions; with orange separator plate; for DIN-rail 35 x 15 and 35 x 7.5; gray

www.wago.com/769-165/769-313

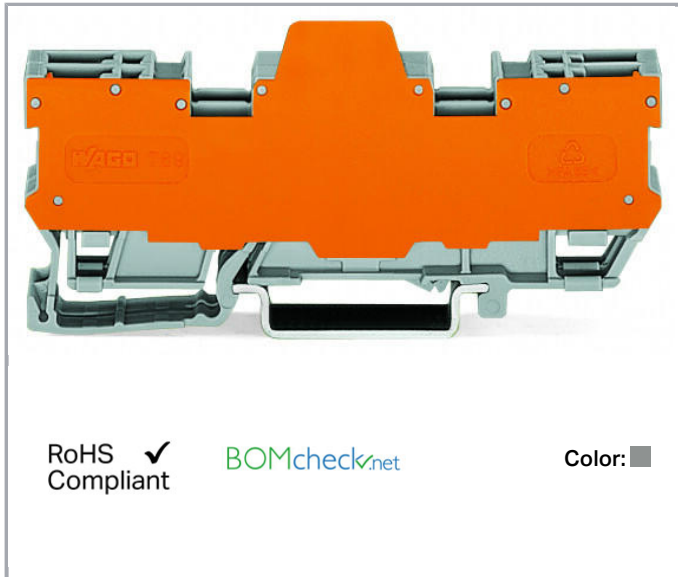

Data

Electrical data

Ratings per IEC/EN 60664-1

Rated voltage (III / 3)	400 V
Rated impulse voltage (III / 3)	6 kV
Rated current	16 A
Legend (ratings)	(III / 3) $\hat{=}$ Overvoltage category III / Pollution degree 3

Connection data

No. of poles	10
Total number of potentials	10
Number of levels	1
Type of wiring	Front-entry wiring

Geometrical Data

Width	26.1 mm / 1.028 inch
Height from upper-edge of DIN-35 rail	28.5 mm / 1.122 inch

Subject to changes. Please also observe the further product documentation!

WAGO Kontakttechnik GmbH & Co. KG
Hansastr. 27
32423 Minden
Phone: +49571 887-0 | Fax: +49571 887-169
Email: info.de@wago.com | Web: www.wago.com

Do you have any questions about our products?
We are always happy to take your call at +49 (571) 887-44222.

Depth	87.5 mm / 3.445 inch
-------	----------------------

Mechanical data

Design	horizontal
Type of mounting	DIN-35 rail
Marking level	Center marking

Material Data



Color	gray
Insulating material	Polyamide 66 (PA 66)
Fire load	0.903 MJ
Weight	40.8 g

Commercial data

Product Group	18 (X-COM-System)
Packaging type	BOX
Country of origin	DE
GTIN	4044918630245
Customs Tariff No.	85369010000

Approvals / Certificates



Country specific Approvals

Logo	Approval	Additional Approval Text	Certificate name
	CCA DEKRA Certification B.V.	EN 60947	NTR NL-7626
	CSA DEKRA Certification B.V.	C22.2 No. 158	1101144
	KEMA/KEUR DEKRA Certification B.V.	EN 60947	2190419.01



Ship Approvals

Certificate

Subject to changes. Please also observe the further product documentation!

Logo	Approval	Additional Approval Text	name
	ABS American Bureau of Shipping	EN 60947	20- HG1941090- PDA
	DNV GL Det Norske Veritas, Germanischer Lloyd	-	TAE00001V2

UL-Approvals

Logo	Approval	Additional Approval Text	Certificate name
	UR Underwriters Laboratories Inc.	UL 1059	20190731- E45172
	UR Underwriters Laboratories Inc.	UL 1977	20151210- E45171

Counterpart



Item no.769-105
1-conductor female plug; 4 mm²; 5-pole; 4,00 mm²; gray

www.wago.com/769-105









Item no.769-105/022-000
1-conductor female plug; angled; 4 mm²; 5-pole; 4,00 mm²; gray

www.wago.com/769-105/022-000











Compatible products

Subject to changes. Please also observe the further product documentation!

Carrier rail

	Item no.: 210-112 Steel carrier rail; 35 x 7.5 mm; 1 mm thick; 2 m long; slotted; according to EN 60715; "Hole width 25 mm	www.wago.com/210-112
	Item no.: 210-113 Steel carrier rail; 35 x 7.5 mm; 1 mm thick; 2 m long; unslotted; according to EN 60715	www.wago.com/210-113
	Item no.: 210-114 Steel carrier rail; 35 x 15 mm; 1.5 mm thick; 2 m long; unslotted; similar to EN 60715	www.wago.com/210-114
	Item no.: 210-115 Steel carrier rail; 35 x 7.5 mm; 1 mm thick; 2 m long; slotted; according to EN 60715; "Hole width 18 mm	www.wago.com/210-115
	Item no.: 210-118 Steel carrier rail; 35 x 15 mm; 2.3 mm thick; 2 m long; unslotted; according to EN 60715	www.wago.com/210-118
	Item no.: 210-196 Aluminum carrier rail; 35 x 8.2 mm; 1.6 mm thick; 2 m long; unslotted; similar to EN 60715; silver-colored	www.wago.com/210-196
	Item no.: 210-197 Steel carrier rail; 35 x 15 mm; 1.5 mm thick; 2 m long; slotted; similar to EN 60715	www.wago.com/210-197
	Item no.: 210-198 Copper carrier rail; 35 x 15 mm; 2.3 mm thick; 2 m long; unslotted; according to EN 60715; copper-colored	www.wago.com/210-198
	Item no.: 210-504 Steel carrier rail; 35 x 7.5 mm; 1 mm thick; 2 m long; slotted; galvanized; according to EN 60715	www.wago.com/210-504
	Item no.: 210-505 Steel carrier rail; 35 x 7.5 mm; 1 mm thick; 2 m long; unslotted; galvanized; according to EN 60715	www.wago.com/210-505
	Item no.: 210-506 Steel carrier rail; 35 x 15 mm; 1.5 mm thick; 2 m long; unslotted; galvanized; similar to EN 60715	www.wago.com/210-506
	Item no.: 210-508 Steel carrier rail; 35 x 15 mm; 1.5 mm thick; 2 m long; slotted; galvanized; similar to EN 60715	www.wago.com/210-508
Marking accessories		
	Item no.: 2009-145 Mini-WSB Inline; for Smart Printer; 1700 pieces on roll; stretchable 5 - 5.2 mm; plain; snap-on type; white	www.wago.com/2009-145
	Item no.: 2009-145/000-002 Mini-WSB Inline; for Smart Printer; 1700 pieces on roll; stretchable 5 - 5.2 mm; plain; snap-on type; white	www.wago.com/2009-145/000-002
	Item no.: 2009-145/000-005	

Subject to changes. Please also observe the further product documentation!

	Mini-WSB Inline; for Smart Printer; 1700 pieces on roll; stretchable 5 - 5.2 mm; plain; snap-on type; red	www.wago.com/2009-145/000-005
	Item no.: 2009-145/000-006 Mini-WSB Inline; for Smart Printer; 1700 pieces on roll; stretchable 5 - 5.2 mm; plain; snap-on type; blue	www.wago.com/2009-145/000-006
	Item no.: 2009-145/000-007 Mini-WSB Inline; for Smart Printer; 1700 pieces on roll; stretchable 5 - 5.2 mm; plain; snap-on type; white	www.wago.com/2009-145/000-007
	Item no.: 2009-145/000-012 Mini-WSB Inline; for Smart Printer; 1700 pieces on roll; stretchable 5 - 5.2 mm; plain; snap-on type; orange	www.wago.com/2009-145/000-012
	Item no.: 2009-145/000-023 Mini-WSB Inline; for Smart Printer; 1700 pieces on roll; stretchable 5 - 5.2 mm; plain; snap-on type; green	www.wago.com/2009-145/000-023
	Item no.: 2009-145/000-024 Mini-WSB Inline; for Smart Printer; 1700 pieces on roll; stretchable 5 - 5.2 mm; plain; snap-on type; violet	www.wago.com/2009-145/000-024
	Item no.: 248-501 Miniature WSB Quick marking system; plain; Marker width 5 mm; 10 strips with 10 markers per card	www.wago.com/248-501
	Item no.: 248-501/000-002 Mini-WSB marking card; as card; not stretchable; plain; snap-on type; yellow	www.wago.com/248-501/000-002
	Item no.: 248-501/000-005 Mini-WSB marking card; as card; not stretchable; plain; snap-on type; red	www.wago.com/248-501/000-005
	Item no.: 248-501/000-006 Mini-WSB marking card; as card; not stretchable; plain; snap-on type; blue	www.wago.com/248-501/000-006
	Item no.: 248-501/000-007 Mini-WSB marking card; as card; not stretchable; plain; snap-on type; gray	www.wago.com/248-501/000-007
	Item no.: 248-501/000-012 Mini-WSB marking card; as card; not stretchable; plain; snap-on type; orange	www.wago.com/248-501/000-012
	Item no.: 248-501/000-017 Mini-WSB marking card; as card; not stretchable; plain; snap-on type; light green	www.wago.com/248-501/000-017

Subject to changes. Please also observe the further product documentation!



Item no.: 248-501/000-023
Mini-WSB marking card; as card; not stretchable; plain; snap-on type; green

www.wago.com/248-501/000-023

Item no.: 248-501/000-024
Mini-WSB marking card; as card; not stretchable; plain; snap-on type; violet

www.wago.com/248-501/000-024

Coding



Item no.: 769-435
Coding pin; for coding of female plugs; for carrier terminal blocks / male connectors; orange

www.wago.com/769-435

tools



Item no.: 210-720
Operating tool; Blade: 3.5 x 0.5 mm; with a partially insulated shaft

www.wago.com/210-720

Female plug



Item no.: 769-101
1-conductor female plug; 4 mm²; 1-pole; 4,00 mm²; gray

www.wago.com/769-101



Item no.: 769-101/000-006
1-conductor female plug; 4 mm²; 1-pole; 4,00 mm²; blue

www.wago.com/769-101/000-006

Item no.: 769-101/000-016
1-conductor female plug; 4 mm²; 1-pole; 4,00 mm²; green-yellow

www.wago.com/769-101/000-016



Item no.: 769-101/022-000
1-conductor female plug; angled; 4 mm²; 1-pole; 4,00 mm²; gray

www.wago.com/769-101/022-000



Item no.: 769-101/022-016
1-conductor female plug; angled; 4 mm²; 1-pole; 4,00 mm²; green-yellow

www.wago.com/769-101/022-016



Item no.: 769-102
1-conductor female plug; 4 mm²; 2-pole; 4,00 mm²; gray

www.wago.com/769-102



Item no.: 769-102/000-006
1-conductor female plug; 4 mm²; 2-pole; 4,00 mm²; blue

www.wago.com/769-102/000-006



Item no.: 769-102/000-036
1-conductor female plug; 4 mm²; 2-pole; 4,00 mm²; gray, green-yellow

www.wago.com/769-102/000-036



Item no.: 769-102/000-037
1-conductor female plug; 4 mm²; 2-pole; 4,00 mm²; green-yellow, gray

www.wago.com/769-102/000-037

Subject to changes. Please also observe the further product documentation!



Item no.: 769-102/022-000
1-conductor female plug; angled; 4 mm²; 2-pole; 4,00 mm²; gray

www.wago.com/769-102/022-000



Item no.: 769-103
1-conductor female plug; 4 mm²; 3-pole; 4,00 mm²; gray

www.wago.com/769-103



Item no.: 769-103/000-006
1-conductor female plug; 4 mm²; 3-pole; 4,00 mm²; blue

www.wago.com/769-103/000-006



Item no.: 769-103/000-036
1-conductor female plug; 4 mm²; 3-pole; 4,00 mm²; gray, green-yellow

www.wago.com/769-103/000-036



Item no.: 769-103/000-037
1-conductor female plug; 4 mm²; 3-pole; 4,00 mm²; green-yellow, gray

www.wago.com/769-103/000-037

Item no.: 769-103/000-038
1-conductor female plug; 4 mm²; 3-pole; 4,00 mm²; gray, blue, green-yellow

www.wago.com/769-103/000-038



Item no.: 769-103/000-039
1-conductor female plug; 4 mm²; 3-pole; 4,00 mm²; green-yellow, blue, gray

www.wago.com/769-103/000-039

Item no.: 769-103/022-000
1-conductor female plug; angled; 4 mm²; 3-pole; 4,00 mm²; gray

www.wago.com/769-103/022-000



Item no.: 769-104
1-conductor female plug; 4 mm²; 4-pole; 4,00 mm²; gray

www.wago.com/769-104



Item no.: 769-104/000-006
1-conductor female plug; 4 mm²; 4-pole; 4,00 mm²; blue

www.wago.com/769-104/000-006

Item no.: 769-104/000-036
1-conductor female plug; 4 mm²; 4-pole; 4,00 mm²; gray, green-yellow

www.wago.com/769-104/000-036



Item no.: 769-104/000-037
1-conductor female plug; 4 mm²; 4-pole; 4,00 mm²; green-yellow, gray

www.wago.com/769-104/000-037









Item no.: 769-104/000-038
1-conductor female plug; 4 mm²; 4-pole; 4,00 mm²; gray, blue, green-yellow

www.wago.com/769-104/000-038











Item no.: 769-104/000-039
1-conductor female plug; 4 mm²; 4-pole; 4,00 mm²; green-yellow, blue, gray

www.wago.com/769-104/000-039















Subject to changes. Please also observe the further product documentation!

	<p>Item no.: 769-104/022-000 1-conductor female plug; angled; 4 mm²; 4-pole; 4,00 mm²; gray</p>	<p>www.wago.com/769-104/022-000</p>
	<p>Item no.: 769-105/000-006 1-conductor female plug; 4 mm²; 5-pole; 4,00 mm²; blue</p>	<p>www.wago.com/769-105/000-006</p>
	<p>Item no.: 769-105/000-036 1-conductor female plug; 4 mm²; 5-pole; 4,00 mm²; gray, green-yellow</p>	<p>www.wago.com/769-105/000-036</p>
	<p>Item no.: 769-105/000-037 1-conductor female plug; 4 mm²; 5-pole; 4,00 mm²; green-yellow, gray</p>	<p>www.wago.com/769-105/000-037</p>
	<p>Item no.: 769-105/000-038 1-conductor female plug; 4 mm²; 5-pole; 4,00 mm²; gray, blue, green-yellow</p>	<p>www.wago.com/769-105/000-038</p>
	<p>Item no.: 769-105/000-039 1-conductor female plug; 4 mm²; 5-pole; 4,00 mm²; green-yellow, blue, gray</p>	<p>www.wago.com/769-105/000-039</p>
	<p>Item no.: 769-106 1-conductor female plug; 4 mm²; 6-pole; 4,00 mm²; gray</p>	<p>www.wago.com/769-106</p>
	<p>Item no.: 769-106/000-006 1-conductor female plug; 4 mm²; 6-pole; 4,00 mm²; blue</p>	<p>www.wago.com/769-106/000-006</p>
	<p>Item no.: 769-106/000-036 1-conductor female plug; 4 mm²; 6-pole; 4,00 mm²; gray, green-yellow</p>	<p>www.wago.com/769-106/000-036</p>
	<p>Item no.: 769-106/000-037 1-conductor female plug; 4 mm²; 6-pole; 4,00 mm²; green-yellow, gray</p>	<p>www.wago.com/769-106/000-037</p>
	<p>Item no.: 769-106/000-038 1-conductor female plug; 4 mm²; 6-pole; 4,00 mm²; gray, blue, green-yellow</p>	<p>www.wago.com/769-106/000-038</p>
	<p>Item no.: 769-106/000-039 1-conductor female plug; 4 mm²; 6-pole; 4,00 mm²; green-yellow, blue, gray</p>	<p>www.wago.com/769-106/000-039</p>
	<p>Item no.: 769-106/022-000 1-conductor female plug; angled; 4 mm²; 6-pole; 4,00 mm²; gray</p>	<p>www.wago.com/769-106/022-000</p>
	<p>Item no.: 769-107 1-conductor female plug; 4 mm²; 7-pole; 4,00 mm²; gray</p>	<p>www.wago.com/769-107</p>















Subject to changes. Please also observe the further product documentation!

	<p>Item no.: 769-107/000-006 1-conductor female plug; 4 mm²; 7-pole; 4,00 mm²; blue</p>	<p>www.wago.com/769-107/000-006</p>
	<p>Item no.: 769-107/000-036 1-conductor female plug; 4 mm²; 7-pole; 4,00 mm²; gray, green-yellow</p>	<p>www.wago.com/769-107/000-036</p>
	<p>Item no.: 769-107/000-037 1-conductor female plug; 4 mm²; 7-pole; 4,00 mm²; green-yellow, gray</p>	<p>www.wago.com/769-107/000-037</p>
	<p>Item no.: 769-107/000-038 1-conductor female plug; 4 mm²; 7-pole; 4,00 mm²; gray, blue, green-yellow</p>	<p>www.wago.com/769-107/000-038</p>
	<p>Item no.: 769-107/000-039 1-conductor female plug; 4 mm²; 7-pole; 4,00 mm²; green-yellow, blue, gray</p>	<p>www.wago.com/769-107/000-039</p>
	<p>Item no.: 769-107/022-000 1-conductor female plug; angled; 4 mm²; 7-pole; 4,00 mm²; gray</p>	<p>www.wago.com/769-107/022-000</p>
	<p>Item no.: 769-108 1-conductor female plug; 4 mm²; 8-pole; 4,00 mm²; gray</p>	<p>www.wago.com/769-108</p>
	<p>Item no.: 769-108/000-006 1-conductor female plug; 4 mm²; 8-pole; 4,00 mm²; blue</p>	<p>www.wago.com/769-108/000-006</p>
	<p>Item no.: 769-108/000-036 1-conductor female plug; 4 mm²; 8-pole; 4,00 mm²; gray, green-yellow</p>	<p>www.wago.com/769-108/000-036</p>
	<p>Item no.: 769-108/000-037 1-conductor female plug; 4 mm²; 8-pole; 4,00 mm²; green-yellow, gray</p>	<p>www.wago.com/769-108/000-037</p>
	<p>Item no.: 769-108/000-038 1-conductor female plug; 4 mm²; 8-pole; 4,00 mm²; gray, blue, green-yellow</p>	<p>www.wago.com/769-108/000-038</p>
	<p>Item no.: 769-108/000-039 1-conductor female plug; 4 mm²; 8-pole; 4,00 mm²; green-yellow, blue, gray</p>	<p>www.wago.com/769-108/000-039</p>
	<p>Item no.: 769-108/022-000 1-conductor female plug; angled; 4 mm²; 8-pole; 4,00 mm²; gray</p>	<p>www.wago.com/769-108/022-000</p>
	<p>Item no.: 769-109 1-conductor female plug; 4 mm²; 9-pole; 4,00 mm²; gray</p>	<p>www.wago.com/769-109</p>















Subject to changes. Please also observe the further product documentation!

	<p>Item no.: 769-109/000-006 1-conductor female plug; 4 mm²; 9-pole; 4,00 mm²; blue</p>	www.wago.com/769-109/000-006
	<p>Item no.: 769-109/000-036 1-conductor female plug; 4 mm²; 9-pole; 4,00 mm²; gray, green-yellow</p>	www.wago.com/769-109/000-036
	<p>Item no.: 769-109/000-037 1-conductor female plug; 4 mm²; 9-pole; 4,00 mm²; green-yellow, gray</p>	www.wago.com/769-109/000-037
	<p>Item no.: 769-109/000-038 1-conductor female plug; 4 mm²; 9-pole; 4,00 mm²; gray, blue, green-yellow</p>	www.wago.com/769-109/000-038
	<p>Item no.: 769-109/000-039 1-conductor female plug; 4 mm²; 9-pole; 4,00 mm²; green-yellow, blue, gray</p>	www.wago.com/769-109/000-039
	<p>Item no.: 769-109/022-000 1-conductor female plug; angled; 4 mm²; 9-pole; 4,00 mm²; gray</p>	www.wago.com/769-109/022-000
	<p>Item no.: 769-110 1-conductor female plug; 4 mm²; 10-pole; 4,00 mm²; gray</p>	www.wago.com/769-110
	<p>Item no.: 769-110/000-006 1-conductor female plug; 4 mm²; 10-pole; 4,00 mm²; blue</p>	www.wago.com/769-110/000-006
	<p>Item no.: 769-110/000-036 1-conductor female plug; 4 mm²; 10-pole; 4,00 mm²; gray, green-yellow</p>	www.wago.com/769-110/000-036
	<p>Item no.: 769-110/000-037 1-conductor female plug; 4 mm²; 10-pole; 4,00 mm²; green-yellow, gray</p>	www.wago.com/769-110/000-037
	<p>Item no.: 769-110/000-038 1-conductor female plug; 4 mm²; 10-pole; 4,00 mm²; gray, blue, green-yellow</p>	www.wago.com/769-110/000-038
	<p>Item no.: 769-110/000-039 1-conductor female plug; 4 mm²; 10-pole; 4,00 mm²; green-yellow, blue, gray</p>	www.wago.com/769-110/000-039
	<p>Item no.: 769-110/022-000 1-conductor female plug; angled; 4 mm²; 10-pole; 4,00 mm²; gray</p>	www.wago.com/769-110/022-000
	<p>Item no.: 769-111 1-conductor female plug; 4 mm²; 11-pole; 4,00 mm²; gray</p>	www.wago.com/769-111

Subject to changes. Please also observe the further product documentation!

	<p>Item no.: 769-111/000-006 1-conductor female plug; 4 mm²; 11-pole; 4,00 mm²; blue</p>	www.wago.com/769-111/000-006
	<p>Item no.: 769-111/000-036 1-conductor female plug; 4 mm²; 11-pole; 4,00 mm²; gray, green-yellow</p>	www.wago.com/769-111/000-036
	<p>Item no.: 769-111/000-037 1-conductor female plug; 4 mm²; 11-pole; 4,00 mm²; green-yellow, gray</p>	www.wago.com/769-111/000-037
	<p>Item no.: 769-111/000-038 1-conductor female plug; 4 mm²; 11-pole; 4,00 mm²; gray, blue, green-yellow</p>	www.wago.com/769-111/000-038
	<p>Item no.: 769-111/000-039 1-conductor female plug; 4 mm²; 11-pole; 4,00 mm²; green-yellow, blue, gray</p>	www.wago.com/769-111/000-039
	<p>Item no.: 769-111/022-000 1-conductor female plug; angled; 4 mm²; 11-pole; 4,00 mm²; gray</p>	www.wago.com/769-111/022-000
	<p>Item no.: 769-112 1-conductor female plug; 4 mm²; 12-pole; 4,00 mm²; gray</p>	www.wago.com/769-112
	<p>Item no.: 769-112/000-006 1-conductor female plug; 4 mm²; 12-pole; 4,00 mm²; blue</p>	www.wago.com/769-112/000-006
	<p>Item no.: 769-112/000-036 1-conductor female plug; 4 mm²; 12-pole; 4,00 mm²; gray, green-yellow</p>	www.wago.com/769-112/000-036
	<p>Item no.: 769-112/000-037 1-conductor female plug; 4 mm²; 12-pole; 4,00 mm²; green-yellow, gray</p>	www.wago.com/769-112/000-037
	<p>Item no.: 769-112/000-038 1-conductor female plug; 4 mm²; 12-pole; 4,00 mm²; gray, blue, green-yellow</p>	www.wago.com/769-112/000-038
	<p>Item no.: 769-112/000-039 1-conductor female plug; 4 mm²; 12-pole; 4,00 mm²; green-yellow, blue, gray</p>	www.wago.com/769-112/000-039
	<p>Item no.: 769-112/022-000 1-conductor female plug; angled; 4 mm²; 12-pole; 4,00 mm²; gray</p>	www.wago.com/769-112/022-000
	<p>Item no.: 769-113 1-conductor female plug; 4 mm²; 13-pole; 4,00 mm²; gray</p>	www.wago.com/769-113

Subject to changes. Please also observe the further product documentation!

	<p>Item no.: 769-113/000-036 1-conductor female plug; 4 mm²; 13-pole; 4,00 mm²; gray, green-yellow</p>	www.wago.com/769-113/000-036
	<p>Item no.: 769-113/000-037 1-conductor female plug; 4 mm²; 13-pole; 4,00 mm²; green-yellow, gray</p>	www.wago.com/769-113/000-037
	<p>Item no.: 769-113/000-038 1-conductor female plug; 4 mm²; 13-pole; 4,00 mm²; gray, blue, green-yellow</p>	www.wago.com/769-113/000-038
	<p>Item no.: 769-113/000-039 1-conductor female plug; 4 mm²; 13-pole; 4,00 mm²; green-yellow, blue, gray</p>	www.wago.com/769-113/000-039
	<p>Item no.: 769-113/022-000 1-conductor female plug; angled; 4 mm²; 13-pole; 4,00 mm²; gray</p>	www.wago.com/769-113/022-000
	<p>Item no.: 769-114 1-conductor female plug; 4 mm²; 14-pole; 4,00 mm²; gray</p>	www.wago.com/769-114
	<p>Item no.: 769-114/000-006 1-conductor female plug; 4 mm²; 14-pole; 4,00 mm²; blue</p>	www.wago.com/769-114/000-006
	<p>Item no.: 769-114/000-036 1-conductor female plug; 4 mm²; 14-pole; 4,00 mm²; gray, green-yellow</p>	www.wago.com/769-114/000-036
	<p>Item no.: 769-114/000-037 1-conductor female plug; 4 mm²; 14-pole; 4,00 mm²; green-yellow, gray</p>	www.wago.com/769-114/000-037
	<p>Item no.: 769-114/000-038 1-conductor female plug; 4 mm²; 14-pole; 4,00 mm²; gray, blue, green-yellow</p>	www.wago.com/769-114/000-038
	<p>Item no.: 769-114/000-039 1-conductor female plug; 4 mm²; 14-pole; 4,00 mm²; green-yellow, blue, gray</p>	www.wago.com/769-114/000-039
	<p>Item no.: 769-114/022-000 1-conductor female plug; angled; 4 mm²; 14-pole; 4,00 mm²; gray</p>	www.wago.com/769-114/022-000
	<p>Item no.: 769-115 1-conductor female plug; 4 mm²; 15-pole; 4,00 mm²; gray</p>	www.wago.com/769-115
	<p>Item no.: 769-115/000-036 1-conductor female plug; 4 mm²; 15-pole; 4,00 mm²; gray, green-yellow</p>	www.wago.com/769-115/000-036

Subject to changes. Please also observe the further product documentation!



Item no.: 769-115/000-037
1-conductor female plug; 4 mm²; 15-pole; 4,00 mm²; green-yellow, gray

www.wago.com/769-115/000-037



Item no.: 769-115/000-038
1-conductor female plug; 4 mm²; 15-pole; 4,00 mm²; gray, blue, green-yellow

www.wago.com/769-115/000-038



Item no.: 769-115/000-039
1-conductor female plug; 4 mm²; 15-pole; 4,00 mm²; green-yellow, blue, gray

www.wago.com/769-115/000-039



Item no.: 769-115/022-000
1-conductor female plug; angled; 4 mm²; 15-pole; 4,00 mm²; gray

www.wago.com/769-115/022-000

General accessories



Item no.: 286-113
Empty component plug housing; Type 12; 25 mm wide; 10-pole; gray

www.wago.com/286-113



Item no.: 286-336/001-000
Relay module; Nominal input voltage: 24 VDC; 2 break and 2 make contacts; Red status indicator; Module width: 25 mm; gray

www.wago.com/286-336/001-000



Item no.: 286-344/004-000
Relay module; Nominal input voltage: 24 VDC; 3 break contacts and 1 make contact; Path; Red status indicator; Module width: 25 mm; gray

www.wago.com/286-344/004-000



Item no.: 286-352/004-000
Relay module; Nominal input voltage: 24 VDC; 4 make contacts; Limiting continuous current: 5 A; Path; Red status indicator; Module width: 25 mm; gray

www.wago.com/286-352/004-000



Item no.: 286-664
Current flow monitoring module; AC currents; Monitoring range: 1 A – 10 A; 1 changeover contact; light gray

www.wago.com/286-664



Item no.: 286-665
Current flow monitoring module; AC currents; Monitoring range: 1 A – 10 A; 1 changeover contact; light gray

www.wago.com/286-665



Item no.: 286-742
S0 interface power supply; Input voltage: 230 VAC; S0 interface

www.wago.com/286-742



Item no.: 286-809
Component module with diode; light gray

www.wago.com/286-809



Item no.: 286-822
Component module with LED; Red LED; with common cathode

www.wago.com/286-822



Item no.: 286-826
AND gate module with 6 inputs; light gray















www.wago.com/286-826

















Item no.: 286-841
Surge suppression module for signal technology; Nominal voltage: 220 VDC; for 2 signal paths with common surge arrester; pluggable on rail-mount terminal block, 25 mm wide; gray

www.wago.com/286-841











Subject to changes. Please also observe the further product documentation!

	Item no.: 286-842 Surge suppression module for signal technology; Nominal voltage: 230 VAC; for 2 signal paths with common surge arrester; pluggable on rail-mount terminal block, 25 mm wide; gray	www.wago.com/286-842
	Item no.: 286-843 Surge suppression module for signal technology; Nominal voltage: 115 VAC; for 2 signal paths with common surge arrester; pluggable on rail-mount terminal block, 25 mm wide; gray	www.wago.com/286-843
	Item no.: 286-844 Surge suppression module for signal technology; for 2 signal paths with common surge arrester; pluggable on rail-mount terminal block, 25 mm wide; gray	www.wago.com/286-844
	Item no.: 769-438 Pin cover; with marker slot for miniature WSB; gray	www.wago.com/769-438
	Item no.: 769-439 Pin cover; with marker slot for miniature WSB; orange	www.wago.com/769-439
	Item no.: 769-501 Start module for 1-conductor female connector; with integrated end plate; 4 mm ² ; 1-pole; 4,00 mm ² ; gray	www.wago.com/769-501
	Item no.: 769-501/000-006 Start module for 1-conductor female connector; 4 mm ² ; 1-pole; 4,00 mm ² ; blue	www.wago.com/769-501/000-006
	Item no.: 769-501/000-016 Start module for 1-conductor female connector; with integrated end plate; 4 mm ² ; 1-pole; 4,00 mm ² ; green-yellow	www.wago.com/769-501/000-016
	Item no.: 769-502 Center module for 1-conductor female connector; 4 mm ² ; 1-pole; 4,00 mm ² ; gray	www.wago.com/769-502
	Item no.: 769-502/000-006 Center module for 1-conductor female connector; 4 mm ² ; 1-pole; 4,00 mm ² ; blue	www.wago.com/769-502/000-006
	Item no.: 769-502/000-016 Center module for 1-conductor female connector; 4 mm ² ; 1-pole; 4,00 mm ² ; green-yellow	www.wago.com/769-502/000-016
	Item no.: 769-503 End module for 1-conductor female connector; 4 mm ² ; 1-pole; 4,00 mm ² ; gray	www.wago.com/769-503
	Item no.: 769-503/000-006 End module for 1-conductor female connector; 4 mm ² ; 1-pole; 4,00 mm ² ; blue	www.wago.com/769-503/000-006
	Item no.: 769-503/000-016 End module for 1-conductor female connector; 4 mm ² ; 1-pole; 4,00 mm ² ; green-yellow	www.wago.com/769-503/000-016
	Item no.: 769-512 Start module for 1-conductor female connector; angled; 4 mm ² ; 1-pole; 4,00 mm ² ; gray	www.wago.com/769-512

Subject to changes. Please also observe the further product documentation!

	Item no.: 769-512/000-006 Start module for 1-conductor female connector; angled; 4 mm ² ; 1-pole; 4,00 mm ² ; blue	www.wago.com/769-512/000-006
	Item no.: 769-512/000-016 Start module for 1-conductor female connector; angled; 4 mm ² ; 1-pole; 4,00 mm ² ; green-yellow	www.wago.com/769-512/000-016
	Item no.: 769-513 Center module for 1-conductor female connector; angled; 4 mm ² ; 1-pole; 4,00 mm ² ; gray	www.wago.com/769-513
	Item no.: 769-513/000-006 Center module for 1-conductor female connector; angled; 4 mm ² ; 1-pole; 4,00 mm ² ; blue	www.wago.com/769-513/000-006
	Item no.: 769-513/000-016 Center module for 1-conductor female connector; angled; 4 mm ² ; 1-pole; 4,00 mm ² ; green-yellow	www.wago.com/769-513/000-016
	Item no.: 769-515 End module for 1-conductor female connector; angled; 4 mm ² ; 1-pole; 4,00 mm ² ; gray	www.wago.com/769-515
	Item no.: 769-515/000-006 End module for 1-conductor female connector; angled; 4 mm ² ; 1-pole; 4,00 mm ² ; blue	www.wago.com/769-515/000-006
	Item no.: 769-515/000-016 End module for 1-conductor female connector; angled; 4 mm ² ; 1-pole; 4,00 mm ² ; green-yellow	www.wago.com/769-515/000-016
	Item no.: 786-103 Empty component plug housing; Type 16; 25 mm wide; 10-pole; gray	www.wago.com/786-103
Jumper		
	Item no.: 249-123 Push-in type wire jumper; insulated; wire length 180 mm; Conductor cross section 0.75 mm ²	www.wago.com/249-123
	Item no.: 249-125 Push-in type wire jumper; insulated; wire length 60 mm; Conductor cross section 0.75 mm ²	www.wago.com/249-125
	Item no.: 249-126 Push-in type wire jumper; insulated; wire length 110 mm; Conductor cross section 0.75 mm ²	www.wago.com/249-126
	Item no.: 249-127 Push-in type wire jumper; insulated; wire length 250 mm; Conductor cross section 0.75 mm ²	www.wago.com/249-127
	Item no.: 280-402 Adjacent jumper; insulated; IN = IN terminal block; gray	www.wago.com/280-402
	Item no.: 280-409 Alternate jumper; insulated; IN = IN terminal block; gray	www.wago.com/280-409
	Item no.: 780-452 Staggered jumper; insulated; from 1 to 2; Spacing: 5 mm; suitable for 2-conductor female plugs; gray	www.wago.com/780-452

Subject to changes. Please also observe the further product documentation!

	Item no.: 780-453 Staggered jumper; insulated; from 1 to 3; Spacing: 5 mm; suitable for 2-conductor female plugs; gray	www.wago.com/780-453
	Item no.: 780-454 Staggered jumper; insulated; from 1 to 4; Spacing: 5 mm; suitable for 2-conductor female plugs; gray	www.wago.com/780-454
	Item no.: 780-455 Staggered jumper; insulated; from 1 to 5; Spacing: 5 mm; suitable for 2-conductor female plugs; gray	www.wago.com/780-455
	Item no.: 780-456 Staggered jumper; insulated; from 1 to 6; Spacing: 5 mm; suitable for 2-conductor female plugs; gray	www.wago.com/780-456
	Item no.: 780-457 Staggered jumper; insulated; from 1 to 7; Spacing: 5 mm; suitable for 2-conductor female plugs; gray	www.wago.com/780-457
	Item no.: 780-458 Staggered jumper; insulated; from 1 to 8; Spacing: 5 mm; suitable for 2-conductor female plugs; gray	www.wago.com/780-458
assembling		
	Item no.: 209-106 Mounting carrier; for isolated mounting on DIN 35 rails; gray	www.wago.com/209-106
Test Accessories		
	Item no.: 210-137 Test plug; 2.3 mm Ø; with 500 mm cable; yellow	www.wago.com/210-137
	Item no.: 280-404 Test plug adapter; 5 mm wide; for test plug 210-137 (2.3 mm Ø); suitable for 1.5 mm ² - 4 mm ² tbs; gray	www.wago.com/280-404
	Item no.: 280-418 Test plug module; modular; suitable for all WAGO 280 and 780 Series rail-mounted terminal blocks with jumper slots in the current bar; gray	www.wago.com/280-418
	Item no.: 280-419 Spacer module; modular; bridging commoned terminal blocks; gray	www.wago.com/280-419
End plate		
	Item no.: 769-309 End and intermediate plate; 1.1 mm thick; gray	www.wago.com/769-309
	Item no.: 769-310 End and intermediate plate; 1.1 mm thick; orange	www.wago.com/769-310
	Item no.: 769-313 Separator plate; 1.1 mm thick; oversized; orange	www.wago.com/769-313

Downloads

Documentation

Additional Information

Technical explanations	Apr 3, 2019	pdf	Download
------------------------	-------------	-----	----------

Subject to changes. Please also observe the further product documentation!

CAD/CAE-Data

CAD data

2D/3D Models 769-165/769-313

[URL](#)

[Download](#)

CAE data

EPLAN Data Portal 769-165/769-313

[URL](#)

[Download](#)

WSCAD Universe 769-165/769-313

[URL](#)

[Download](#)

Installation Notes

Assembly

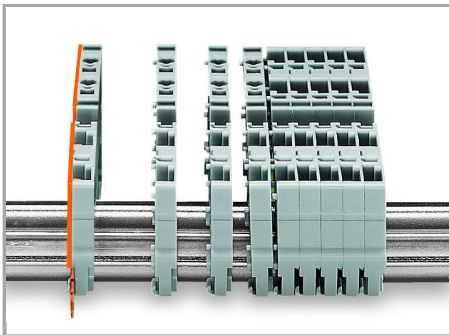

Snap individual carrier terminal blocks onto the carrier rail and slide together.

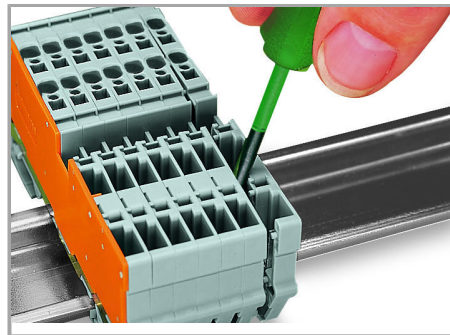

Open the assembly by laterally sliding a block via operating tool and remove terminal block via release lever.

Jumpered

Subject to changes. Please also observe the further product documentation!

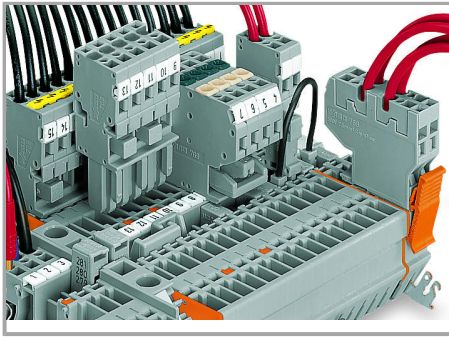

Commoning with adjacent or staggered jumpers –

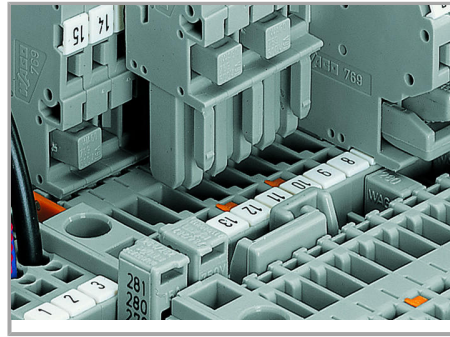

Commoning carrier terminal blocks via staggered jumpers.

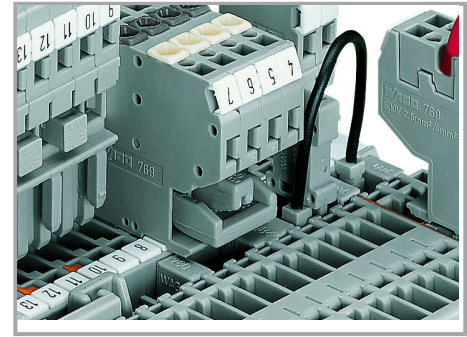

Commoning a 2-conductor female plug via staggered jumper and carrier terminal blocks via adjacent jumpers.

push jumpers down until fully inserted.

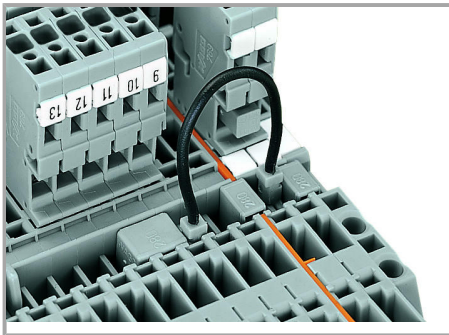

Commoning carrier terminal blocks via push-in type wire jumpers or adjacent jumpers – even over an intermediate plate.

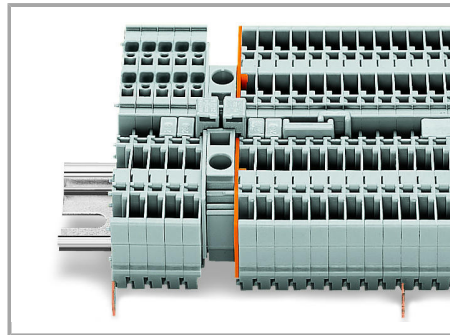

Commoning "supply terminal blocks" (up to 10 mm²/8 AWG) with carrier terminal blocks via step-down jumpers.

Testing

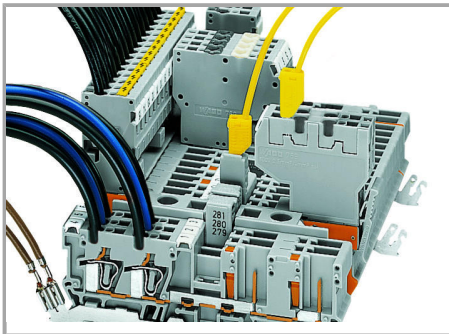

Testing via 2 or 2.3 mm Ø test plugs.

Subject to changes. Please also observe the further product documentation!

Coding

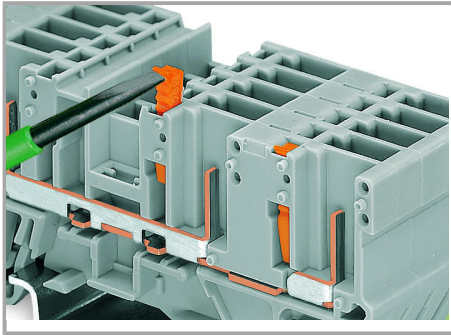

Snap coding pin in proper direction on carrier terminal block.

Shown: Coding pin removal from carrier terminal block.

Locking

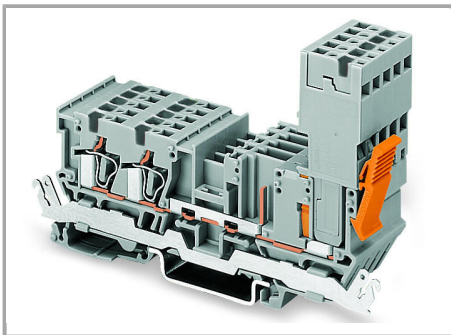

Female plug secured with locking lever on the terminal block side.

Subject to changes. Please also observe the further product documentation!

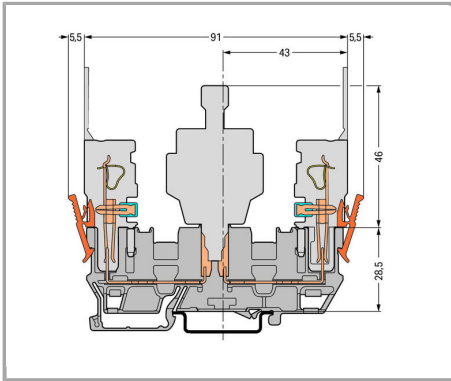

Carrier terminal block

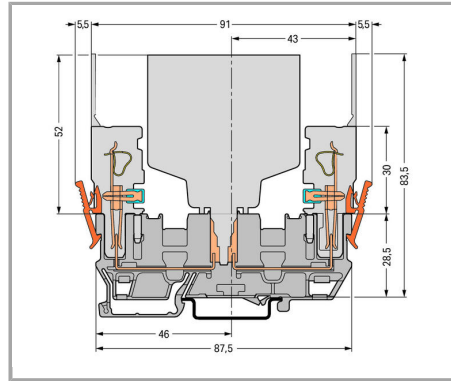

Carrier terminal block

For other dimensions, see 769-151 Carrier Terminal Block.

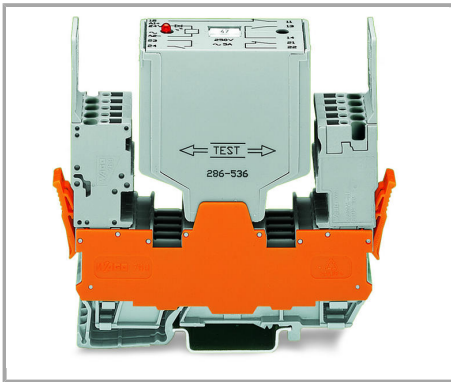

2-pin carrier terminal block for pluggable modules with orange separator plate

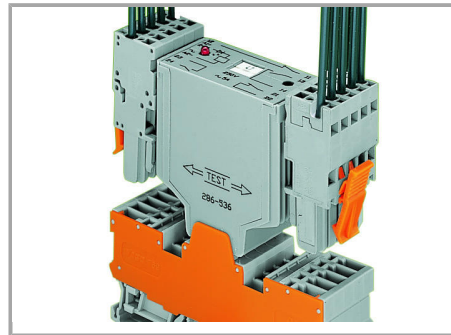

2-pin terminal block for pluggable modules with two jumper positions and separator plate

1-connector female plug, straight*

Relay plug, 25 mm wide

*1-conductor angled female plug is also possible!

Product family

Subject to changes. Please also observe the further product documentation!



X-COM

[Learn more about the product family.](#)

[Show all products from the family](#)

Subject to changes. Please also observe the further product documentation!

WAGO Kontakttechnik GmbH & Co. KG
Hansastr. 27
32423 Minden
Phone: +49571 887-0 | Fax: +49571 887-169
Email: info.de@wago.com | Web: www.wago.com

Do you have any questions about our products?
We are always happy to take your call at +49 (571) 887-44222.