

Data sheet | Item number: 769-164/769-313

2-pin terminal block for pluggable modules; 8-pole; with 2 jumper positions; with orange separator plate; for DIN-rail 35 x 15 and 35 x 7.5; gray

www.wago.com/769-164/769-313

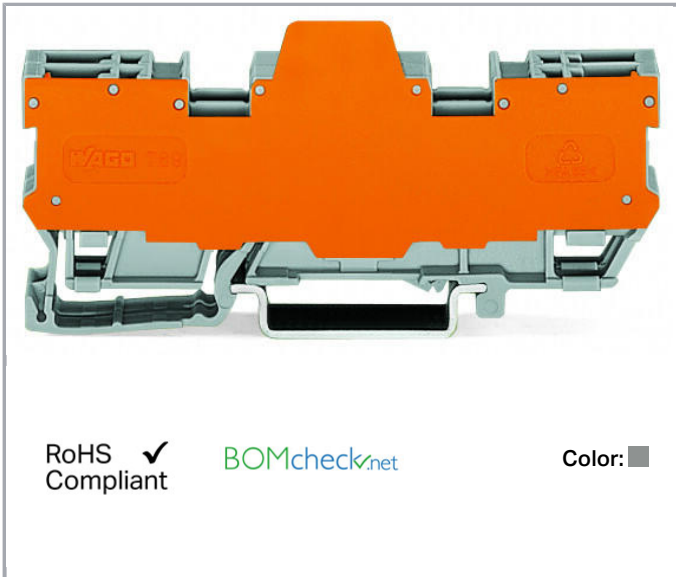

Data

Electrical data

Ratings per IEC/EN 60664-1

Rated voltage (III / 3)	400 V
Rated impulse voltage (III / 3)	6 kV
Rated current	16 A
Legend (ratings)	(III / 3) $\hat{=}$ Overvoltage category III / Pollution degree 3

Connection data

No. of poles	8
Total number of potentials	8
Number of levels	1
Type of wiring	Front-entry wiring

Geometrical Data

Width	21.1 mm / 0.831 inch
Height from upper-edge of DIN-35 rail	28.5 mm / 1.122 inch

Subject to changes. Please also observe the further product documentation!

WAGO Kontakttechnik GmbH & Co. KG
Hansastr. 27
32423 Minden
Phone: +49571 887-0 | Fax: +49571 887-169
Email: info.de@wago.com | Web: www.wago.com

Do you have any questions about our products?
We are always happy to take your call at +49 (571) 887-44222.

Depth	87.5 mm / 3.445 inch
-------	----------------------

Mechanical data

Design	horizontal
Type of mounting	DIN-35 rail
Marking level	Center marking

Material Data



Color	gray
Insulating material	Polyamide 66 (PA 66)
Fire load	0.736 MJ
Weight	33.1 g

Commercial data

Product Group	18 (X-COM-System)
Packaging type	BOX
Country of origin	DE
GTIN	4044918630207
Customs Tariff No.	85369010000

Approvals / Certificates



Country specific Approvals

Logo	Approval	Additional Approval Text	Certificate name
	CCA DEKRA Certification B.V.	EN 60947	NTR NL-7626
	CSA DEKRA Certification B.V.	C22.2 No. 158	1101144
	KEMA/KEUR DEKRA Certification B.V.	EN 60947	2190419.01



Ship Approvals

Certificate

Subject to changes. Please also observe the further product documentation!

Logo	Approval	Additional Approval Text	name
	ABS American Bureau of Shipping	EN 60947	20- HG1941090- PDA
	DNV GL Det Norske Veritas, Germanischer Lloyd	-	TAE00001V2

UL-Approvals

Logo	Approval	Additional Approval Text	Certificate name
	UR Underwriters Laboratories Inc.	UL 1059	20190731- E45172
	UR Underwriters Laboratories Inc.	UL 1977	20151210- E45171

Counterpart



Item no.769-104

1-conductor female plug; 4 mm²; 4-pole; 4,00 mm²; gray

www.wago.com/769-104



Item no.769-104/022-000











1-conductor female plug; angled; 4 mm²; 4-pole; 4,00 mm²; gray

www.wago.com/769-104/022-000

Compatible products

Subject to changes. Please also observe the further product documentation!

Female plug

	Item no.: 769-101 1-conductor female plug; 4 mm ² ; 1-pole; 4,00 mm ² ; gray	www.wago.com/769-101
	Item no.: 769-101/000-006 1-conductor female plug; 4 mm ² ; 1-pole; 4,00 mm ² ; blue	www.wago.com/769-101/000-006
	Item no.: 769-101/000-016 1-conductor female plug; 4 mm ² ; 1-pole; 4,00 mm ² ; green-yellow	www.wago.com/769-101/000-016
	Item no.: 769-101/022-000 1-conductor female plug; angled; 4 mm ² ; 1-pole; 4,00 mm ² ; gray	www.wago.com/769-101/022-000
	Item no.: 769-101/022-016 1-conductor female plug; angled; 4 mm ² ; 1-pole; 4,00 mm ² ; green-yellow	www.wago.com/769-101/022-016
	Item no.: 769-102 1-conductor female plug; 4 mm ² ; 2-pole; 4,00 mm ² ; gray	www.wago.com/769-102
	Item no.: 769-102/000-006 1-conductor female plug; 4 mm ² ; 2-pole; 4,00 mm ² ; blue	www.wago.com/769-102/000-006
	Item no.: 769-102/000-036 1-conductor female plug; 4 mm ² ; 2-pole; 4,00 mm ² ; gray, green-yellow	www.wago.com/769-102/000-036
	Item no.: 769-102/000-037 1-conductor female plug; 4 mm ² ; 2-pole; 4,00 mm ² ; green-yellow, gray	www.wago.com/769-102/000-037
	Item no.: 769-102/022-000 1-conductor female plug; angled; 4 mm ² ; 2-pole; 4,00 mm ² ; gray	www.wago.com/769-102/022-000
	Item no.: 769-103 1-conductor female plug; 4 mm ² ; 3-pole; 4,00 mm ² ; gray	www.wago.com/769-103
	Item no.: 769-103/000-006 1-conductor female plug; 4 mm ² ; 3-pole; 4,00 mm ² ; blue	www.wago.com/769-103/000-006

Subject to changes. Please also observe the further product documentation!



Item no.: 769-103/000-036
1-conductor female plug; 4 mm²; 3-pole; 4,00 mm²; gray, green-yellow

www.wago.com/769-103/000-036



Item no.: 769-103/000-037
1-conductor female plug; 4 mm²; 3-pole; 4,00 mm²; green-yellow, gray

www.wago.com/769-103/000-037

Item no.: 769-103/000-038
1-conductor female plug; 4 mm²; 3-pole; 4,00 mm²; gray, blue, green-yellow

www.wago.com/769-103/000-038



Item no.: 769-103/000-039
1-conductor female plug; 4 mm²; 3-pole; 4,00 mm²; green-yellow, blue, gray

www.wago.com/769-103/000-039

Item no.: 769-103/022-000
1-conductor female plug; angled; 4 mm²; 3-pole; 4,00 mm²; gray

www.wago.com/769-103/022-000



Item no.: 769-104/000-006
1-conductor female plug; 4 mm²; 4-pole; 4,00 mm²; blue

www.wago.com/769-104/000-006

Item no.: 769-104/000-036
1-conductor female plug; 4 mm²; 4-pole; 4,00 mm²; gray, green-yellow

www.wago.com/769-104/000-036



Item no.: 769-104/000-037
1-conductor female plug; 4 mm²; 4-pole; 4,00 mm²; green-yellow, gray

www.wago.com/769-104/000-037

Item no.: 769-104/000-038
1-conductor female plug; 4 mm²; 4-pole; 4,00 mm²; gray, blue, green-yellow

www.wago.com/769-104/000-038

Item no.: 769-104/000-039
1-conductor female plug; 4 mm²; 4-pole; 4,00 mm²; green-yellow, blue, gray

www.wago.com/769-104/000-039



Item no.: 769-105
1-conductor female plug; 4 mm²; 5-pole; 4,00 mm²; gray

www.wago.com/769-105



Item no.: 769-105/000-006
1-conductor female plug; 4 mm²; 5-pole; 4,00 mm²; blue

www.wago.com/769-105/000-006













Item no.: 769-105/000-036
1-conductor female plug; 4 mm²; 5-pole; 4,00 mm²; gray, green-yellow

www.wago.com/769-105/000-036











Item no.: 769-105/000-037
1-conductor female plug; 4 mm²; 5-pole; 4,00 mm²; green-yellow, gray

www.wago.com/769-105/000-037















Subject to changes. Please also observe the further product documentation!

	<p>Item no.: 769-105/000-038 1-conductor female plug; 4 mm²; 5-pole; 4,00 mm²; gray, blue, green-yellow</p>	www.wago.com/769-105/000-038
	<p>Item no.: 769-105/000-039 1-conductor female plug; 4 mm²; 5-pole; 4,00 mm²; green-yellow, blue, gray</p>	www.wago.com/769-105/000-039
	<p>Item no.: 769-105/022-000 1-conductor female plug; angled; 4 mm²; 5-pole; 4,00 mm²; gray</p>	www.wago.com/769-105/022-000
	<p>Item no.: 769-106 1-conductor female plug; 4 mm²; 6-pole; 4,00 mm²; gray</p>	www.wago.com/769-106
	<p>Item no.: 769-106/000-006 1-conductor female plug; 4 mm²; 6-pole; 4,00 mm²; blue</p>	www.wago.com/769-106/000-006
	<p>Item no.: 769-106/000-036 1-conductor female plug; 4 mm²; 6-pole; 4,00 mm²; gray, green-yellow</p>	www.wago.com/769-106/000-036
	<p>Item no.: 769-106/000-037 1-conductor female plug; 4 mm²; 6-pole; 4,00 mm²; green-yellow, gray</p>	www.wago.com/769-106/000-037
	<p>Item no.: 769-106/000-038 1-conductor female plug; 4 mm²; 6-pole; 4,00 mm²; gray, blue, green-yellow</p>	www.wago.com/769-106/000-038
	<p>Item no.: 769-106/000-039 1-conductor female plug; 4 mm²; 6-pole; 4,00 mm²; green-yellow, blue, gray</p>	www.wago.com/769-106/000-039
	<p>Item no.: 769-106/022-000 1-conductor female plug; angled; 4 mm²; 6-pole; 4,00 mm²; gray</p>	www.wago.com/769-106/022-000
	<p>Item no.: 769-107 1-conductor female plug; 4 mm²; 7-pole; 4,00 mm²; gray</p>	www.wago.com/769-107
	<p>Item no.: 769-107/000-006 1-conductor female plug; 4 mm²; 7-pole; 4,00 mm²; blue</p>	www.wago.com/769-107/000-006
	<p>Item no.: 769-107/000-036 1-conductor female plug; 4 mm²; 7-pole; 4,00 mm²; gray, green-yellow</p>	www.wago.com/769-107/000-036
	<p>Item no.: 769-107/000-037 1-conductor female plug; 4 mm²; 7-pole; 4,00 mm²; green-yellow, gray</p>	www.wago.com/769-107/000-037















Subject to changes. Please also observe the further product documentation!

	<p>Item no.: 769-107/000-038 1-conductor female plug; 4 mm²; 7-pole; 4,00 mm²; gray, blue, green-yellow</p>	<p>www.wago.com/769-107/000-038</p>
	<p>Item no.: 769-107/000-039 1-conductor female plug; 4 mm²; 7-pole; 4,00 mm²; green-yellow, blue, gray</p>	<p>www.wago.com/769-107/000-039</p>
	<p>Item no.: 769-107/022-000 1-conductor female plug; angled; 4 mm²; 7-pole; 4,00 mm²; gray</p>	<p>www.wago.com/769-107/022-000</p>
	<p>Item no.: 769-108 1-conductor female plug; 4 mm²; 8-pole; 4,00 mm²; gray</p>	<p>www.wago.com/769-108</p>
	<p>Item no.: 769-108/000-006 1-conductor female plug; 4 mm²; 8-pole; 4,00 mm²; blue</p>	<p>www.wago.com/769-108/000-006</p>
	<p>Item no.: 769-108/000-036 1-conductor female plug; 4 mm²; 8-pole; 4,00 mm²; gray, green-yellow</p>	<p>www.wago.com/769-108/000-036</p>
	<p>Item no.: 769-108/000-037 1-conductor female plug; 4 mm²; 8-pole; 4,00 mm²; green-yellow, gray</p>	<p>www.wago.com/769-108/000-037</p>
	<p>Item no.: 769-108/000-038 1-conductor female plug; 4 mm²; 8-pole; 4,00 mm²; gray, blue, green-yellow</p>	<p>www.wago.com/769-108/000-038</p>
	<p>Item no.: 769-108/000-039 1-conductor female plug; 4 mm²; 8-pole; 4,00 mm²; green-yellow, blue, gray</p>	<p>www.wago.com/769-108/000-039</p>
	<p>Item no.: 769-108/022-000 1-conductor female plug; angled; 4 mm²; 8-pole; 4,00 mm²; gray</p>	<p>www.wago.com/769-108/022-000</p>
	<p>Item no.: 769-109 1-conductor female plug; 4 mm²; 9-pole; 4,00 mm²; gray</p>	<p>www.wago.com/769-109</p>
	<p>Item no.: 769-109/000-006 1-conductor female plug; 4 mm²; 9-pole; 4,00 mm²; blue</p>	<p>www.wago.com/769-109/000-006</p>
	<p>Item no.: 769-109/000-036 1-conductor female plug; 4 mm²; 9-pole; 4,00 mm²; gray, green-yellow</p>	<p>www.wago.com/769-109/000-036</p>
	<p>Item no.: 769-109/000-037 1-conductor female plug; 4 mm²; 9-pole; 4,00 mm²; green-yellow, gray</p>	<p>www.wago.com/769-109/000-037</p>















Subject to changes. Please also observe the further product documentation!

	<p>Item no.: 769-109/000-038 1-conductor female plug; 4 mm²; 9-pole; 4,00 mm²; gray, blue, green-yellow</p>	www.wago.com/769-109/000-038
	<p>Item no.: 769-109/000-039 1-conductor female plug; 4 mm²; 9-pole; 4,00 mm²; green-yellow, blue, gray</p>	www.wago.com/769-109/000-039
	<p>Item no.: 769-109/022-000 1-conductor female plug; angled; 4 mm²; 9-pole; 4,00 mm²; gray</p>	www.wago.com/769-109/022-000
	<p>Item no.: 769-110 1-conductor female plug; 4 mm²; 10-pole; 4,00 mm²; gray</p>	www.wago.com/769-110
	<p>Item no.: 769-110/000-006 1-conductor female plug; 4 mm²; 10-pole; 4,00 mm²; blue</p>	www.wago.com/769-110/000-006
	<p>Item no.: 769-110/000-036 1-conductor female plug; 4 mm²; 10-pole; 4,00 mm²; gray, green-yellow</p>	www.wago.com/769-110/000-036
	<p>Item no.: 769-110/000-037 1-conductor female plug; 4 mm²; 10-pole; 4,00 mm²; green-yellow, gray</p>	www.wago.com/769-110/000-037
	<p>Item no.: 769-110/000-038 1-conductor female plug; 4 mm²; 10-pole; 4,00 mm²; gray, blue, green-yellow</p>	www.wago.com/769-110/000-038
	<p>Item no.: 769-110/000-039 1-conductor female plug; 4 mm²; 10-pole; 4,00 mm²; green-yellow, blue, gray</p>	www.wago.com/769-110/000-039
	<p>Item no.: 769-110/022-000 1-conductor female plug; angled; 4 mm²; 10-pole; 4,00 mm²; gray</p>	www.wago.com/769-110/022-000
	<p>Item no.: 769-111 1-conductor female plug; 4 mm²; 11-pole; 4,00 mm²; gray</p>	www.wago.com/769-111
	<p>Item no.: 769-111/000-006 1-conductor female plug; 4 mm²; 11-pole; 4,00 mm²; blue</p>	www.wago.com/769-111/000-006
	<p>Item no.: 769-111/000-036 1-conductor female plug; 4 mm²; 11-pole; 4,00 mm²; gray, green-yellow</p>	www.wago.com/769-111/000-036
	<p>Item no.: 769-111/000-037 1-conductor female plug; 4 mm²; 11-pole; 4,00 mm²; green-yellow, gray</p>	www.wago.com/769-111/000-037

Subject to changes. Please also observe the further product documentation!

	<p>Item no.: 769-111/000-038 1-conductor female plug; 4 mm²; 11-pole; 4,00 mm²; gray, blue, green-yellow</p>	www.wago.com/769-111/000-038
	<p>Item no.: 769-111/000-039 1-conductor female plug; 4 mm²; 11-pole; 4,00 mm²; green-yellow, blue, gray</p>	www.wago.com/769-111/000-039
	<p>Item no.: 769-111/022-000 1-conductor female plug; angled; 4 mm²; 11-pole; 4,00 mm²; gray</p>	www.wago.com/769-111/022-000
	<p>Item no.: 769-112 1-conductor female plug; 4 mm²; 12-pole; 4,00 mm²; gray</p>	www.wago.com/769-112
	<p>Item no.: 769-112/000-006 1-conductor female plug; 4 mm²; 12-pole; 4,00 mm²; blue</p>	www.wago.com/769-112/000-006
	<p>Item no.: 769-112/000-036 1-conductor female plug; 4 mm²; 12-pole; 4,00 mm²; gray, green-yellow</p>	www.wago.com/769-112/000-036
	<p>Item no.: 769-112/000-037 1-conductor female plug; 4 mm²; 12-pole; 4,00 mm²; green-yellow, gray</p>	www.wago.com/769-112/000-037
	<p>Item no.: 769-112/000-038 1-conductor female plug; 4 mm²; 12-pole; 4,00 mm²; gray, blue, green-yellow</p>	www.wago.com/769-112/000-038
	<p>Item no.: 769-112/000-039 1-conductor female plug; 4 mm²; 12-pole; 4,00 mm²; green-yellow, blue, gray</p>	www.wago.com/769-112/000-039
	<p>Item no.: 769-112/022-000 1-conductor female plug; angled; 4 mm²; 12-pole; 4,00 mm²; gray</p>	www.wago.com/769-112/022-000
	<p>Item no.: 769-113 1-conductor female plug; 4 mm²; 13-pole; 4,00 mm²; gray</p>	www.wago.com/769-113
	<p>Item no.: 769-113/000-036 1-conductor female plug; 4 mm²; 13-pole; 4,00 mm²; gray, green-yellow</p>	www.wago.com/769-113/000-036
	<p>Item no.: 769-113/000-037 1-conductor female plug; 4 mm²; 13-pole; 4,00 mm²; green-yellow, gray</p>	www.wago.com/769-113/000-037
	<p>Item no.: 769-113/000-038 1-conductor female plug; 4 mm²; 13-pole; 4,00 mm²; gray, blue, green-yellow</p>	www.wago.com/769-113/000-038

Subject to changes. Please also observe the further product documentation!

	Item no.: 769-113/000-039 1-conductor female plug; 4 mm ² ; 13-pole; 4,00 mm ² ; green-yellow, blue, gray	www.wago.com/769-113/000-039
	Item no.: 769-113/022-000 1-conductor female plug; angled; 4 mm ² ; 13-pole; 4,00 mm ² ; gray	www.wago.com/769-113/022-000
	Item no.: 769-114 1-conductor female plug; 4 mm ² ; 14-pole; 4,00 mm ² ; gray	www.wago.com/769-114
	Item no.: 769-114/000-006 1-conductor female plug; 4 mm ² ; 14-pole; 4,00 mm ² ; blue	www.wago.com/769-114/000-006
	Item no.: 769-114/000-036 1-conductor female plug; 4 mm ² ; 14-pole; 4,00 mm ² ; gray, green-yellow	www.wago.com/769-114/000-036
	Item no.: 769-114/000-037 1-conductor female plug; 4 mm ² ; 14-pole; 4,00 mm ² ; green-yellow, gray	www.wago.com/769-114/000-037
	Item no.: 769-114/000-038 1-conductor female plug; 4 mm ² ; 14-pole; 4,00 mm ² ; gray, blue, green-yellow	www.wago.com/769-114/000-038
	Item no.: 769-114/000-039 1-conductor female plug; 4 mm ² ; 14-pole; 4,00 mm ² ; green-yellow, blue, gray	www.wago.com/769-114/000-039
	Item no.: 769-114/022-000 1-conductor female plug; angled; 4 mm ² ; 14-pole; 4,00 mm ² ; gray	www.wago.com/769-114/022-000
	Item no.: 769-115 1-conductor female plug; 4 mm ² ; 15-pole; 4,00 mm ² ; gray	www.wago.com/769-115
	Item no.: 769-115/000-036 1-conductor female plug; 4 mm ² ; 15-pole; 4,00 mm ² ; gray, green-yellow	www.wago.com/769-115/000-036
	Item no.: 769-115/000-037 1-conductor female plug; 4 mm ² ; 15-pole; 4,00 mm ² ; green-yellow, gray	www.wago.com/769-115/000-037
	Item no.: 769-115/000-038 1-conductor female plug; 4 mm ² ; 15-pole; 4,00 mm ² ; gray, blue, green-yellow	www.wago.com/769-115/000-038
	Item no.: 769-115/000-039 1-conductor female plug; 4 mm ² ; 15-pole; 4,00 mm ² ; green-yellow, blue, gray	www.wago.com/769-115/000-039

Subject to changes. Please also observe the further product documentation!



Item no.: 769-115/022-000
1-conductor female plug; angled; 4 mm²; 15-pole; 4,00 mm²; gray

www.wago.com/769-115/022-000

Marking accessories

Item no.: 2009-145
Mini-WSB Inline; for Smart Printer; 1700 pieces on roll; stretchable 5 - 5.2 mm; plain; snap-on type; white www.wago.com/2009-145

Item no.: 2009-145/000-002
Mini-WSB Inline; for Smart Printer; 1700 pieces on roll; stretchable 5 - 5.2 mm; plain; snap-on type; white www.wago.com/2009-145/000-002

Item no.: 2009-145/000-005
Mini-WSB Inline; for Smart Printer; 1700 pieces on roll; stretchable 5 - 5.2 mm; plain; snap-on type; red www.wago.com/2009-145/000-005

Item no.: 2009-145/000-006
Mini-WSB Inline; for Smart Printer; 1700 pieces on roll; stretchable 5 - 5.2 mm; plain; snap-on type; blue www.wago.com/2009-145/000-006

Item no.: 2009-145/000-007
Mini-WSB Inline; for Smart Printer; 1700 pieces on roll; stretchable 5 - 5.2 mm; plain; snap-on type; white www.wago.com/2009-145/000-007

Item no.: 2009-145/000-012
Mini-WSB Inline; for Smart Printer; 1700 pieces on roll; stretchable 5 - 5.2 mm; plain; snap-on type; orange www.wago.com/2009-145/000-012

Item no.: 2009-145/000-023
Mini-WSB Inline; for Smart Printer; 1700 pieces on roll; stretchable 5 - 5.2 mm; plain; snap-on type; green www.wago.com/2009-145/000-023

Item no.: 2009-145/000-024
Mini-WSB Inline; for Smart Printer; 1700 pieces on roll; stretchable 5 - 5.2 mm; plain; snap-on type; violet www.wago.com/2009-145/000-024



Item no.: 248-501
Miniature WSB Quick marking system; plain; Marker width 5 mm; 10 strips with 10 markers per card www.wago.com/248-501



Item no.: 248-501/000-002
Mini-WSB marking card; as card; not stretchable; plain; snap-on type; yellow www.wago.com/248-501/000-002



Item no.: 248-501/000-005
Mini-WSB marking card; as card; not stretchable; plain; snap-on type; red www.wago.com/248-501/000-005



Item no.: 248-501/000-006
Mini-WSB marking card; as card; not stretchable; plain; snap-on type; blue www.wago.com/248-501/000-006

Subject to changes. Please also observe the further product documentation!

Item no.: 248-501/000-007

Mini-WSB marking card; as card; not stretchable; plain; snap-on type; gray

www.wago.com/248-501/000-007

Item no.: 248-501/000-012

Mini-WSB marking card; as card; not stretchable; plain; snap-on type; orange

www.wago.com/248-501/000-012

Item no.: 248-501/000-017

Mini-WSB marking card; as card; not stretchable; plain; snap-on type; light green

www.wago.com/248-501/000-017



Item no.: 248-501/000-023

Mini-WSB marking card; as card; not stretchable; plain; snap-on type; green

www.wago.com/248-501/000-023

Item no.: 248-501/000-024

Mini-WSB marking card; as card; not stretchable; plain; snap-on type; violet

www.wago.com/248-501/000-024

General accessories



Item no.: 286-112

Empty component plug housing; Type 11; 20 mm wide; 8-pole; gray

www.wago.com/286-112



Item no.: 286-113

Empty component plug housing; Type 12; 25 mm wide; 10-pole; gray

www.wago.com/286-113



Item no.: 286-312

Relay module; Relay with 2 changeover contacts (2u); gray

www.wago.com/286-312



Item no.: 286-312/004-000

Relay module; Nominal input voltage: 24 VDC; 2 changeover contacts; Limiting continuous current: 5 A; Path; Red status indicator; Module width: 20 mm; gray

www.wago.com/286-312/004-000



Item no.: 286-316

Relay module; Nominal input voltage: 220 VDC; 2 changeover contacts; Limiting continuous current: 7 A; Red status indicator; Module width: 20 mm; gray

www.wago.com/286-316



Item no.: 286-320

Relay module; Nominal input voltage: 24 VDC; 1 break and 1 make contact; Limiting continuous current: 6 A; Red status indicator; Module width: 20 mm; gray

www.wago.com/286-320



Item no.: 286-320/004-000

Relay module; Nominal input voltage: 24 VDC; 1 break and 1 make contact; Path; Red status indicator; Module width: 20 mm; gray

www.wago.com/286-320/004-000



Item no.: 286-328

Relay module; Nominal input voltage: 24 VDC; 2 make contact; Limiting continuous current: 6 A; Red status indicator; Module width: 20 mm; gray

www.wago.com/286-328



Item no.: 286-328/004-000

Relay module; Nominal input voltage: 24 VDC; 2 make contact; Limiting continuous current: 6 A; Path; Red status indicator; Module width: 20 mm; gray

www.wago.com/286-328/004-000

Item no.: 286-336/001-000

Subject to changes. Please also observe the further product documentation!

WAGO Kontakttechnik GmbH & Co. KG

Hansastr. 27

















32423 Minden

Phone: +49571 887-0 | Fax: +49571 887-169

















Email: info.de@wago.com | Web: www.wago.com

Do you have any questions about our products?















We are always happy to take your call at +49 (571) 887-44222.

	Relay module; Nominal input voltage: 24 VDC; 2 break and 2 make contacts; Red status indicator; Module width: 25 mm; gray	www.wago.com/286-336/001-000
	Item no.: 286-344/004-000 Relay module; Nominal input voltage: 24 VDC; 3 break contacts and 1 make contact; Path; Red status indicator; Module width: 25 mm; gray	www.wago.com/286-344/004-000
	Item no.: 286-352/004-000 Relay module; Nominal input voltage: 24 VDC; 4 make contacts; Limiting continuous current: 5 A; Path; Red status indicator; Module width: 25 mm; gray	www.wago.com/286-352/004-000
	Item no.: 286-427 Timer relay module; Nominal input voltage: 24 VDC; Limiting continuous current: 5 A; Pulse lengthening: 1 ... 10 s; Red status indicator; Module width: 20 mm; gray	www.wago.com/286-427
	Item no.: 286-516 Relay module; Nominal input voltage: 230 VAC; 2 changeover contacts; Limiting continuous current: 7 A; Red status indicator; Module width: 15 mm; gray	www.wago.com/286-516
	Item no.: 286-575 Latching relay module; Nominal input voltage: 24 VDC; 1 changeover contact; Limiting continuous current: 3 A; Path; Red status indicator; Module width: 22 mm	www.wago.com/286-575
	Item no.: 286-604/004-000 Timer relay module; Nominal input voltage: 24 VDC; Limiting continuous current: 6 A; On-delay: 10 ... 100 s; Red status indicator; Module width: 20 mm; gray	www.wago.com/286-604/004-000
	Item no.: 286-640 Timer relay module; Nominal input voltage: 24 VDC; Limiting continuous current: 6 A; Path; Multifunction/Multitime; Yellow status indicator; Module width: 6 mm; gray	www.wago.com/286-640
	Item no.: 286-640/004-000 Multifunction timing relay module; Relay with 1 changeover contact (1u); 4 time ranges; for railway operations; 4 functions; gray	www.wago.com/286-640/004-000
	Item no.: 286-661 Current flow monitoring module; AC currents; adjustable; light gray	www.wago.com/286-661
	Item no.: 286-664 Current flow monitoring module; AC currents; Monitoring range: 1 A – 10 A; 1 changeover contact; light gray	www.wago.com/286-664
	Item no.: 286-665 Current flow monitoring module; AC currents; Monitoring range: 1 A – 10 A; 1 changeover contact; light gray	www.wago.com/286-665
	Item no.: 286-742 S0 interface power supply; Input voltage: 230 VAC; S0 interface	www.wago.com/286-742
	Item no.: 286-790 Optocoupler module; gray	www.wago.com/286-790
	Item no.: 286-792 Optocoupler module; Red status indicator; gray	www.wago.com/286-792
	Item no.: 286-807 Component module with diode; with 7 pcs; Diode 1N4007; with common anode; light gray	www.wago.com/286-807

Subject to changes. Please also observe the further product documentation!

	Item no.: 286-809 Component module with diode; light gray	www.wago.com/286-809
	Item no.: 286-822 Component module with LED; Red LED; with common cathode	www.wago.com/286-822
	Item no.: 286-826 AND gate module with 6 inputs; light gray	www.wago.com/286-826
	Item no.: 286-831 Surge suppression module for signal technology; Nominal voltage: 24 VAC/DC; for 2 signal paths with common surge arrester; plugged on rail-mount terminal block, 15 mm wide; gray	www.wago.com/286-831
	Item no.: 286-832 Surge suppression module for signal technology; Nominal voltage: 24 VAC/DC; for 2 signal paths with common surge arrester; pluggable on rail-mount terminal block, 20 mm wide; gray	www.wago.com/286-832
	Item no.: 286-833 Surge suppression module for signal technology; Nominal voltage: 24 VDC; for 1 signal path; plugged on rail-mount terminal block, 15 mm wide; gray	www.wago.com/286-833
	Item no.: 286-834 Surge suppression module for signal technology; Nominal voltage: 12 VDC; for 2 signal paths with common surge arrester; pluggable on rail-mount terminal block, 20 mm wide; gray	www.wago.com/286-834
	Item no.: 286-834/024-000 Surge suppression module for signal technology; Nominal voltage: 24 VDC; for 2 signal paths with common surge arrester; pluggable on rail-mount terminal block, 15 mm wide; gray	www.wago.com/286-834/024-000
	Item no.: 286-841 Surge suppression module for signal technology; Nominal voltage: 220 VDC; for 2 signal paths with common surge arrester; pluggable on rail-mount terminal block, 25 mm wide; gray	www.wago.com/286-841
	Item no.: 286-842 Surge suppression module for signal technology; Nominal voltage: 230 VAC; for 2 signal paths with common surge arrester; pluggable on rail-mount terminal block, 25 mm wide; gray	www.wago.com/286-842
	Item no.: 286-843 Surge suppression module for signal technology; Nominal voltage: 115 VAC; for 2 signal paths with common surge arrester; pluggable on rail-mount terminal block, 25 mm wide; gray	www.wago.com/286-843
	Item no.: 286-844 Surge suppression module for signal technology; for 2 signal paths with common surge arrester; pluggable on rail-mount terminal block, 25 mm wide; gray	www.wago.com/286-844
	Item no.: 769-438 Pin cover; with marker slot for miniature WSB; gray	www.wago.com/769-438
	Item no.: 769-439 Pin cover; with marker slot for miniature WSB; orange	www.wago.com/769-439
	Item no.: 769-501 Start module for 1-conductor female connector; with integrated end plate; 4 mm ² ; 1-pole; 4,00 mm ² ; gray	www.wago.com/769-501
	Item no.: 769-501/000-006 Start module for 1-conductor female connector; 4 mm ² ; 1-pole; 4,00 mm ² ; blue	www.wago.com/769-501/000-006

Subject to changes. Please also observe the further product documentation!

	<p>Item no.: 769-501/000-016 Start module for 1-conductor female connector; with integrated end plate; 4 mm²; 1-pole; 4,00 mm²; green-yellow</p>	www.wago.com/769-501/000-016
	<p>Item no.: 769-502 Center module for 1-conductor female connector; 4 mm²; 1-pole; 4,00 mm²; gray</p>	www.wago.com/769-502
	<p>Item no.: 769-502/000-006 Center module for 1-conductor female connector; 4 mm²; 1-pole; 4,00 mm²; blue</p>	www.wago.com/769-502/000-006
	<p>Item no.: 769-502/000-016 Center module for 1-conductor female connector; 4 mm²; 1-pole; 4,00 mm²; green-yellow</p>	www.wago.com/769-502/000-016
	<p>Item no.: 769-503 End module for 1-conductor female connector; 4 mm²; 1-pole; 4,00 mm²; gray</p>	www.wago.com/769-503
	<p>Item no.: 769-503/000-006 End module for 1-conductor female connector; 4 mm²; 1-pole; 4,00 mm²; blue</p>	www.wago.com/769-503/000-006
	<p>Item no.: 769-503/000-016 End module for 1-conductor female connector; 4 mm²; 1-pole; 4,00 mm²; green-yellow</p>	www.wago.com/769-503/000-016
	<p>Item no.: 769-512 Start module for 1-conductor female connector; angled; 4 mm²; 1-pole; 4,00 mm²; gray</p>	www.wago.com/769-512
	<p>Item no.: 769-512/000-006 Start module for 1-conductor female connector; angled; 4 mm²; 1-pole; 4,00 mm²; blue</p>	www.wago.com/769-512/000-006
	<p>Item no.: 769-512/000-016 Start module for 1-conductor female connector; angled; 4 mm²; 1-pole; 4,00 mm²; green-yellow</p>	www.wago.com/769-512/000-016
	<p>Item no.: 769-513 Center module for 1-conductor female connector; angled; 4 mm²; 1-pole; 4,00 mm²; gray</p>	www.wago.com/769-513
	<p>Item no.: 769-513/000-006 Center module for 1-conductor female connector; angled; 4 mm²; 1-pole; 4,00 mm²; blue</p>	www.wago.com/769-513/000-006
	<p>Item no.: 769-513/000-016 Center module for 1-conductor female connector; angled; 4 mm²; 1-pole; 4,00 mm²; green-yellow</p>	www.wago.com/769-513/000-016
	<p>Item no.: 769-515 End module for 1-conductor female connector; angled; 4 mm²; 1-pole; 4,00 mm²; gray</p>	www.wago.com/769-515
	<p>Item no.: 769-515/000-006 End module for 1-conductor female connector; angled; 4 mm²; 1-pole; 4,00 mm²; blue</p>	www.wago.com/769-515/000-006

Subject to changes. Please also observe the further product documentation!

**Item no.: 769-515/000-016**End module for 1-conductor female connector; angled; 4 mm²; 1-pole; 4,00 mm²; green-yellowwww.wago.com/769-515/000-016**Item no.: 786-102**

Empty component plug housing; Type 15; 20 mm wide; 8-pole; gray

www.wago.com/786-102**Item no.: 786-103**

Empty component plug housing; Type 16; 25 mm wide; 10-pole; gray

www.wago.com/786-103**assembling****Item no.: 209-106**

Mounting carrier; for isolated mounting on DIN 35 rails; gray

www.wago.com/209-106**tools****Item no.: 210-720**

Operating tool; Blade: 3.5 x 0.5 mm; with a partially insulated shaft

www.wago.com/210-720**End plate****Item no.: 769-309**

End and intermediate plate; 1.1 mm thick; gray

www.wago.com/769-309**Item no.: 769-310**

End and intermediate plate; 1.1 mm thick; orange

www.wago.com/769-310**Item no.: 769-313**

Separator plate; 1.1 mm thick; oversized; orange

www.wago.com/769-313**Carrier rail****Item no.: 210-112**

Steel carrier rail; 35 x 7.5 mm; 1 mm thick; 2 m long; slotted; according to EN 60715; "Hole width 25 mm

www.wago.com/210-112**Item no.: 210-113**

Steel carrier rail; 35 x 7.5 mm; 1 mm thick; 2 m long; unslotted; according to EN 60715

www.wago.com/210-113**Item no.: 210-114**

Steel carrier rail; 35 x 15 mm; 1.5 mm thick; 2 m long; unslotted; similar to EN 60715

www.wago.com/210-114**Item no.: 210-115**

Steel carrier rail; 35 x 7.5 mm; 1 mm thick; 2 m long; slotted; according to EN 60715; "Hole width 18 mm

www.wago.com/210-115**Item no.: 210-118**

Steel carrier rail; 35 x 15 mm; 2.3 mm thick; 2 m long; unslotted; according to EN 60715

www.wago.com/210-118**Item no.: 210-196**

Aluminum carrier rail; 35 x 8.2 mm; 1.6 mm thick; 2 m long; unslotted; similar to EN 60715; silver-colored

www.wago.com/210-196**Item no.: 210-197**

Steel carrier rail; 35 x 15 mm; 1.5 mm thick; 2 m long; slotted; similar to EN 60715

www.wago.com/210-197**Item no.: 210-198**

Subject to changes. Please also observe the further product documentation!

WAGO Kontakttechnik GmbH & Co. KG

Hansastr. 27











32423 Minden

Phone: +49571 887-0 | Fax: +49571 887-169

Email: info.de@wago.com | Web: www.wago.com







Do you have any questions about our products?

We are always happy to take your call at +49 (571) 887-44222.

	Copper carrier rail; 35 x 15 mm; 2.3 mm thick; 2 m long; unslotted; according to EN 60715; copper-colored	www.wago.com/210-198
	Item no.: 210-504 Steel carrier rail; 35 x 7.5 mm; 1 mm thick; 2 m long; slotted; galvanized; according to EN 60715	www.wago.com/210-504
	Item no.: 210-505 Steel carrier rail; 35 x 7.5 mm; 1 mm thick; 2 m long; unslotted; galvanized; according to EN 60715	www.wago.com/210-505
	Item no.: 210-506 Steel carrier rail; 35 x 15 mm; 1.5 mm thick; 2 m long; unslotted; galvanized; similar to EN 60715	www.wago.com/210-506
	Item no.: 210-508 Steel carrier rail; 35 x 15 mm; 1.5 mm thick; 2 m long; slotted; galvanized; similar to EN 60715	www.wago.com/210-508
Test Accessories		
	Item no.: 210-137 Test plug; 2.3 mm Ø; with 500 mm cable; yellow	www.wago.com/210-137
	Item no.: 280-404 Test plug adapter; 5 mm wide; for test plug 210-137 (2.3 mm Ø); suitable for 1.5 mm ² - 4 mm ² tbs; gray	www.wago.com/280-404
	Item no.: 280-418 Test plug module; modular; suitable for all WAGO 280 and 780 Series rail-mounted terminal blocks with jumper slots in the current bar; gray	www.wago.com/280-418
	Item no.: 280-419 Spacer module; modular; bridging commoned terminal blocks; gray	www.wago.com/280-419
Jumper		
	Item no.: 249-123 Push-in type wire jumper; insulated; wire length 180 mm; Conductor cross section 0.75 mm ²	www.wago.com/249-123
	Item no.: 249-125 Push-in type wire jumper; insulated; wire length 60 mm; Conductor cross section 0.75 mm ²	www.wago.com/249-125
	Item no.: 249-126 Push-in type wire jumper; insulated; wire length 110 mm; Conductor cross section 0.75 mm ²	www.wago.com/249-126
	Item no.: 249-127 Push-in type wire jumper; insulated; wire length 250 mm; Conductor cross section 0.75 mm ²	www.wago.com/249-127
	Item no.: 280-402 Adjacent jumper; insulated; IN = IN terminal block; gray	www.wago.com/280-402
	Item no.: 280-409 Alternate jumper; insulated; IN = IN terminal block; gray	www.wago.com/280-409
	Item no.: 780-452 Staggered jumper; insulated; from 1 to 2; Spacing: 5 mm; suitable for 2-conductor female plugs; gray	www.wago.com/780-452
	Item no.: 780-453 Staggered jumper; insulated; from 1 to 3; Spacing: 5 mm; suitable for 2-conductor female plugs; gray	www.wago.com/780-453

Subject to changes. Please also observe the further product documentation!



	Item no.: 780-454 Staggered jumper; insulated; from 1 to 4; Spacing: 5 mm; suitable for 2-conductor female plugs; gray	www.wago.com/780-454
	Item no.: 780-455 Staggered jumper; insulated; from 1 to 5; Spacing: 5 mm; suitable for 2-conductor female plugs; gray	www.wago.com/780-455
	Item no.: 780-456 Staggered jumper; insulated; from 1 to 6; Spacing: 5 mm; suitable for 2-conductor female plugs; gray	www.wago.com/780-456
	Item no.: 780-457 Staggered jumper; insulated; from 1 to 7; Spacing: 5 mm; suitable for 2-conductor female plugs; gray	www.wago.com/780-457
	Item no.: 780-458 Staggered jumper; insulated; from 1 to 8; Spacing: 5 mm; suitable for 2-conductor female plugs; gray	www.wago.com/780-458
Coding		
	Item no.: 769-435 Coding pin; for coding of female plugs; for carrier terminal blocks / male connectors; orange	www.wago.com/769-435

Downloads

Documentation

Additional Information

Technical explanations	Apr 3, 2019	pdf 2.1 MB	Download
------------------------	-------------	---------------	----------

CAD/CAE-Data

CAD data

2D/3D Models 769-164/769-313	URL	Download
------------------------------	-----	----------

CAE data

EPLAN Data Portal 769-164/769-313	URL	Download
-----------------------------------	-----	----------

WSCAD Universe 769-164/769-313	URL	Download
--------------------------------	-----	----------

Installation Notes

Assembly

Subject to changes. Please also observe the further product documentation!

WAGO Kontakttechnik GmbH & Co. KG
 Hansastr. 27
 32423 Minden
 Phone: +49571 887-0 | Fax: +49571 887-169
 Email: info.de@wago.com | Web: www.wago.com

Do you have any questions about our products?
 We are always happy to take your call at +49 (571) 887-44222.

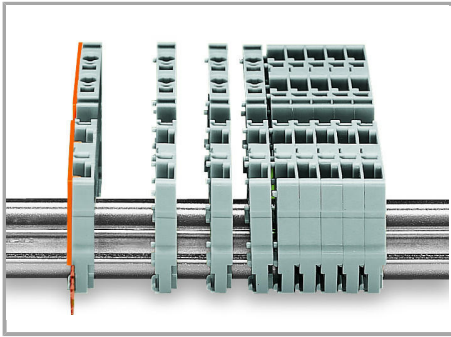

Snap individual carrier terminal blocks onto the carrier rail and slide together.

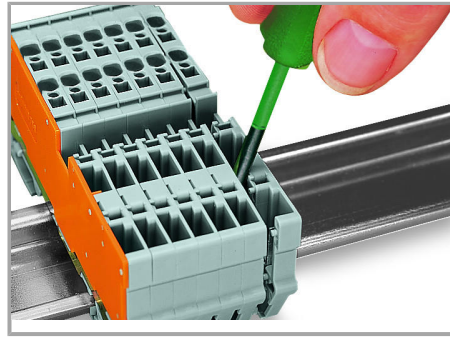

Open the assembly by laterally sliding a block via operating tool and remove terminal block via release lever.

Jumpered

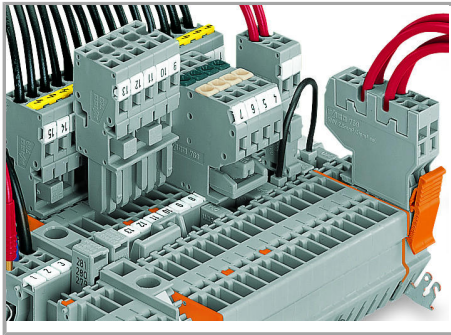

Commoning with adjacent or staggered jumpers –

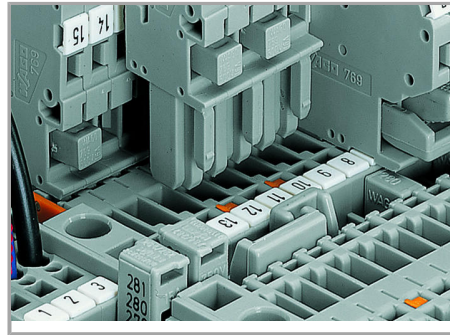

Commoning carrier terminal blocks via staggered jumpers.

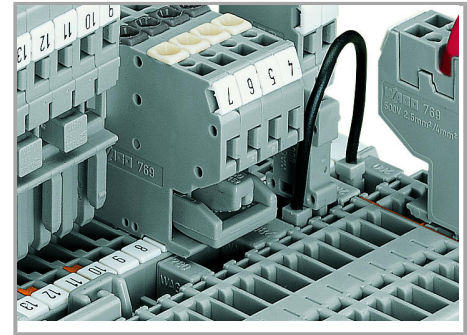

Commoning a 2-conductor female plug via staggered jumper and carrier terminal blocks via adjacent jumpers.

push jumpers down until fully inserted.

Subject to changes. Please also observe the further product documentation!

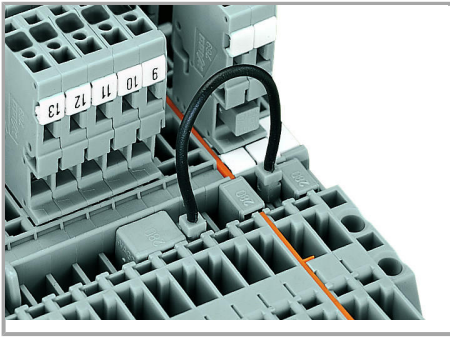

Commoning carrier terminal blocks via push-in type wire jumpers or adjacent jumpers – even over an intermediate plate.

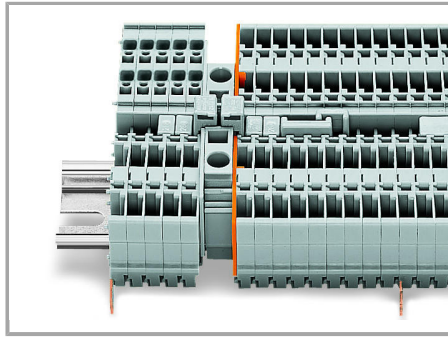

Commoning “supply terminal blocks” (up to 10 mm²/8 AWG) with carrier terminal blocks via step-down jumpers.

Testing

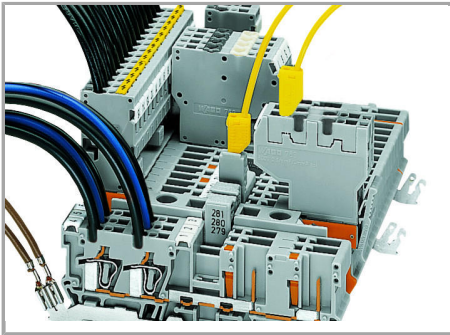

Testing via 2 or 2.3 mm Ø test plugs.

Coding

Subject to changes. Please also observe the further product documentation!

WAGO Kontakttechnik GmbH & Co. KG
Hansastr. 27
32423 Minden
Phone: +49571 887-0 | Fax: +49571 887-169
Email: info.de@wago.com | Web: www.wago.com

Do you have any questions about our products?
We are always happy to take your call at +49 (571) 887-44222.

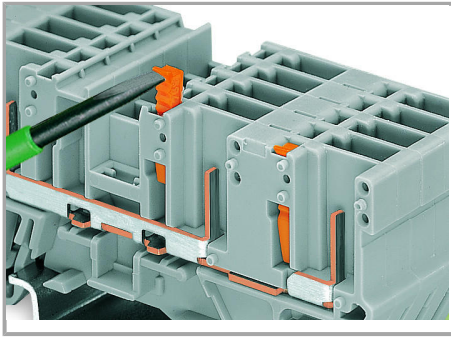

Snap coding pin in proper direction on carrier terminal block.

Shown: Coding pin removal from carrier terminal block.

Locking

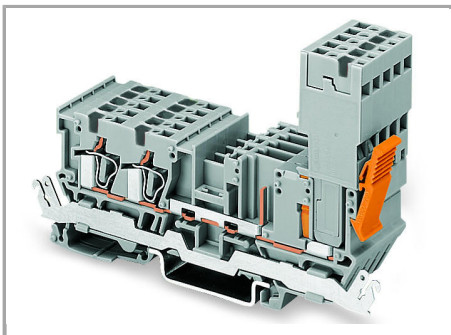

Female plug secured with locking lever on the terminal block side.

Subject to changes. Please also observe the further product documentation!

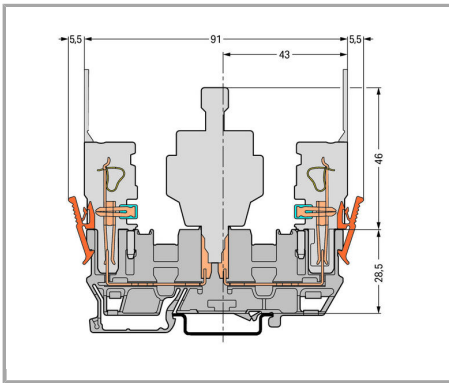

Carrier terminal block

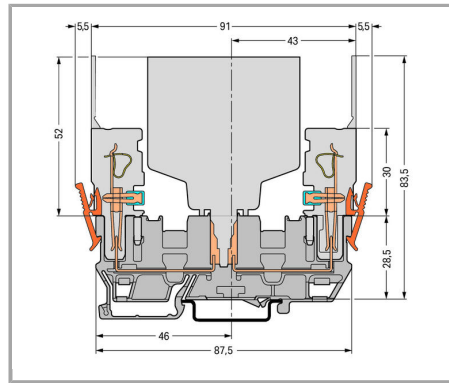

Carrier terminal block

For other dimensions, see 769-151 Carrier Terminal Block.

Product family

X-COM

[Learn more about the product family.](#)

[Show all products from the family](#)

Subject to changes. Please also observe the further product documentation!