

Data sheet | Item number: 769-162/769-313

2-pin terminal block for pluggable modules; 4-pole; with 2 jumper positions; with orange separator plate; for DIN-rail 35 x 15 and 35 x 7.5; 4,00 mm²; gray

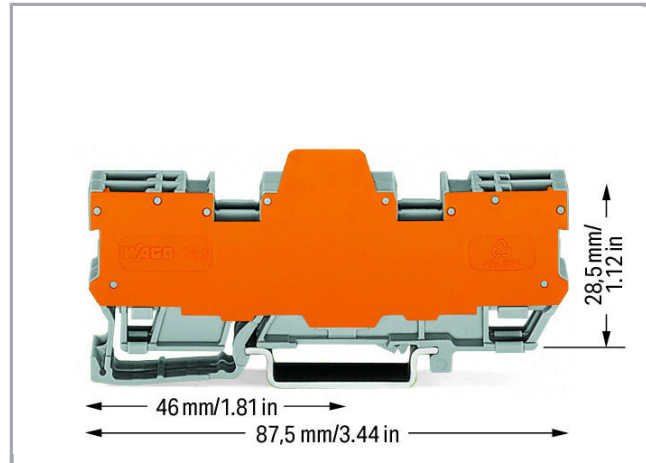

www.wago.com/769-162/769-313

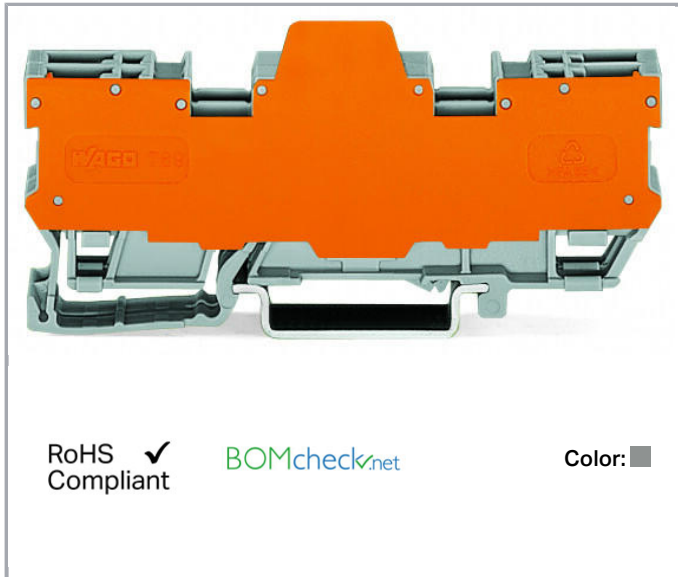

RoHS Compliant

[BOMcheck.net](https://www.bomcheck.net)

Color: ■

Item description

Safety information 1:

2-conductor female plugs cannot be used.

Data

Electrical data

Ratings per IEC/EN 60664-1

Rated voltage (III / 3)	400 V
Rated impulse voltage (III / 3)	6 kV
Rated current	16 A
Legend (ratings)	(III / 3) ≙ Overvoltage category III / Pollution degree 3

Connection data

No. of poles	4
Total number of potentials	4
Number of levels	1

Subject to changes. Please also observe the further product documentation!

WAGO Kontakttechnik GmbH & Co. KG
Hansastr. 27
32423 Minden
Phone: +49571 887-0 | Fax: +49571 887-169
Email: info.de@wago.com | Web: www.wago.com

Do you have any questions about our products?
We are always happy to take your call at +49 (571) 887-44222.



Type of wiring

Front-entry wiring

Geometrical Data

Width	11,1 mm / 0.437 inch
Height from upper-edge of DIN-35 rail	28,5 mm / 1.122 inch
Depth	87,5 mm / 3.445 inch

Mechanical data

Design	horizontal type
Type of mounting	DIN-35 rail
Marking level	Center marking



Material Data

Color	gray
Insulating material	Polyamide 66 (PA 66)
Fire load	0.402 MJ
Weight	17.7 g

Commercial data

Product Group	18 (X-COM-System)
Packaging type	BOX
Country of origin	DE
GTIN	4044918630146
Customs Tariff No.	85369010000

Approvals / Certificates**Country specific Approvals**

Logo	Approval	Additional Approval Text	Certificate name
	CCA DEKRA Certification B.V.	EN 60947	NTR NL-7626
	CSA DEKRA Certification B.V.	C22.2 No. 158	1101144
	KEMA/KEUR	EN 60947	2190419.01

Subject to changes. Please also observe the further product documentation!



WAGO Kontakttechnik GmbH & Co. KG
Hansastr. 27
32423 Minden
Phone: +49571 887-0 | Fax: +49571 887-169
Email: info.de@wago.com | Web: www.wago.com

Do you have any questions about our products?
We are always happy to take your call at +49 (571) 887-44222.



DEKRA Certification B.V.



Ship Approvals

Logo	Approval	Additional Approval Text	Certificate name
	ABS American Bureau of Shipping	EN 60947	20-HG1941090-PDA
	DNV GL Det Norske Veritas, Germanischer Lloyd	-	TAE00001V2

UL-Approvals

Logo	Approval	Additional Approval Text	Certificate name
	UR Underwriters Laboratories Inc.	UL 1059	20190731-E45172
	UR Underwriters Laboratories Inc.	UL 1977	20151210-E45171

Counterpart



Item no.769-102

1-conductor female plug; 4 mm²; 2-pole; 4,00 mm²; gray

www.wago.com/769-102

Subject to changes. Please also observe the further product documentation!









Item no.769-102/022-000

1-conductor female plug; angled; 4 mm²; 2-pole; 4,00 mm²; gray









www.wago.com/769-102/022-000

Compatible products













Female plug

	Item no.: 769-101 1-conductor female plug; 4 mm ² ; 1-pole; 4,00 mm ² ; gray	www.wago.com/769-101
	Item no.: 769-101/000-006 1-conductor female plug; 4 mm ² ; 1-pole; 4,00 mm ² ; blue	www.wago.com/769-101/000-006
	Item no.: 769-101/000-016 1-conductor female plug; 4 mm ² ; 1-pole; 4,00 mm ² ; green-yellow	www.wago.com/769-101/000-016
	Item no.: 769-101/022-000 1-conductor female plug; angled; 4 mm ² ; 1-pole; 4,00 mm ² ; gray	www.wago.com/769-101/022-000
	Item no.: 769-101/022-016 1-conductor female plug; angled; 4 mm ² ; 1-pole; 4,00 mm ² ; green-yellow	www.wago.com/769-101/022-016
	Item no.: 769-102/000-006 1-conductor female plug; 4 mm ² ; 2-pole; 4,00 mm ² ; blue	www.wago.com/769-102/000-006
	Item no.: 769-102/000-036 1-conductor female plug; 4 mm ² ; 2-pole; 4,00 mm ² ; gray, green-yellow	www.wago.com/769-102/000-036
	Item no.: 769-102/000-037 1-conductor female plug; 4 mm ² ; 2-pole; 4,00 mm ² ; green-yellow, gray	www.wago.com/769-102/000-037











Subject to changes. Please also observe the further product documentation!

	<p>Item no.: 769-103 1-conductor female plug; 4 mm²; 3-pole; 4,00 mm²; gray</p>	www.wago.com/769-103
	<p>Item no.: 769-103/000-006 1-conductor female plug; 4 mm²; 3-pole; 4,00 mm²; blue</p>	www.wago.com/769-103/000-006
	<p>Item no.: 769-103/000-036 1-conductor female plug; 4 mm²; 3-pole; 4,00 mm²; gray, green-yellow</p>	www.wago.com/769-103/000-036
	<p>Item no.: 769-103/000-037 1-conductor female plug; 4 mm²; 3-pole; 4,00 mm²; green-yellow, gray</p>	www.wago.com/769-103/000-037
	<p>Item no.: 769-103/000-038 1-conductor female plug; 4 mm²; 3-pole; 4,00 mm²; gray, blue, green-yellow</p>	www.wago.com/769-103/000-038
	<p>Item no.: 769-103/000-039 1-conductor female plug; 4 mm²; 3-pole; 4,00 mm²; green-yellow, blue, gray</p>	www.wago.com/769-103/000-039
	<p>Item no.: 769-103/022-000 1-conductor female plug; angled; 4 mm²; 3-pole; 4,00 mm²; gray</p>	www.wago.com/769-103/022-000
	<p>Item no.: 769-104 1-conductor female plug; 4 mm²; 4-pole; 4,00 mm²; gray</p>	www.wago.com/769-104
	<p>Item no.: 769-104/000-006 1-conductor female plug; 4 mm²; 4-pole; 4,00 mm²; blue</p>	www.wago.com/769-104/000-006
	<p>Item no.: 769-104/000-036 1-conductor female plug; 4 mm²; 4-pole; 4,00 mm²; gray, green-yellow</p>	www.wago.com/769-104/000-036
	<p>Item no.: 769-104/000-037 1-conductor female plug; 4 mm²; 4-pole; 4,00 mm²; green-yellow, gray</p>	www.wago.com/769-104/000-037
	<p>Item no.: 769-104/000-038 1-conductor female plug; 4 mm²; 4-pole; 4,00 mm²; gray, blue, green-yellow</p>	www.wago.com/769-104/000-038
	<p>Item no.: 769-104/000-039 1-conductor female plug; 4 mm²; 4-pole; 4,00 mm²; green-yellow, blue, gray</p>	www.wago.com/769-104/000-039
	<p>Item no.: 769-104/022-000 1-conductor female plug; angled; 4 mm²; 4-pole; 4,00 mm²; gray</p>	www.wago.com/769-104/022-000















Subject to changes. Please also observe the further product documentation!

	Item no.: 769-105 1-conductor female plug; 4 mm ² ; 5-pole; 4,00 mm ² ; gray	www.wago.com/769-105
	Item no.: 769-105/000-006 1-conductor female plug; 4 mm ² ; 5-pole; 4,00 mm ² ; blue	www.wago.com/769-105/000-006
	Item no.: 769-105/000-036 1-conductor female plug; 4 mm ² ; 5-pole; 4,00 mm ² ; gray, green-yellow	www.wago.com/769-105/000-036
	Item no.: 769-105/000-037 1-conductor female plug; 4 mm ² ; 5-pole; 4,00 mm ² ; green-yellow, gray	www.wago.com/769-105/000-037
	Item no.: 769-105/000-038 1-conductor female plug; 4 mm ² ; 5-pole; 4,00 mm ² ; gray, blue, green-yellow	www.wago.com/769-105/000-038
	Item no.: 769-105/000-039 1-conductor female plug; 4 mm ² ; 5-pole; 4,00 mm ² ; green-yellow, blue, gray	www.wago.com/769-105/000-039
	Item no.: 769-105/022-000 1-conductor female plug; angled; 4 mm ² ; 5-pole; 4,00 mm ² ; gray	www.wago.com/769-105/022-000
	Item no.: 769-106 1-conductor female plug; 4 mm ² ; 6-pole; 4,00 mm ² ; gray	www.wago.com/769-106
	Item no.: 769-106/000-006 1-conductor female plug; 4 mm ² ; 6-pole; 4,00 mm ² ; blue	www.wago.com/769-106/000-006
	Item no.: 769-106/000-036 1-conductor female plug; 4 mm ² ; 6-pole; 4,00 mm ² ; gray, green-yellow	www.wago.com/769-106/000-036
	Item no.: 769-106/000-037 1-conductor female plug; 4 mm ² ; 6-pole; 4,00 mm ² ; green-yellow, gray	www.wago.com/769-106/000-037
	Item no.: 769-106/000-038 1-conductor female plug; 4 mm ² ; 6-pole; 4,00 mm ² ; gray, blue, green-yellow	www.wago.com/769-106/000-038
	Item no.: 769-106/000-039 1-conductor female plug; 4 mm ² ; 6-pole; 4,00 mm ² ; green-yellow, blue, gray	www.wago.com/769-106/000-039
	Item no.: 769-106/022-000 1-conductor female plug; angled; 4 mm ² ; 6-pole; 4,00 mm ² ; gray	www.wago.com/769-106/022-000















Subject to changes. Please also observe the further product documentation!

	<p>Item no.: 769-107 1-conductor female plug; 4 mm²; 7-pole; 4,00 mm²; gray</p>	www.wago.com/769-107
	<p>Item no.: 769-107/000-006 1-conductor female plug; 4 mm²; 7-pole; 4,00 mm²; blue</p>	www.wago.com/769-107/000-006
	<p>Item no.: 769-107/000-036 1-conductor female plug; 4 mm²; 7-pole; 4,00 mm²; gray, green-yellow</p>	www.wago.com/769-107/000-036
	<p>Item no.: 769-107/000-037 1-conductor female plug; 4 mm²; 7-pole; 4,00 mm²; green-yellow, gray</p>	www.wago.com/769-107/000-037
	<p>Item no.: 769-107/000-038 1-conductor female plug; 4 mm²; 7-pole; 4,00 mm²; gray, blue, green-yellow</p>	www.wago.com/769-107/000-038
	<p>Item no.: 769-107/000-039 1-conductor female plug; 4 mm²; 7-pole; 4,00 mm²; green-yellow, blue, gray</p>	www.wago.com/769-107/000-039
	<p>Item no.: 769-107/022-000 1-conductor female plug; angled; 4 mm²; 7-pole; 4,00 mm²; gray</p>	www.wago.com/769-107/022-000
	<p>Item no.: 769-108 1-conductor female plug; 4 mm²; 8-pole; 4,00 mm²; gray</p>	www.wago.com/769-108
	<p>Item no.: 769-108/000-006 1-conductor female plug; 4 mm²; 8-pole; 4,00 mm²; blue</p>	www.wago.com/769-108/000-006
	<p>Item no.: 769-108/000-036 1-conductor female plug; 4 mm²; 8-pole; 4,00 mm²; gray, green-yellow</p>	www.wago.com/769-108/000-036
	<p>Item no.: 769-108/000-037 1-conductor female plug; 4 mm²; 8-pole; 4,00 mm²; green-yellow, gray</p>	www.wago.com/769-108/000-037
	<p>Item no.: 769-108/000-038 1-conductor female plug; 4 mm²; 8-pole; 4,00 mm²; gray, blue, green-yellow</p>	www.wago.com/769-108/000-038
	<p>Item no.: 769-108/000-039 1-conductor female plug; 4 mm²; 8-pole; 4,00 mm²; green-yellow, blue, gray</p>	www.wago.com/769-108/000-039
	<p>Item no.: 769-108/022-000 1-conductor female plug; angled; 4 mm²; 8-pole; 4,00 mm²; gray</p>	www.wago.com/769-108/022-000















Subject to changes. Please also observe the further product documentation!

	Item no.: 769-109 1-conductor female plug; 4 mm ² ; 9-pole; 4,00 mm ² ; gray	www.wago.com/769-109
	Item no.: 769-109/000-006 1-conductor female plug; 4 mm ² ; 9-pole; 4,00 mm ² ; blue	www.wago.com/769-109/000-006
	Item no.: 769-109/000-036 1-conductor female plug; 4 mm ² ; 9-pole; 4,00 mm ² ; gray, green-yellow	www.wago.com/769-109/000-036
	Item no.: 769-109/000-037 1-conductor female plug; 4 mm ² ; 9-pole; 4,00 mm ² ; green-yellow, gray	www.wago.com/769-109/000-037
	Item no.: 769-109/000-038 1-conductor female plug; 4 mm ² ; 9-pole; 4,00 mm ² ; gray, blue, green-yellow	www.wago.com/769-109/000-038
	Item no.: 769-109/000-039 1-conductor female plug; 4 mm ² ; 9-pole; 4,00 mm ² ; green-yellow, blue, gray	www.wago.com/769-109/000-039
	Item no.: 769-109/022-000 1-conductor female plug; angled; 4 mm ² ; 9-pole; 4,00 mm ² ; gray	www.wago.com/769-109/022-000
	Item no.: 769-110 1-conductor female plug; 4 mm ² ; 10-pole; 4,00 mm ² ; gray	www.wago.com/769-110
	Item no.: 769-110/000-006 1-conductor female plug; 4 mm ² ; 10-pole; 4,00 mm ² ; blue	www.wago.com/769-110/000-006
	Item no.: 769-110/000-036 1-conductor female plug; 4 mm ² ; 10-pole; 4,00 mm ² ; gray, green-yellow	www.wago.com/769-110/000-036
	Item no.: 769-110/000-037 1-conductor female plug; 4 mm ² ; 10-pole; 4,00 mm ² ; green-yellow, gray	www.wago.com/769-110/000-037
	Item no.: 769-110/000-038 1-conductor female plug; 4 mm ² ; 10-pole; 4,00 mm ² ; gray, blue, green-yellow	www.wago.com/769-110/000-038
	Item no.: 769-110/000-039 1-conductor female plug; 4 mm ² ; 10-pole; 4,00 mm ² ; green-yellow, blue, gray	www.wago.com/769-110/000-039
	Item no.: 769-110/022-000 1-conductor female plug; angled; 4 mm ² ; 10-pole; 4,00 mm ² ; gray	www.wago.com/769-110/022-000

Subject to changes. Please also observe the further product documentation!

	<p>Item no.: 769-111 1-conductor female plug; 4 mm²; 11-pole; 4,00 mm²; gray</p>	www.wago.com/769-111
	<p>Item no.: 769-111/000-006 1-conductor female plug; 4 mm²; 11-pole; 4,00 mm²; blue</p>	www.wago.com/769-111/000-006
	<p>Item no.: 769-111/000-036 1-conductor female plug; 4 mm²; 11-pole; 4,00 mm²; gray, green-yellow</p>	www.wago.com/769-111/000-036
	<p>Item no.: 769-111/000-037 1-conductor female plug; 4 mm²; 11-pole; 4,00 mm²; green-yellow, gray</p>	www.wago.com/769-111/000-037
	<p>Item no.: 769-111/000-038 1-conductor female plug; 4 mm²; 11-pole; 4,00 mm²; gray, blue, green-yellow</p>	www.wago.com/769-111/000-038
	<p>Item no.: 769-111/000-039 1-conductor female plug; 4 mm²; 11-pole; 4,00 mm²; green-yellow, blue, gray</p>	www.wago.com/769-111/000-039
	<p>Item no.: 769-111/022-000 1-conductor female plug; angled; 4 mm²; 11-pole; 4,00 mm²; gray</p>	www.wago.com/769-111/022-000
	<p>Item no.: 769-112 1-conductor female plug; 4 mm²; 12-pole; 4,00 mm²; gray</p>	www.wago.com/769-112
	<p>Item no.: 769-112/000-006 1-conductor female plug; 4 mm²; 12-pole; 4,00 mm²; blue</p>	www.wago.com/769-112/000-006
	<p>Item no.: 769-112/000-036 1-conductor female plug; 4 mm²; 12-pole; 4,00 mm²; gray, green-yellow</p>	www.wago.com/769-112/000-036
	<p>Item no.: 769-112/000-037 1-conductor female plug; 4 mm²; 12-pole; 4,00 mm²; green-yellow, gray</p>	www.wago.com/769-112/000-037
	<p>Item no.: 769-112/000-038 1-conductor female plug; 4 mm²; 12-pole; 4,00 mm²; gray, blue, green-yellow</p>	www.wago.com/769-112/000-038
	<p>Item no.: 769-112/000-039 1-conductor female plug; 4 mm²; 12-pole; 4,00 mm²; green-yellow, blue, gray</p>	www.wago.com/769-112/000-039
	<p>Item no.: 769-112/022-000 1-conductor female plug; angled; 4 mm²; 12-pole; 4,00 mm²; gray</p>	www.wago.com/769-112/022-000

Subject to changes. Please also observe the further product documentation!

	Item no.: 769-113 1-conductor female plug; 4 mm ² ; 13-pole; 4,00 mm ² ; gray	www.wago.com/769-113
	Item no.: 769-113/000-036 1-conductor female plug; 4 mm ² ; 13-pole; 4,00 mm ² ; gray, green-yellow	www.wago.com/769-113/000-036
	Item no.: 769-113/000-037 1-conductor female plug; 4 mm ² ; 13-pole; 4,00 mm ² ; green-yellow, gray	www.wago.com/769-113/000-037
	Item no.: 769-113/000-038 1-conductor female plug; 4 mm ² ; 13-pole; 4,00 mm ² ; gray, blue, green-yellow	www.wago.com/769-113/000-038
	Item no.: 769-113/000-039 1-conductor female plug; 4 mm ² ; 13-pole; 4,00 mm ² ; green-yellow, blue, gray	www.wago.com/769-113/000-039
	Item no.: 769-113/022-000 1-conductor female plug; angled; 4 mm ² ; 13-pole; 4,00 mm ² ; gray	www.wago.com/769-113/022-000
	Item no.: 769-114 1-conductor female plug; 4 mm ² ; 14-pole; 4,00 mm ² ; gray	www.wago.com/769-114
	Item no.: 769-114/000-006 1-conductor female plug; 4 mm ² ; 14-pole; 4,00 mm ² ; blue	www.wago.com/769-114/000-006
	Item no.: 769-114/000-036 1-conductor female plug; 4 mm ² ; 14-pole; 4,00 mm ² ; gray, green-yellow	www.wago.com/769-114/000-036
	Item no.: 769-114/000-037 1-conductor female plug; 4 mm ² ; 14-pole; 4,00 mm ² ; green-yellow, gray	www.wago.com/769-114/000-037
	Item no.: 769-114/000-038 1-conductor female plug; 4 mm ² ; 14-pole; 4,00 mm ² ; gray, blue, green-yellow	www.wago.com/769-114/000-038
	Item no.: 769-114/000-039 1-conductor female plug; 4 mm ² ; 14-pole; 4,00 mm ² ; green-yellow, blue, gray	www.wago.com/769-114/000-039
	Item no.: 769-114/022-000 1-conductor female plug; angled; 4 mm ² ; 14-pole; 4,00 mm ² ; gray	www.wago.com/769-114/022-000
	Item no.: 769-115 1-conductor female plug; 4 mm ² ; 15-pole; 4,00 mm ² ; gray	www.wago.com/769-115

Subject to changes. Please also observe the further product documentation!



Item no.: 769-115/000-036
1-conductor female plug; 4 mm²; 15-pole; 4,00 mm²; gray, green-yellow

www.wago.com/769-115/000-036



Item no.: 769-115/000-037
1-conductor female plug; 4 mm²; 15-pole; 4,00 mm²; green-yellow, gray

www.wago.com/769-115/000-037



Item no.: 769-115/000-038
1-conductor female plug; 4 mm²; 15-pole; 4,00 mm²; gray, blue, green-yellow

www.wago.com/769-115/000-038



Item no.: 769-115/000-039
1-conductor female plug; 4 mm²; 15-pole; 4,00 mm²; green-yellow, blue, gray

www.wago.com/769-115/000-039



Item no.: 769-115/022-000
1-conductor female plug; angled; 4 mm²; 15-pole; 4,00 mm²; gray

www.wago.com/769-115/022-000

Carrier rail



Item no.: 210-112
Steel carrier rail; 35 x 7.5 mm; 1 mm thick; 2 m long; slotted; according to EN 60715; "Hole width 25 mm" www.wago.com/210-112

Item no.: 210-113
Steel carrier rail; 35 x 7.5 mm; 1 mm thick; 2 m long; unslotted; according to EN 60715 www.wago.com/210-113

Item no.: 210-114
Steel carrier rail; 35 x 15 mm; 1.5 mm thick; 2 m long; unslotted; similar to EN 60715 www.wago.com/210-114



Item no.: 210-115
Steel carrier rail; 35 x 7.5 mm; 1 mm thick; 2 m long; slotted; according to EN 60715; "Hole width 18 mm" www.wago.com/210-115



Item no.: 210-118
Steel carrier rail; 35 x 15 mm; 2.3 mm thick; 2 m long; unslotted; according to EN 60715 www.wago.com/210-118

Item no.: 210-196
Aluminum carrier rail; 35 x 8.2 mm; 1.6 mm thick; 2 m long; unslotted; similar to EN 60715; silver-colored www.wago.com/210-196



Item no.: 210-197
Steel carrier rail; 35 x 15 mm; 1.5 mm thick; 2 m long; slotted; similar to EN 60715 www.wago.com/210-197



Item no.: 210-198
Copper carrier rail; 35 x 15 mm; 2.3 mm thick; 2 m long; unslotted; according to EN 60715; copper-colored www.wago.com/210-198



Item no.: 210-504
Steel carrier rail; 35 x 7.5 mm; 1 mm thick; 2 m long; slotted; galvanized; according to EN 60715 www.wago.com/210-504

Item no.: 210-505
Steel carrier rail; 35 x 7.5 mm; 1 mm thick; 2 m long; unslotted; galvanized; according to EN 60715 www.wago.com/210-505

Item no.: 210-506

Subject to changes. Please also observe the further product documentation!

Steel carrier rail; 35 x 15 mm; 1.5 mm thick; 2 m long; unslotted; galvanized; similar to EN 60715

www.wago.com/210-506



Item no.: 210-508

Steel carrier rail; 35 x 15 mm; 1.5 mm thick; 2 m long; slotted; galvanized; similar to EN 60715

www.wago.com/210-508

tools



Item no.: 210-720

Operating tool; Blade: 3.5 x 0.5 mm; with a partially insulated shaft

www.wago.com/210-720

Marking accessories

Item no.: 2009-145

Mini-WSB Inline; for Smart Printer; 1700 pieces on roll; stretchable 5 - 5.2 mm; plain; snap-on type; white

www.wago.com/2009-145

Item no.: 2009-145/000-002

Mini-WSB Inline; for Smart Printer; 1700 pieces on roll; stretchable 5 - 5.2 mm; plain; snap-on type; white

www.wago.com/2009-145/000-002



Item no.: 2009-145/000-005

Mini-WSB Inline; for Smart Printer; 1700 pieces on roll; stretchable 5 - 5.2 mm; plain; snap-on type; red

www.wago.com/2009-145/000-005



Item no.: 2009-145/000-006

Mini-WSB Inline; for Smart Printer; 1700 pieces on roll; stretchable 5 - 5.2 mm; plain; snap-on type; blue

www.wago.com/2009-145/000-006



Item no.: 2009-145/000-007

Mini-WSB Inline; for Smart Printer; 1700 pieces on roll; stretchable 5 - 5.2 mm; plain; snap-on type; white

www.wago.com/2009-145/000-007



Item no.: 2009-145/000-012

Mini-WSB Inline; for Smart Printer; 1700 pieces on roll; stretchable 5 - 5.2 mm; plain; snap-on type; orange

www.wago.com/2009-145/000-012



Item no.: 2009-145/000-023

Mini-WSB Inline; for Smart Printer; 1700 pieces on roll; stretchable 5 - 5.2 mm; plain; snap-on type; green

www.wago.com/2009-145/000-023

Item no.: 2009-145/000-024

Mini-WSB Inline; for Smart Printer; 1700 pieces on roll; stretchable 5 - 5.2 mm; plain; snap-on type; violet

www.wago.com/2009-145/000-024



Item no.: 248-501

Miniature WSB Quick marking system; plain; Marker width 5 mm; 10 strips with 10 markers per card

www.wago.com/248-501



Item no.: 248-501/000-002

Mini-WSB marking card; as card; not stretchable; plain; snap-on type; yellow

www.wago.com/248-501/000-002

Item no.: 248-501/000-005

Mini-WSB marking card; as card; not stretchable; plain; snap-on type; red

www.wago.com/248-501/000-005

Subject to changes. Please also observe the further product documentation!

WAGO Kontakttechnik GmbH & Co. KG

Hansastr. 27

32423 Minden

Phone: +49571 887-0 | Fax: +49571 887-169

Email: info.de@wago.com | Web: www.wago.com

Do you have any questions about our products?

We are always happy to take your call at +49 (571) 887-44222.



Item no.: 248-501/000-006
Mini-WSB marking card; as card; not stretchable; plain; snap-on type; blue

www.wago.com/248-501/000-006

Item no.: 248-501/000-007
Mini-WSB marking card; as card; not stretchable; plain; snap-on type; gray

www.wago.com/248-501/000-007

Item no.: 248-501/000-012
Mini-WSB marking card; as card; not stretchable; plain; snap-on type; orange

www.wago.com/248-501/000-012

Item no.: 248-501/000-017
Mini-WSB marking card; as card; not stretchable; plain; snap-on type; light green

www.wago.com/248-501/000-017



Item no.: 248-501/000-023
Mini-WSB marking card; as card; not stretchable; plain; snap-on type; green

www.wago.com/248-501/000-023

Item no.: 248-501/000-024
Mini-WSB marking card; as card; not stretchable; plain; snap-on type; violet

www.wago.com/248-501/000-024

Coding



Item no.: 769-435
Coding pin; for coding of female plugs; for carrier terminal blocks / male connectors; orange

www.wago.com/769-435

End plate



Item no.: 769-309
End and intermediate plate; 1.1 mm thick; gray

www.wago.com/769-309



Item no.: 769-310
End and intermediate plate; 1.1 mm thick; orange

www.wago.com/769-310



Item no.: 769-313
Separator plate; 1.1 mm thick; oversized; orange

www.wago.com/769-313

Test Accessories



Item no.: 210-137
Test plug; 2.3 mm Ø; with 500 mm cable; yellow

www.wago.com/210-137

Item no.: 280-404
Test plug adapter; 5 mm wide; for test plug 210-137 (2.3 mm Ø); suitable for 1.5 mm² - 4 mm² tbs; gray

www.wago.com/280-404



Item no.: 280-418
Test plug module; modular; suitable for all WAGO 280 and 780 Series rail-mounted terminal blocks with jumper slots in the current bar; gray

www.wago.com/280-418

Item no.: 280-419
Spacer module; modular; bridging commoned terminal blocks; gray

www.wago.com/280-419

assembling

Subject to changes. Please also observe the further product documentation!



Item no.: 209-106
Mounting carrier; for isolated mounting on DIN 35 rails; gray

www.wago.com/209-106

Jumper

Item no.: 249-123
Push-in type wire jumper; insulated; wire length 180 mm; Conductor cross section 0.75 mm² www.wago.com/249-123



Item no.: 249-125
Push-in type wire jumper; insulated; wire length 60 mm; Conductor cross section 0.75 mm² www.wago.com/249-125



Item no.: 249-126
Push-in type wire jumper; insulated; wire length 110 mm; Conductor cross section 0.75 mm² www.wago.com/249-126



Item no.: 249-127
Push-in type wire jumper; insulated; wire length 250 mm; Conductor cross section 0.75 mm² www.wago.com/249-127



Item no.: 280-402
Adjacent jumper; insulated; IN = IN terminal block; gray www.wago.com/280-402



Item no.: 280-409
Alternate jumper; insulated; IN = IN terminal block; gray www.wago.com/280-409



Item no.: 780-452
Staggered jumper; insulated; from 1 to 2; Spacing: 5 mm; suitable for 2-conductor female plugs; gray www.wago.com/780-452

Item no.: 780-453
Staggered jumper; insulated; from 1 to 3; Spacing: 5 mm; suitable for 2-conductor female plugs; gray www.wago.com/780-453



Item no.: 780-454
Staggered jumper; insulated; from 1 to 4; Spacing: 5 mm; suitable for 2-conductor female plugs; gray www.wago.com/780-454



Item no.: 780-455
Staggered jumper; insulated; from 1 to 5; Spacing: 5 mm; suitable for 2-conductor female plugs; gray www.wago.com/780-455



Item no.: 780-456
Staggered jumper; insulated; from 1 to 6; Spacing: 5 mm; suitable for 2-conductor female plugs; gray www.wago.com/780-456



Item no.: 780-457
Staggered jumper; insulated; from 1 to 7; Spacing: 5 mm; suitable for 2-conductor female plugs; gray www.wago.com/780-457



Item no.: 780-458
Staggered jumper; insulated; from 1 to 8; Spacing: 5 mm; suitable for 2-conductor female plugs; gray www.wago.com/780-458

General accessories

Item no.: 280-804
Empty component plug housing; 10 mm wide; Type 3; 4-pole; gray www.wago.com/280-804











Item no.: 286-110
Empty component plug housing; Type 9; 10 mm wide; 4-pole; gray www.wago.com/286-110

















Item no.: 286-113
Empty component plug housing; Type 12; 25 mm wide; 10-pole; gray www.wago.com/286-113

Item no.: 286-336/001-000











Subject to changes. Please also observe the further product documentation!

	Relay module; Nominal input voltage: 24 VDC; 2 break and 2 make contacts; Red status indicator; Module width: 25 mm; gray	www.wago.com/286-336/001-000
	Item no.: 286-344/004-000 Relay module; Nominal input voltage: 24 VDC; 3 break contacts and 1 make contact; Path; Red status indicator; Module width: 25 mm; gray	www.wago.com/286-344/004-000
	Item no.: 286-352/004-000 Relay module; Nominal input voltage: 24 VDC; 4 make contacts; Limiting continuous current: 5 A; Path; Red status indicator; Module width: 25 mm; gray	www.wago.com/286-352/004-000
	Item no.: 286-364 Relay module; Nominal input voltage: 24 VDC; 1 make contact; Limiting continuous current: 5 A; Red status indicator; Module width: 10 mm; gray	www.wago.com/286-364
	Item no.: 286-364/004-000 Relay module; Nominal input voltage: 24 VDC; 1 make contact; Path; Red status indicator; Module width: 10 mm; gray	www.wago.com/286-364/004-000
	Item no.: 286-368 Relay module; Nominal input voltage: 24 VDC; 1 break contact; Limiting continuous current: 5 A; Red status indicator; Module width: 10 mm; gray	www.wago.com/286-368
	Item no.: 286-368/004-000 Relay module; Nominal input voltage: 24 VDC; 1 break contact; Path; Red status indicator; Module width: 10 mm	www.wago.com/286-368/004-000
	Item no.: 286-664 Current flow monitoring module; AC currents; Monitoring range: 1 A – 10 A; 1 changeover contact; light gray	www.wago.com/286-664
	Item no.: 286-665 Current flow monitoring module; AC currents; Monitoring range: 1 A – 10 A; 1 changeover contact; light gray	www.wago.com/286-665
	Item no.: 286-742 S0 interface power supply; Input voltage: 230 VAC; S0 interface	www.wago.com/286-742
	Item no.: 286-791 Optocoupler module; Nominal input voltage: 24 VDC; Output voltage range: 20 ... 60 VDC; Limiting continuous current: 0.1 A; 2-wire connection; Frequency: 3 kHz; Red status indicator; Module width: 10 mm; gray	www.wago.com/286-791
	Item no.: 286-794 Optocoupler module; Nominal input voltage: 24 VDC; Output voltage range: 20 ... 60 VDC; Limiting continuous current: 0.1 A; 2-wire connection; Red status indicator; Module width: 10 mm; gray	www.wago.com/286-794
	Item no.: 286-803 Component module with diode; gray	www.wago.com/286-803
	Item no.: 286-809 Component module with diode; light gray	www.wago.com/286-809
	Item no.: 286-822 Component module with LED; Red LED; with common cathode	www.wago.com/286-822

Subject to changes. Please also observe the further product documentation!

	Item no.: 286-826 AND gate module with 6 inputs; light gray	www.wago.com/286-826
	Item no.: 286-841 Surge suppression module for signal technology; Nominal voltage: 220 VDC; for 2 signal paths with common surge arrester; pluggable on rail-mount terminal block, 25 mm wide; gray	www.wago.com/286-841
	Item no.: 286-842 Surge suppression module for signal technology; Nominal voltage: 230 VAC; for 2 signal paths with common surge arrester; pluggable on rail-mount terminal block, 25 mm wide; gray	www.wago.com/286-842
	Item no.: 286-843 Surge suppression module for signal technology; Nominal voltage: 115 VAC; for 2 signal paths with common surge arrester; pluggable on rail-mount terminal block, 25 mm wide; gray	www.wago.com/286-843
	Item no.: 286-844 Surge suppression module for signal technology; for 2 signal paths with common surge arrester; pluggable on rail-mount terminal block, 25 mm wide; gray	www.wago.com/286-844
	Item no.: 286-890 Component module with fuse; for (5 x 20) mm microfuse; Nominal voltage: 24 VAC/DC; gray	www.wago.com/286-890
	Item no.: 286-891 Component module with fuse; for (5 x 20) mm microfuse; Nominal voltage: 230 VAC/DC; gray	www.wago.com/286-891
	Item no.: 769-438 Pin cover; with marker slot for miniature WSB; gray	www.wago.com/769-438
	Item no.: 769-439 Pin cover; with marker slot for miniature WSB; orange	www.wago.com/769-439
	Item no.: 769-501 Start module for 1-conductor female connector; with integrated end plate; 4 mm ² ; 1-pole; 4,00 mm ² ; gray	www.wago.com/769-501
	Item no.: 769-501/000-006 Start module for 1-conductor female connector; 4 mm ² ; 1-pole; 4,00 mm ² ; blue	www.wago.com/769-501/000-006
	Item no.: 769-501/000-016 Start module for 1-conductor female connector; with integrated end plate; 4 mm ² ; 1-pole; 4,00 mm ² ; green-yellow	www.wago.com/769-501/000-016
	Item no.: 769-502 Center module for 1-conductor female connector; 4 mm ² ; 1-pole; 4,00 mm ² ; gray	www.wago.com/769-502
	Item no.: 769-502/000-006 Center module for 1-conductor female connector; 4 mm ² ; 1-pole; 4,00 mm ² ; blue	www.wago.com/769-502/000-006
	Item no.: 769-502/000-016 Center module for 1-conductor female connector; 4 mm ² ; 1-pole; 4,00 mm ² ; green-yellow	www.wago.com/769-502/000-016
	Item no.: 769-503 End module for 1-conductor female connector; 4 mm ² ; 1-pole; 4,00 mm ² ; gray	www.wago.com/769-503

Subject to changes. Please also observe the further product documentation!

	Item no.: 769-503/000-006 End module for 1-conductor female connector; 4 mm ² ; 1-pole; 4,00 mm ² ; blue	www.wago.com/769-503/000-006
	Item no.: 769-503/000-016 End module for 1-conductor female connector; 4 mm ² ; 1-pole; 4,00 mm ² ; green-yellow	www.wago.com/769-503/000-016
	Item no.: 769-512 Start module for 1-conductor female connector; angled; 4 mm ² ; 1-pole; 4,00 mm ² ; gray	www.wago.com/769-512
	Item no.: 769-512/000-006 Start module for 1-conductor female connector; angled; 4 mm ² ; 1-pole; 4,00 mm ² ; blue	www.wago.com/769-512/000-006
	Item no.: 769-512/000-016 Start module for 1-conductor female connector; angled; 4 mm ² ; 1-pole; 4,00 mm ² ; green-yellow	www.wago.com/769-512/000-016
	Item no.: 769-513 Center module for 1-conductor female connector; angled; 4 mm ² ; 1-pole; 4,00 mm ² ; gray	www.wago.com/769-513
	Item no.: 769-513/000-006 Center module for 1-conductor female connector; angled; 4 mm ² ; 1-pole; 4,00 mm ² ; blue	www.wago.com/769-513/000-006
	Item no.: 769-513/000-016 Center module for 1-conductor female connector; angled; 4 mm ² ; 1-pole; 4,00 mm ² ; green-yellow	www.wago.com/769-513/000-016
	Item no.: 769-515 End module for 1-conductor female connector; angled; 4 mm ² ; 1-pole; 4,00 mm ² ; gray	www.wago.com/769-515
	Item no.: 769-515/000-006 End module for 1-conductor female connector; angled; 4 mm ² ; 1-pole; 4,00 mm ² ; blue	www.wago.com/769-515/000-006
	Item no.: 769-515/000-016 End module for 1-conductor female connector; angled; 4 mm ² ; 1-pole; 4,00 mm ² ; green-yellow	www.wago.com/769-515/000-016
	Item no.: 786-103 Empty component plug housing; Type 16; 25 mm wide; 10-pole; gray	www.wago.com/786-103

Downloads

Documentation

Additional Information

Technical explanations	Apr 3, 2019	pdf 2.1 MB	Download
------------------------	-------------	---------------	----------

Subject to changes. Please also observe the further product documentation!

CAD/CAE-Data

CAD data

2D/3D Models 769-162/769-313	URL	Download
------------------------------	---------------------	--------------------------

CAE data

EPLAN Data Portal 769-162/769-313	URL	Download
-----------------------------------	---------------------	--------------------------

WSCAD Universe 769-162/769-313	URL	Download
--------------------------------	---------------------	--------------------------

Installation Notes

Assembly

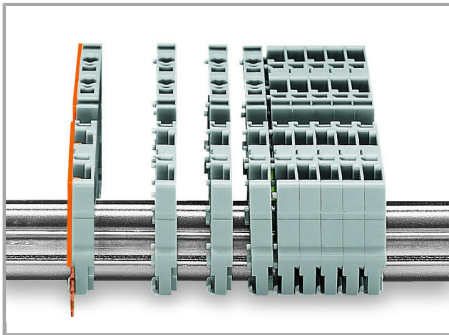

Snap individual carrier terminal blocks onto the carrier rail and slide together.

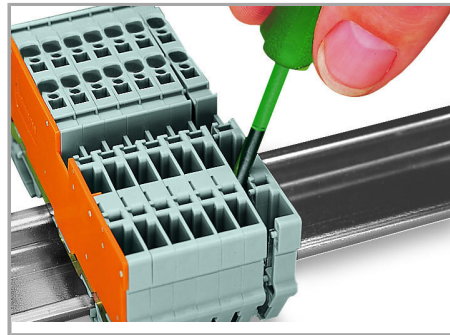

Open the assembly by laterally sliding a block via operating tool and remove terminal block via release lever.

Jumpered

Subject to changes. Please also observe the further product documentation!

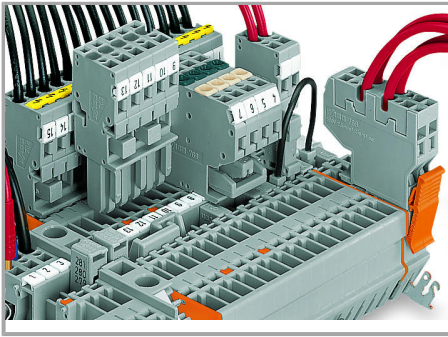

Commoning with adjacent or staggered jumpers –

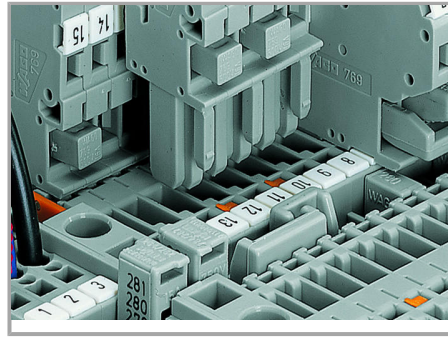

Commoning carrier terminal blocks via staggered jumpers.

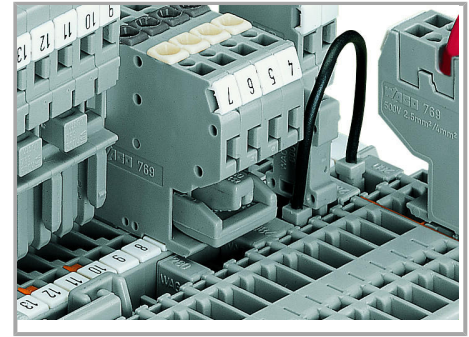

Commoning a 2-conductor female plug via staggered jumper and carrier terminal blocks via adjacent jumpers.

push jumpers down until fully inserted.

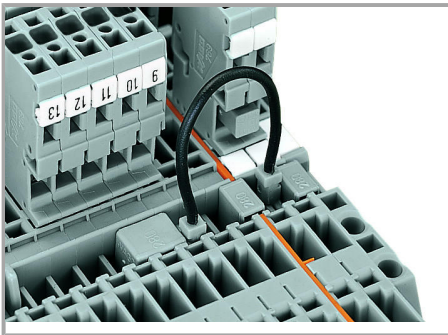

Commoning carrier terminal blocks via push-in type wire jumpers or adjacent jumpers – even over an intermediate plate.

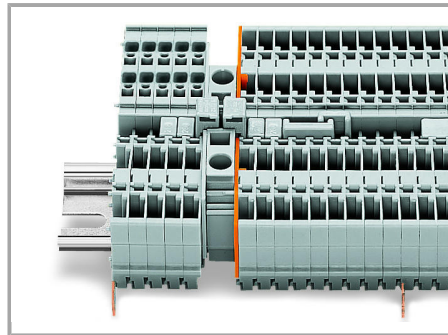

Commoning "supply terminal blocks" (up to 10 mm²/8 AWG) with carrier terminal blocks via step-down jumpers.

Testing

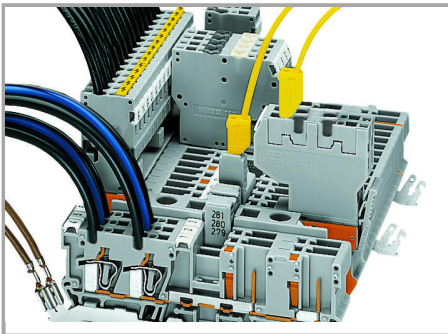

Testing via 2 or 2.3 mm Ø test plugs.

Subject to changes. Please also observe the further product documentation!

Coding

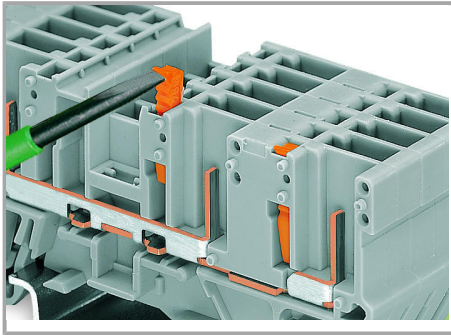

Snap coding pin in proper direction on carrier terminal block.

Shown: Coding pin removal from carrier terminal block.

Locking

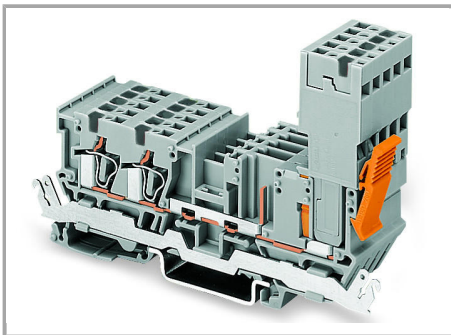

Female plug secured with locking lever on the terminal block side.

Subject to changes. Please also observe the further product documentation!

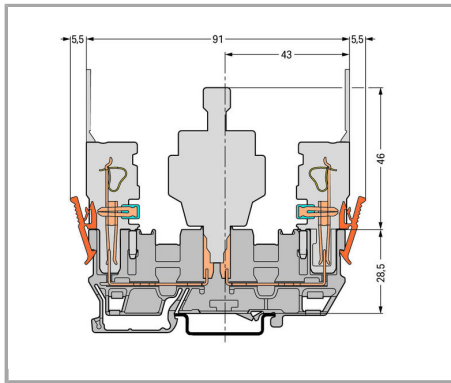

Carrier terminal block

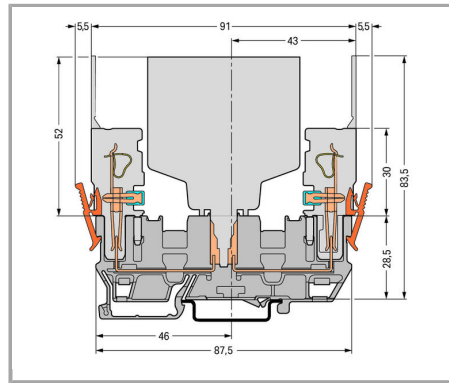

Carrier terminal block

For other dimensions, see 769-151 Carrier Terminal Block.

Product family

X-COM

[Learn more about the product family.](#)

[Show all products from the family](#)

Subject to changes. Please also observe the further product documentation!