

Data sheet | Item number: 756-3202/120-150

Connecting cable; 12-pole; Length: 15 m

www.wago.com/756-3202/120-150



RoHS 
Compliant

[BOMcheck.net](https://www.bomcheck.net)

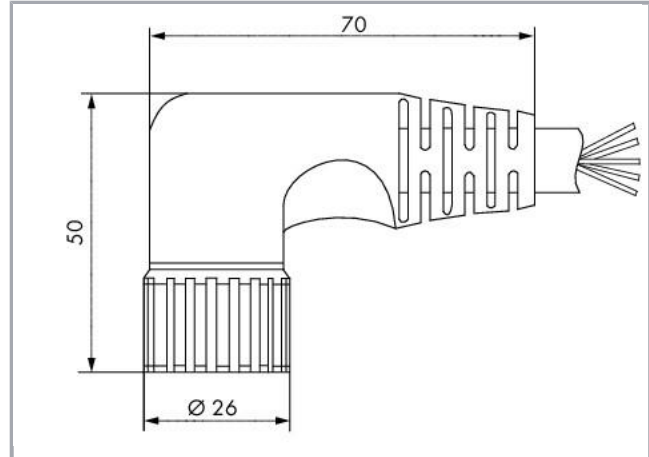

Subject to changes. Please also observe the further product documentation!

WAGO Kontakttechnik GmbH & Co. KG
Hansastr. 27
32423 Minden
Phone: +49571 887-0 | Fax: +49571 887-169
Email: info.de@wago.com | Web: www.wago.com

Do you have any questions about our products?
We are always happy to take your call at +49 (571) 887-44222.

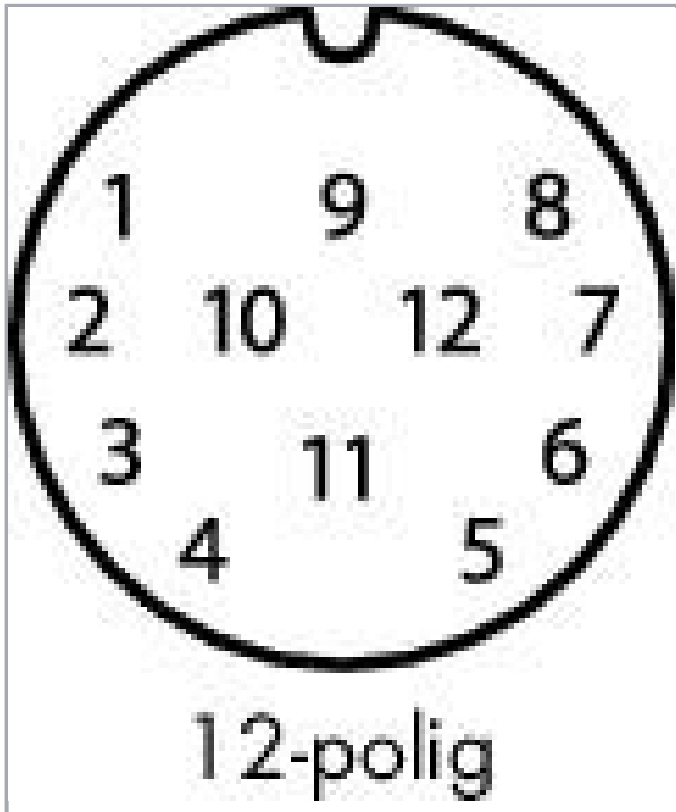

Pin 9, 11, 12: 1.00 mm²;
Pin 1 - 8: 0.34 mm²

1 white	9 blue
2 green	10 commoned with 9
3 yellow	11 brown
4 gray	12 green/yellow
5 pink	
6 red	
7 black	
8 violet	

Data

Technical Data

Connection type	M23 socket - free end
No. of poles	12
Leitungsanschlussrichtung zur Steckrichtung	90°
Cable length	15 m
Operating voltage	≤ 300 V
Operating current	8 A
Rated surge voltage	≥ 2.0 kV rms

Mechanical data

Bending cycles	2 Mio.
Schleppkettentauglichkeit	yes
Cable diameter	9 ... 9,6 mm
Weight	1589 g

Subject to changes. Please also observe the further product documentation!

WAGO Kontakttechnik GmbH & Co. KG
Hansastr. 27
32423 Minden
Phone: +49571 887-0 | Fax: +49571 887-169
Email: info.de@wago.com | Web: www.wago.com

Do you have any questions about our products?
We are always happy to take your call at +49 (571) 887-44222.



Environmental Requirements

Umgebungstemperatur (Betrieb) bewegt	-25 ... +80 °C
Umgebungstemperatur (Betrieb) ruhend	-40 ... +80 °C
Protection class	IP67

Commercial data

Product Group	23 (I/O passive and accessories)
Packaging type	BOX
Country of origin	DE
GTIN	4044918569026
Customs Tariff No.	85444290900

Counterpart

Downloads

Documentation

System Description

Sensor/Actuator Boxes – General Product Information	pdf 537.3 kB	Download
---	-----------------	----------

CAD/CAE-Data

CAE data

WSCAD Universe 756-3202/120-150	URL	Download
---------------------------------	-----	----------

Installation Notes

Subject to changes. Please also observe the further product documentation!